

# Stage 06: Final Grid Code Modification Report

## Grid Code

# GC0101: EU Connection Codes GB Implementation – Mod 2

What stage is this document at?

01	Initial Written Assessment
02	Workgroup Consultation
03	Workgroup Report
04	Code Administrator Consultation
05	Draft Grid Code Modification Report
06	Final Modification Report

This proposal seeks to modify the Grid Code to comply with the obligations in the EU Connection Codes:

1. Set the Voltage & Reactive requirement in GB, as required in RfG; and HVDC; and
2. Set the Frequency requirements in GB, as required in RfG and HVDC

This Final Modification Report has been prepared in accordance with the terms of the Grid Code. An electronic version of this document and all other GC0101 related documentation can be found on the National Grid website via the following link:

<https://www.nationalgrid.com/uk/electricity/codes/grid-code/modifications/eu-connection-codes-gb-implementation-mod-2>

At the Grid Code Panel meeting on 8 February 2018 Panel Members unanimously agreed that the Original was better than the baseline and recommended that it should be implemented.

The purpose of this document is to assist the Authority in making its determination on whether to implement GC0101.

**Published on:** 20 February 2018



### **High Impact:**

Developers of: New generation schemes (800 Watts capacity and up), new HVDC schemes (including DC-connected Power Park Modules); GB NETSO; Distribution Network Operators



### **Medium Impact:**

**Transmission Owners (including OFTOs); Operators of existing generation, HVDC schemes considering modernisation**

## Contents

1	Summary .....	3
2	Original Proposal .....	5
3.	Solution .....	8
	Workgroup Consultation overview.....	22
4.	Workgroup Discussions .....	28
	Workgroup Vote .....	45
5	Alternatives.....	47
6	Impact & Assessment .....	56
7	Relevant Objectives – Initial assessment by Proposer.....	59
8	Implementation.....	61
9	Code Administrator Consultation summary .....	61
10.	Grid Code Panel Views .....	73
	References .....	76
	Annex 1 – Grid Code legal text .....	76
	Annex 2 – Terms of Reference .....	76
	Annex 3 – Workgroup Consultation responses .....	76
	Annex 4 – GC0048 Voltage & Reactive; GC0087 RfG Frequency Consultation Responses.....	77
	Annex 5 – Remote end HVDC Converter Frequency Response parameters Title III.....	93
	Annex 6 – HVDC Frequency Response Parameters Title II.....	93
	Annex 7 – Mapping for Grid Code (and Distribution Code) .....	93
	Annex 8 – DC Connected Power Park Modules Frequency Response parameters Title III.....	93
	Annex 9 – Potential Alternative form – not formal alternative .....	93
	Annex 10 – Code Administrator Consultation responses.....	93



Any questions?

**Code Administrator:**  
Chrissie Brown



Christine.Brown1@nationalgrid.com



telephone: 01926 65  
3328

**Proposer:**

Rob Wilson, National Grid



Richard.Woodward@nationalgrid.com



07799 656402

## Timetable

### Timetable following Code Administrator Consultation:

Grid Code Review Panel Recommendation Vote	8 February 2018
Final Modification Report issued the Authority	20 February 2018
Decision implemented in the Grid and Distribution Codes	Ahead of 18 May 2018

## About this document

This document is the Final Grid Code Modification Report. It contains the views of Panel and contains the responses received from the Code Administrator Consultation which closed on 2 February 2018. This modification was raised in May 2017. The Panel considered the Proposer's recommendation and agreed that this modification required a Workgroup and to be submitted to the Authority for decision.

## Document Control

Version	Date	Author	Change Reference
0.1	11 July 2017	National Grid	Draft Workgroup Consultation
0.2	11 September 2017	Workgroup	Workgroup Consultation issued to Industry
0.3	18 December 2017	Workgroup	Draft Workgroup Report
0.4	22 December 2017	Workgroup	Final Workgroup Report to Panel
1.0	12 January 2018	Code Administrator	Code Administration Consultation Report
2.0	6 February 2018	Code Administrator	Draft Final Modification Report
3.0	20 February 2018	Code Administrator	Final Modification Report to Authority

## 1 Summary

- 1.1 This report outlines the initial Proposal, the Proposer's Solution, Alternative Solutions and corresponding Workgroup Discussions. There is also additional material for justification and to aid understanding.

- 1.2 GC0101 was proposed by National Grid and was submitted to the Grid Code Review Panel for their consideration on 30 May 2017 and the Distribution Code Review Panel on 8 June 2017.
- 1.3 The Grid Code Review Panel decided to send the Proposal to a Workgroup to be developed and assessed against the Grid Code Applicable Objectives.
- 1.4 Section 2 (Original Proposal) and Section 3 (Proposer's solution) are sourced directly from the Proposer and any statements or assertions have not been altered or substantiated/supported or refuted by the Workgroup. Section 4 of the Workgroup contains the discussion by the Workgroup on the Proposal and the potential solution.
- 1.5 The Grid Code Review Panel detailed in the Terms of Reference the scope of work for the GC0101 Workgroup and the specific areas that the Workgroup should consider.
- 1.6 The table at page 37 outlines the EU RfG Articles and proposed Original solution.
- 1.7 **Please note** that following the Workgroup Consultation for GC0100, GC0101 and GC0102 any discussions and amendments to the Distribution Code documents will be covered in the GC0102 Workgroup Report.

### **Workgroup Conclusion**

- 1.8 The Workgroup met on the 6 December 2017 and voted. Fifteen of the sixteen Workgroup members eligible to vote stated that the Original proposal better facilitated the Grid Code objectives. One Workgroup member stated that they would not be casting a vote on the best option.
- 1.9 The Workgroup are satisfied that they have fulfilled their Terms of Reference. A compliance matrix is also attached (Annex 10) to aid navigation of the legal text for the Authority, Grid Code Panel and Industry members.

### **National Grid view**

- 1.10 National Grid as the GB SO supports the original proposal to which no alternative was progressed by the workgroup. Note that the choice of fault ride through parameters (specifically the post-fault retained voltage) led to the need to demarcate between smaller reciprocating engine driven plant and larger gas turbines to avoid compromising a class of generator while also maintaining operational support, and hence to the need for a B/C threshold of 10MW as proposed in GC0100.

### **Code Administrator Consultation Responses**

Eleven responses were received to the Code Administrator Consultation. A summary of the responses can be found in Section 9 of this document. Ten of the eleven respondents agreed that the proposal better facilitates the Grid Code objectives.

### **Grid Code Panel View**

At the Special Grid Code Panel meeting on 8 February 2018, the Panel voted on GC0101 against the Grid Code Objectives.

The Panel members unanimously agreed that the Original was better than the baseline and recommended that it should be implemented.

This Final Modification Report has been prepared in accordance with the terms of the Grid Code. An electronic version of this document and all other GC0101 related documentation can be found on the National Grid website via the following link:

<https://www.nationalgrid.com/uk/electricity/codes/grid-code/modifications/eu-connection-codes-gb-implementation-mod-2>

## **2 Original Proposal**

***Section 2 (Original Proposal) is sourced directly from the Proposer and any statements or assertions have not been altered or substantiated/supported or refuted by the Workgroup. Section 4 of the Workgroup Report contains the discussion by the Workgroup on the Proposal and the potential Solution.***

### **Why**

- 2.1 Guidance from BEIS and Ofgem was to apply the new EU requirements within the existing GB regulatory frameworks. This would provide accessibility and familiarity to GB parties, as well as putting in place a robust governance route to apply the new requirements in a transparent and proportionate way.
- 2.2 This modification needs to be undertaken in timely manner to ensure impacted users are aware of their design requirements, compliance obligations - particularly in relation to procurement of equipment, testing and operational requirements. This modification is also therefore, critical to facilitate/demonstrate member state compliance to these three EU network codes.
- 2.7 This proposal is one of a number of proposals which seek to implement relevant provisions of a number of new EU Network Codes/Guidelines which have been introduced in order to enable

progress towards a competitive and efficient internal market in electricity.

2.8 Some EU Network Guidelines are still in development and these may in due course require a review of solutions developed for Codes that come into force beforehand. The full set of EU network guidelines are:

- Regulation 2015/1222 – Capacity Allocation and Congestion Management (CACM) which entered into force 14 August 2015
- Regulation 2016/1719 – Forward Capacity Allocation (FCA) which entered into force 17 October 2016
- **Regulation 2016/631 - Requirements for Generators (RfG) which entered into force 17 May 2016**
- Regulation 2016/1388 - Demand Connection Code (DCC) which entered into force 7 September 2016
- **Regulation 2016/1447 - High Voltage Direct Current (HVDC) which entered into force 28 September 2016**
- Regulation 2017/1485 – Electricity Transmission System Operation Guideline (TSOG) which entered into force 14 September 2017
- Regulation 2017/2196 – Electricity Emergency and Restoration (E&R) Guideline which entered into force 4 December 2017

2.9 RfG, DCC and HVDC were drafted to facilitate greater connection of renewable generation; improve security of supply; and enhance competition to reduce costs for end consumers, across EU member states. These three codes specifically set harmonised technical standards for the connection of new equipment for generators, demand, and HVDC systems (including DC-Connected Power Park Modules respectively).

2.10 Significant work to progress GB understanding of the codes and consider the approach for implementation has been undertaken in Grid Code/Distribution Code issue groups **GC0048 (RfG)**, **GC0087 (RfG Frequency)** and **GC0090 (HVDC)**.

2.11 These have been widely attended, including DNOs and smaller parties. Additional stakeholder holder engagement has been undertaken to ensure the impacts of the three EU codes is understood, as well as to provide an opportunity to feed into the approach.

2.12 Through proposing these modifications under Open Governance, we will finalise our proposals; and undertake a final industry consultation to confirm they are appropriate, before submitting papers to Ofgem to request a decision

**What**

- 2.9 Full sections of the Grid Code, for example the Connection Conditions (CCs), and the Distribution Code and its daughter documents, will need to be extended to set out the new EU requirements to which impacted users will need to comply with. This will be a combination of completely new requirements inserted into the Grid and Distribution Codes, or adjustments/continuation of corresponding existing GB requirements to line up with equivalents in the new EU codes.
- 2.10 Proposed amendments to the Distribution Code and its associated Engineering Recommendations that implement the above requirements for users connected to distribution systems are also fully considered.

### *How*

- 2.11 With the support of the industry, we will use this modification to finalise proposals to apply the EU Connection Codes requirements, before consulting with the wider industry and submitting to Ofgem for a decision. Previously, Grid Code and Distribution Code issue groups were formed in respect of GC0048 and Grid Code issue groups in respect of GC0087, GC0090 to:
1. Comprehensively review the code to form a local interpretation of the requirements;
  2. Undertake a mapping between the EU and GB codes to understand the extent for possible code changes;
  3. Form proposals, which will now be taken forward as formal modifications.

## 3. Solution

Section 3 (Solution) is sourced directly from the Proposer and any statements or assertions have not been altered or substantiated/supported or refuted by the Workgroup. Section 4 of the Workgroup Report contains the discussion by the Workgroup on the Proposal and the potential Solution.

The proposer's solution is based on work on RfG frequency requirements developed originally in workgroup GC0087, RfG Voltage and Reactive work developed in GC0048 and finally HVDC frequency, Voltage and Reactive requirements which have been carried out in GC0101. Given that both GC0048 and GC0087 developed full detailed requirements and produced consultation reports detailing the reasoning behind the choices full details are not included in this section. The detailed reports for RfG requirements are in references 1 and 2 and a short summary of the requirements are given in sections 3.3 & 3.4, with the majority of section 3 giving full details of the setting of the HVDC requirements which are not detailed elsewhere.

### **3.1. Setting the Voltage & Reactive requirements in GB, as required by the HVDC**

#### **3.1.1. Reactive Capability and Voltage Control in respect of HVDC Converters**

##### **3.1.1.1. HVDC Connections (Title II) - Reactive Power Capability**

The requirements for Reactive Power Capability are defined in Article 20 and Annex IV of the HVDC Code. In summary the principles and concepts for Reactive Power Capability for HVDC Connections are similar to those for Power Park Modules outlined in Article 21 of RfG which defines reactive capability in terms of voltage against Q/Pmax. The principles and interpretation of these requirements are well articulated in the GC0048 Consultation document that can be found at the following link:

<https://www.nationalgrid.com/uk/electricity/codes/grid-code/modifications/gc0048-joint-gcrp-dcrp-workgroup-gb-application-rfg>

(GC0048 Voltage / Reactive Consultation).

Under the HVDC Code and RfG, the reactive capability is defined in terms of a Q/Pmax range rather than the current GB convention of Power Factor. The use of Q/Pmax does have the advantage that its value remains the same irrespective of the MW loading of the Generator or HVDC System unlike Power Factor which will vary as the MW loading starts to drop below its maximum.



To convert between Power Factor and Q/Pmax the following derivation is shown.

$$S = \sqrt{3}VI$$

$$Q = \sqrt{3}VISin\phi$$

$$P = \sqrt{3}VICos\phi \text{ where the Power Factor is defined as } Cos\phi$$

$$\frac{Q}{P} = \frac{\sqrt{3}VISin\phi}{\sqrt{3}VICos\phi} = Tan\phi = Tan(arccos\phi) = Tan(arcos(\text{Power Factor}))$$

$$Q/P_{max} = Tan(arccos(\text{Power Factor}))$$

or

$$\text{Power Factor} = Cos[Arctan(Q/P_{max})]$$

The HVDC defines a maximum operating envelope which each synchronous area must limit its proposed operating limits within. The maximum operating limit is shown in Figure 3.1 and defined in Table 3.1 below.

ANNEX IV

Requirements for U-Q/Pmax-profile referred to in Article 20

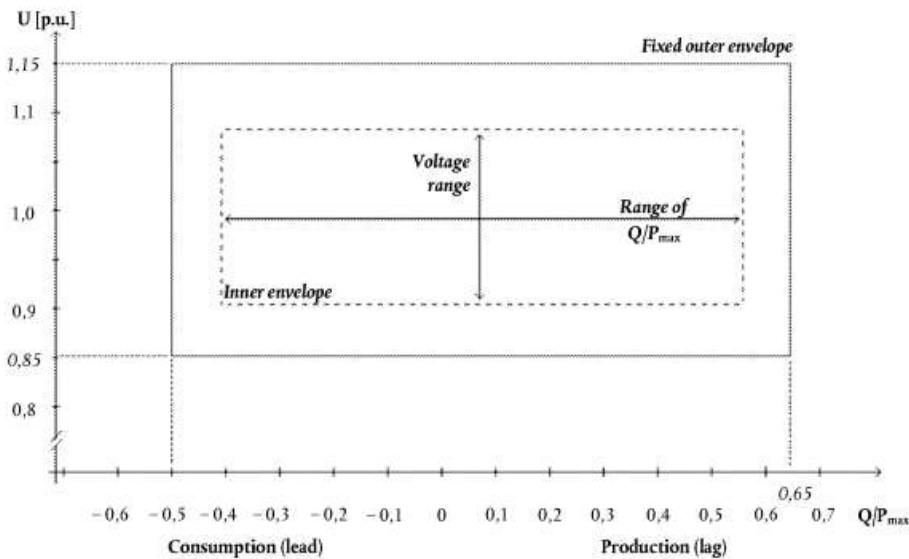

**Figure 5:** The diagram represents boundaries of a U-Q/Pmax-profile with U being the voltage at the connection points expressed by the ratio of its actual value to its reference 1 pu value in per unit, and Q/Pmax the ratio of the reactive power to the maximum HVDC active power transmission capacity. The position, size and shape of the inner envelope are indicative and shapes other than rectangular may be used within the inner envelope. For profile shapes other than rectangular, the voltage range represents the highest and lowest voltage points in this shape. Such a profile would not give rise to the full reactive power range being available across the range of steady-state voltages.

Figure 3.1 – Replication of Figure 5 of Annex IV of the HVDC Code

Synchronous Area	Maximum range of Q/Pmax	Maximum range of steady-state Voltage level in PU
Continental Europe	0,95	0,225
Nordic	0,95	0,15
Great Britain	0,95	0,225
Ireland and Northern Ireland	1,08	0,218
Baltic States	1,0	0,220

**Table 6:** Parameters for the Inner Envelope in the Figure.

**Table 3.1 – Replication of Table 6 of Annex IV**

In summary there is no real difference between the Reactive Power Capability for HVDC Connections in Article 20 and Annex IV of the HVDC Code when compared to Article 21 of RfG in respect of Power Park Modules other than the maximum Q/Pmax range available to TSO's in the HVDC Code is 0.95 whereas in the case of Power Park Modules the maximum Q/Pmax range is set to 0.66. The voltage range of 0.225 remains unchanged between both requirements. As the technology between HVDC Converters and Power Park Modules is similar, it is considered appropriate that the same values proposed for Power Park Modules are adopted for HVDC Connections which is the lesser of the two requirements. This characteristic is shown in Figure 3.2 below.

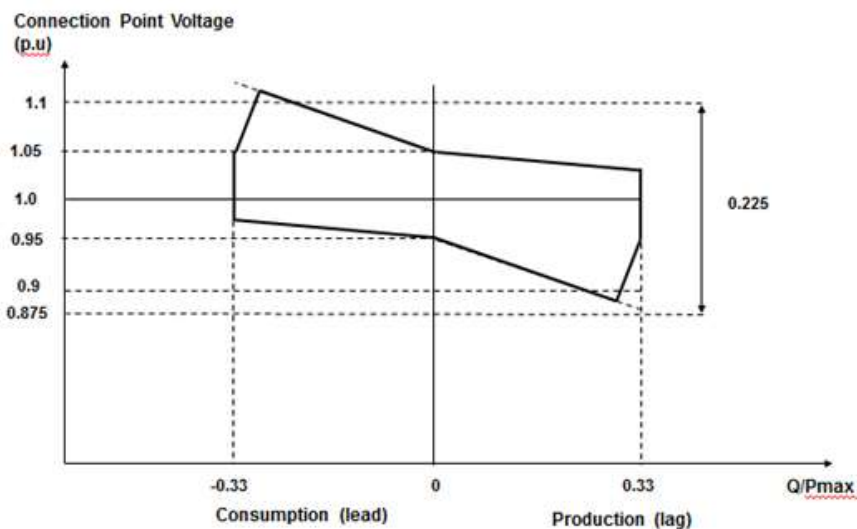

**Figure 3.2 Proposed – U-Q/Pmax Profile for an HVDC Connection caught by the requirements of Title II of the HVDC Code.**

For operation below Maximum Capacity the requirements of Article 20(4) of the HVDC Code would apply which again is similar to that of Article 21(3)(c)(iii) of the RfG. It is therefore proposed to adopt the same requirement as the GB proposal for a Type C and D Power Park Modules. This is shown in Figure 3.3 below.

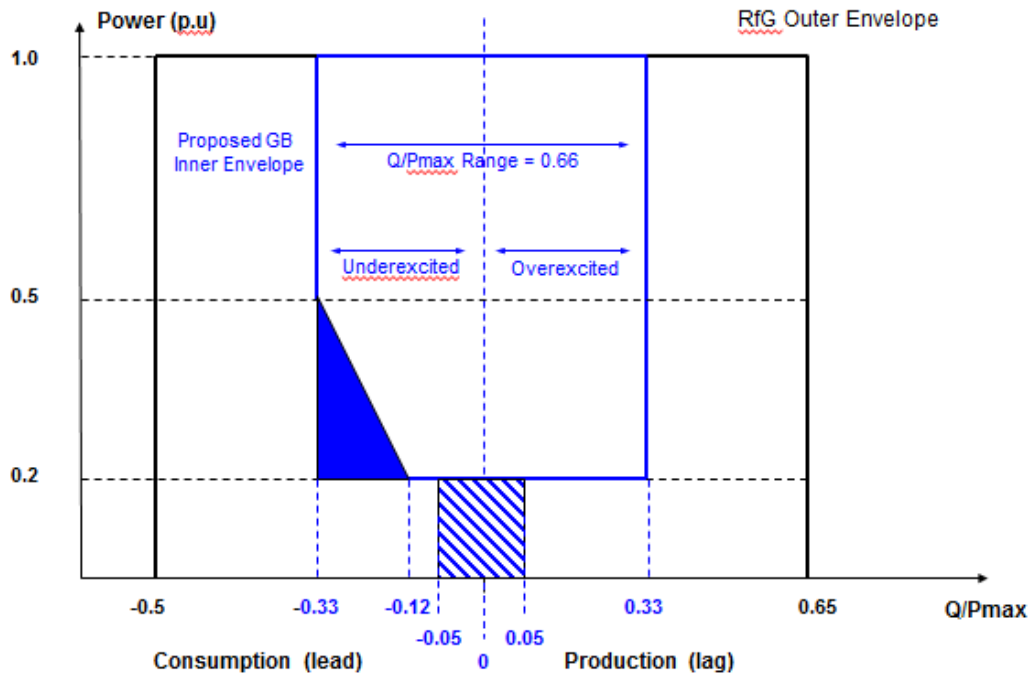

Figure 3.3 – Reactive Capability requirement for a HVDC Connection when operating below maximum output.

Article 21 of the HVDC Codes requires that the reactive power exchanged with the network at the connection point is limited to values specified by the Relevant System Operator in co-ordination with the relevant TSO and the reactive power variation caused by the reactive power control mode operation of the HVDC Converter Station shall not result in a voltage step exceeding the allowed value at the connection point.

The limits on these values and the maximum tolerable voltage step shall be agreed with the Relevant System Operator and the TSO. So far as the GB drafting is concerned, HVDC Converters would have to satisfy the requirements of CC.6.1.7 which relates to permissible voltage fluctuations at the Connection Point.

### 3.1.1.2. Voltage Control

Under Article 22 HVDC Converters (Title II) are required to be capable of operating in Voltage, Reactive Power or Power Factor control mode. For GB implementation voltage control mode will be required. There is very little difference in the performance requirements stipulated for HVDC converters and Power Park Modules under RfG except for the range of selectable values for parameter t1, which sets the time limit for which 90% of the change in reactive power has to occur, is set between 0.1 – 10 seconds and the value for parameter t2 is set between 1 – 60 seconds. In the case of RfG, the range of values for parameter t1 is set to between 1 – 5 seconds and t2 is set between 5 – 60 seconds. As part of this GB Implementation it is proposed to set the requirements of HVDC Connections (Title II) to the same as Type C and D Power Park Modules which are t1 = 1 second and t2 = 5 seconds.

### **3.1.1.3. Reactive Power Control and Power Factor Control**

These control modes of operation will normally be switched off but provisions will be made in the legal drafting to accommodate them if they are required for system reasons. For reactive power control mode and power factor control modes of operation the tolerance required in achieving target set point values is left to the discretion of the relevant System Operator.

On the GB Transmission System the preferred reactive control mode is voltage control. This has the advantage of controlling voltage at defined points across the network which is vital to enable the efficient transfer of real power. That said, the proposed solution for reactive control from generation is voltage control so there is no benefit to having voltage control provided by Generators and an alternative (eg Power Factor Control or Reactive Power Control) from HVDC Converter Technology.

In this case it is suggested that the same approach as RfG (Article 21(3)(d) of the RfG Code) for Type C and D Power Park Modules is adopted for HVDC Connections (Article 2 of the HVDC Code).

### **3.1.2. Reactive Capability and Voltage Control in respect of DC Connected Power Park Modules (Title III)**

Article 38 of the HVDC Code states “The requirements applicable to offshore power park modules under Articles 13 to 22 of Regulation (EU) 2016/631 shall apply to DC-connected power park modules subject to specific requirements provided for in Articles 41 to 45 of this Regulation. These requirements shall apply at the HVDC interface points of the DC-connected power park module and the HVDC systems. The categorisation in Article 5 of Regulation (EU) 2016/631 shall apply to DC-connected power park modules”.

Regulation (EU) 2016/631 is the RfG Code, so in summary this statement means that DC Connected Power Park Modules are required to comply with the requirements of Articles 13 to 22 of RfG as applicable to Offshore Power Park Modules unless these are superseded by any additional requirements covered in Articles 41 to 45. It is however surprising that this text makes no reference to Articles 39 and 40 which is believed to be in error and will need to be confirmed with ENTSO-E.

#### **3.1.2.1. Reactive Power Capability**

The requirements for Reactive Power Capability for DC Connected Power Park Modules are defined in Article 40(2) and Table 11 of Annex VII of the HVDC Code.

The maximum permitted selection of operating limits allowed by the HVDC Code for DC connected PPM is shown in Figure 3.4 and defined in Table 3.2 below.

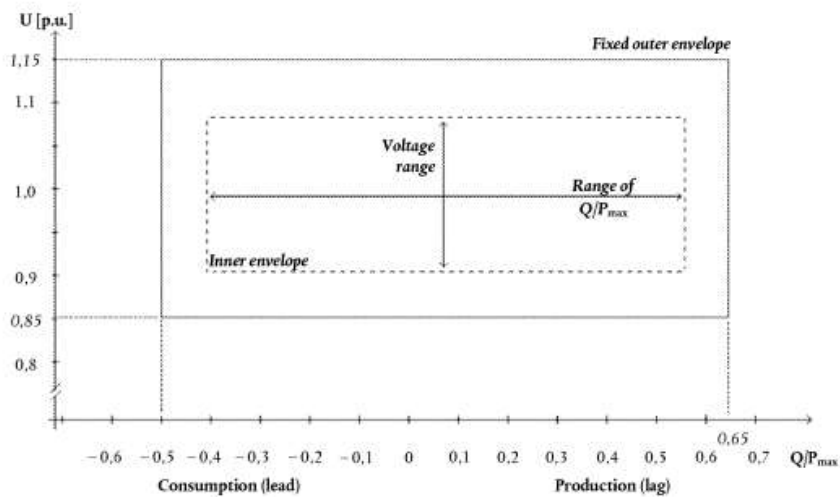

**Figure 7:** U-Q/Pmax-profile of a DC-connected power park module at the connection point. The diagram represents boundaries of a U-Q/Pmax-profile of the voltage at the connection point[s], expressed by the ratio of its actual value to its reference 1 pu value in per unit, against the ratio of the reactive power (Q) to the maximum capacity (Pmax). The position, size and shape of the inner envelope are indicative and other than rectangular may be used within the inner envelope. For profile shapes other than rectangular, the voltage range represents the highest and lowest voltage points. Such a profile would not give rise to the full reactive power range being available across the range of steady-state voltages.

Figure 3.4 Replication of Figure 7 of Annex VII of the HVDC Code

Range of width of Q/Pmax profile	Range of steady-state Voltage level in pu
0-0,95	0,1-0,225

**Table 11:** Maximum and minimum range of both Q/Pmax and steady-state voltage for a DC-connected PPM

Table 3.2 replicates Table 11 of Annex VII

Article 40(2)(a) does include statements as to how the DC Connected Power Park Module shall achieve compliance when the DC Connected Power Park Modules are connected to one or more connection points.

For DC Connected Power Park Modules this is a tricky issue and the amount of reactive support required at the offshore connection point will be a function of the connection topology and size of the AC collector network. It also needs to be noted that due to the presence of the HVDC System between the remote converter end and Onshore end of the DC link there is no real benefit to the onshore system of a wide reactive range.

For DC Connected Power Park Modules, the principles for reactive capability are the same as those for Onshore HVDC Connections (Title II) and Power Park Modules under RfG.

In view of the complexities of this issue and noting the requirements of Article 38 of the HVDC Code it is proposed that the same approach be adopted as that for Configuration 1 and Configuration 2 AC connected Offshore Power Park Modules.

For a radially connected DC Connected Power Park Module (i.e. equivalent to a Configuration 1 AC Connected Power Park Module as defined in RfG) this would require either (i) zero transfer of Reactive Power at the Grid Entry Point over a voltage range of 0.225pu of nominal or (ii) a reactive capability (with an associated steady state tolerance) which shall be in accordance with the U-Q/Pmax profile shown in Figure 5.5 below with the reactive capability and voltage range being agreed between the GB System Operator, the Generator and Offshore Transmission Licensee. Where such an alternative is agreed the value of the voltage range shall be no more than 0.225pu and the maximum Q/Pmax profile range shall be no more than 0 – 0.95.

The minimum requirement is to maintain zero transfer of reactive power at the Connection Point unless alternative values have been specified in which case the U-Q/Pmax profile shown in Figure 3.5 has to be met. For the reader it is worth noting that where a wider reactive range is specified then the requirements of the HVDC Code (Article 40(b)(i)) apply which places requirements on the TSO to specify the U-Q/Pmax profile required.

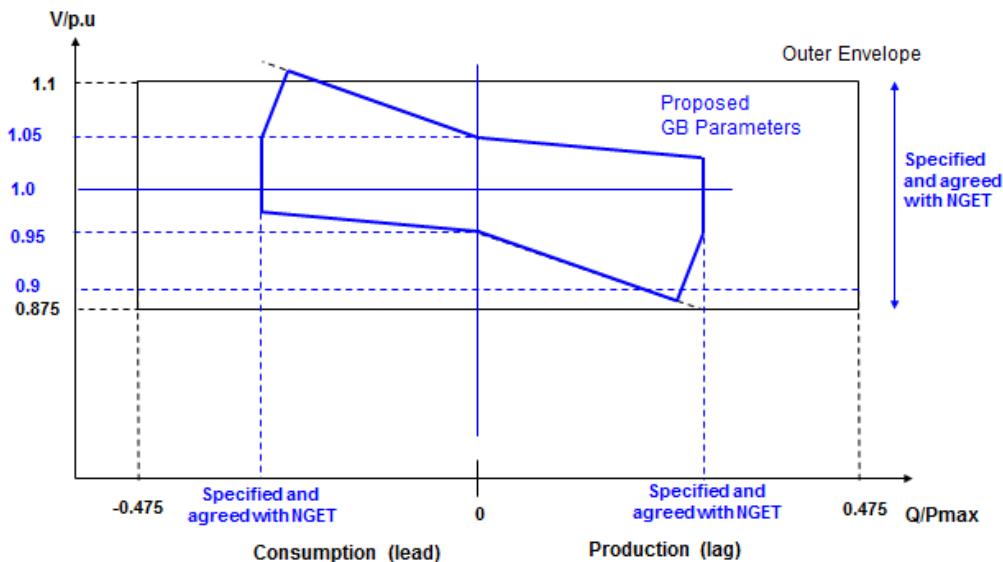

Figure 3.5 U-Q/Pmax profile with the values of Qmax and Qmin and Voltage range being specified in the Bilateral Agreement.

For a meshed connected DC Connected Power Park Module (i.e. equivalent to an AC connected Configuration 2 Power Park Module as defined in RfG) this would require either (i) the minimum reactive capability requirement applicable to an AC Connected Configuration 2

Power Park Module as defined in RfG at the Connection Point or (ii) a reactive capability (with an associated steady state tolerance) which shall be in accordance with the U-Q/Pmax profile shown in Figure 3.6 below with the reactive capability and voltage range being agreed between the GB System Operator, the Generator and Offshore Transmission Licensee. Where such an alternative is agreed the value of the voltage range shall be no more than 0.225pu and the maximum Q/Pmax profile range shall be no more than 0 – 0.95.

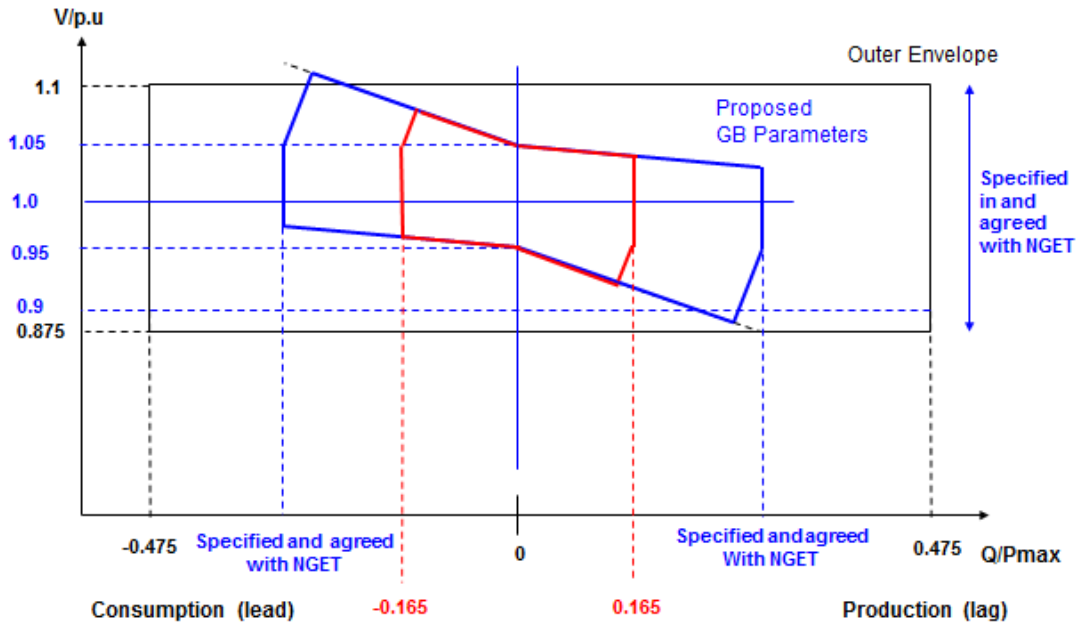

Figure 3.6 U-Q/Pmax profile with the values of Qmax and Qmin and Voltage range being specified and agreed with NGET. The minimum requirement is the red curve unless alternative values have been specified and agreed with NGET in which case the U-Q/Pmax profile shown in Figure 3.6 has to be met. The maximum permitted range of Q/Pmax is 0 – 0.95 and the maximum steady state voltage range is 0.1 – 0.225pu

### 3.1.2.2. Voltage Control, Reactive Power Control and Power Factor Control

Articles 39 – 45 of the HVDC Code do not specify any specific requirements in relation to voltage control, reactive power control or power factor control in respect of DC Connected Power Park Modules. It is, therefore concluded that the requirements of RfG (as stipulated under Article 38 of the HVDC Code which states that DC Connected Power Park Modules should satisfy the requirements of RfG as applicable to Offshore Power Park Modules) should apply and the proposal is therefore to adopt the GB proposal for RfG Type C and D Power Park Modules.

### **3.1.3. Reactive Capability and Voltage Control in respect of Remote End HVDC Converters (Title III)**

#### **3.1.3.1. Reactive Power Capability**

Article 46 of the HVDC Network Code states that the requirements of Article 11 to Article 39 apply to remote end HVDC Converter Stations subject to the specific requirements provided for in Article 47 to 50.

In other words the requirements applicable to remote end HVDC Converter Stations are the same as those in Title II unless an alternative requirement has been specified in Articles 47 to 50 of the HVDC Network Code. It is surprising that Article 46 of the HVDC Network Code includes Article 38 and 39 which applies to DC Connected Power Park Modules and includes requirements from the RfG Network Code. This would infer that Remote End HVDC Converter Stations have to meet a large proportion of the RfG requirements. It is expected that this is an error which needs to be checked with the European Commission.

The requirements for Reactive Power Capability are defined in Article 48(2) and Annex VIII of the HVDC Code. In summary, the HVDC Code requirements follow the same requirements including as those applied for HVDC Connections (Title II) with the maximum Q/Pmax range being set at 0.95 and the maximum range of steady state voltage being 0.225pu. It is therefore proposed to adopt the values suggested for HVDC Connections under Title II which as mentioned above aligns with the RfG requirements for Power Park Modules.

#### **3.1.3.2. Voltage Control, Reactive Power Control and Power Factor Control**

Articles 46 – 50 of the HVDC Code do not specify any specific requirements in relation to voltage control, reactive power control or power factor control in respect of DC Connected Power Park Modules. It is, therefore assumed that the requirements of HVDC Connections (as stipulated under Article 46) apply and the proposal is to adopt the same approach as that for HVDC Connections.

### **3.2. Setting the Frequency requirements in GB, as required by the HVDC**

For RfG, the Frequency issues were discussed as part of the GC0087 Consultation. Annexes 8, 9 and 11 of this report summarise the key frequency related parameters selected with reasons. The overall reasoning as to why these values were selected is covered in detail the GC0087 Consultation (Reference [2]).

As part of the GC0087 consultation, a number of responses were received. A response to these comments is provided in Annex 7 and the legal text has been updated as appropriate.



One specific point raised as part of the GC0087 consultation was that under RfG, the droop for Synchronous Power Generating Modules may be specified differently to that for Power Park Modules. This issue was discussed as part of the GC0087 work group and the simplest method is to make the value of Pref (as defined in RfG) the same as the maximum capacity for both Synchronous Power Generating Modules and Power Park Modules. For a Power Park Module this performance requirement would be reduced for the amount of turbines in service which follows current GB practice. The draft legal text has been updated to reflect this change. For operation in LFSM-O Mode it would also mean that the Power Output should start to drop off above 50.4Hz irrespective of the loading point of the Power Generating Module.

So far as HVDC is concerned, the proposal is to adopt the same frequency parameters as those recommended for RfG unless there is good reason not to do so for example where the HVDC Code specifies a different range or value.

HVDC is however complex in so far that it covers three elements – namely HVDC Connections (such as an Interconnector), DC Connected Power Park Modules (i.e. a Power Park Module connected behind an HVDC System) and requirements on Remote End DC Converters. In summary, several of the requirements (in particular frequency ranges) are more onerous than those in RfG. As part of this Workgroup report, a set of tables have been included in the Annex’s which applies to Type A, B and C which provides a high level starting point of the suggested frequency parameter settings. Some of these values are mandated by the HVDC Code whilst others are subject to National choice.

### 3.2.1. HVDC Connections Title II

In terms of the frequency parameters there are a few issues worthy of special mention and these are summarised in the table below.

Frequency Range (Hz)	Setting	Comment
47 – 47.5Hz	60 seconds	Mandated under HVDC Code more onerous than current GB requirement of 20 seconds
47.5 – 49 Hz	Specified by TSO but longer than RfG. The RfG GB proposal is 90 minutes	Any value can be selected greater than 90 minutes. There is no materiality to National Grid of increasing this value..
49 – 51 Hz	Unlimited	As per RfG
51 – 51.5Hz	Specified by TSO but longer than RfG. The RfG GB proposal is 90 minutes	Any value can be selected greater than 90 minutes. There is no materiality to National Grid of increasing this value.

51.5Hz – 52Hz	To be specified by each TSO but longer than DC Connected Power Park Modules as specified under Article 39 which is 15 minutes. The RfG GB proposal is 15 minutes.	Any value can be selected greater than 15 minutes. There is no materiality to National Grid of increasing this value. .
Rate of change of System Frequency	$\pm 2.5\text{Hz/s}$ measured over 1 second	Mandatory requirement under HVDC Code

The other frequency parameters are also covered in the annexes of this report but they are not believed to be so onerous.

### **3.2.2. DC Connected Power Park Modules Title III**

In terms of the proposed frequency parameters and settings, these are summarised in Annex 11 of this report. In summary there are no fundamental differences here in the frequency settings between DC Connected Power Park Modules and those in RfG. The only notable exception is the Rate of Change of Frequency which is set at  $\pm 2\text{Hz/s}$  measured over a 1 second time period. This is a mandatory parameter which has been set by the HVDC Code.

### **3.2.3. Remote End HVDC Converter Stations (Title III)**

For Remote End HVDC Converter Stations the proposed frequency parameters and settings are summarised in Annex 8 of this report. In summary they are the same as those for HVDC Connections under Title II.

## **3.3. Setting the Voltage and Reactive requirements in GB, as required by the RfG**

The GC0048 RfG Voltage/Reactive Consultation was published on 27 December 2016 and can be found in reference 1; 12 responses were received, which are summarised in Annex 2 together with National Grid's response. This report and legal text has been updated to reflect these comments where it is felt appropriate to do so.

## **3.4. Setting the Frequency requirements in GB, as required by the RfG**

This consultation was published on 20 April 2017 and can be found in reference 2; 4 responses were received, which are summarised in Annex 7 together with National Grid's response. This report and legal text has been updated to reflect these comments where it is felt appropriate to do so. The following tables summarise the frequency requirements from the report.



**Setting of the Frequency requirements in GB, as required in RfG – for generators with capacity of Type A and greater;**

RfG Article	Requirement	Range		Suggested GB Value		Interactions	Policy Req'd? (e.g. Non-compatibility to be defined)	Code Change req'd?
13.1(a)	Frequency Ranges	47 – 47.5Hz	20 seconds	47 – 47.5Hz	20 seconds	DCC;	No	No
		47.5 – 48.5Hz	90 minutes	47.5 – 49.0Hz	90 minutes	RfG Voltage & Reactive		
		48.5 – 49.0Hz	TSO defined (not less than 90mins)	49.0 – 51Hz	Continuous			
		49.0 – 51.0Hz	Unlimited					
		51.0 – 51.5Hz	90 minutes	51.0 – 51.5Hz	90 minutes			
		51.5 – 52Hz	15 minutes	51.5 – 52Hz	15 minutes			
13.2	LFSM-O	Frequency threshold	50.2 – 50.5Hz	Frequency threshold	50.4Hz	HVDC; DCC	To define activation time in GC	?
		Droop	2 – 12%	Droop	10% (2%/0.1Hz)			
		Activation delay	<2 s	Activation delay	<2s			
- 13.2(f)		DMOL						Y
13.3	Maintenance of Constant Active Power	49.5 – 50.5 Hz? – By interpretation		49.5 – 50.4Hz				Y
13.4-13.5	Power Output with Falling Frequency	Below 49Hz falling by a reduction rate of 2% of the Max Capacity at 50Hz/1Hz Freq. drop; Below 49.5Hz by a reduction rate of 10% of the Max Capacity at 50Hz per 1Hz Freq drop		Power Output should not drop by more than pro-rata with frequency (i.e. max permitted requirement is 100% power at 49.5Hz falling linearly to 95% at 47.0Hz)				Y

**Settings of the Frequency Requirements in GB, as required in the RfG – for generators with capacity of Type C and greater**

Article	Requirement	Range		Suggested GB Value		Interactions	Policy Req'd? (e.g. non-compatibility to be defined)?	Code Change Req'd?					
15.2(c)	LFSM-U	Frequency Threshold	49.8–	Frequency Threshold	49.5Hz		Y	Y					
		Droop	2 – 12%	Droop	10%								
		Initial Delay	<2s	Initial Delay	<2s								
15.2(d)	FSM	Active Power range	1.5 – 10%	Active Power range $\Delta P_{1i}/P_{max}$	10%		Y	Y					
		Frequency Insensitivity	10 – 30mHz	Frequency Insensitivity $\Delta f_{fi}$	$\pm 15$ mHz								
		Frequency Insensitivity	0.02–0.06%	Frequency Insensitivity $\Delta f_{fi} / f_n$	$\pm 0.03$ %								
		Deadband	0-500mHz	Deadband	0								
		Droop	2 – 12%	Droop	3 – 5%								
		Maximum admissible initial delay t1 for Generation with Inertia	2s	Maximum admissible initial delay t1 for Generation with Inertia	2s								
		Maximum admissible initial delay t1 for Generation without Inertia		TSO defined					Maximum initial admissible delay t1 for Generation without Inertia	1s			
		Full activation time t2	30s		Full activation time t2				10s				
		15.2(g)	ASBMON	Status Signal (on/off)					Status Signal (on/off)			Y	Y
				Scheduled Active Power output					Scheduled Active Power output				
Actual value of Active Power output				Actual value of Active Power output									
Actual parameter settings for Active Power				Actual parameter settings for Active Power									
Frequency Response				Power Frequency Response									
Droop and deadband				Droop and deadband									
13.1(b)	RoCoF withstand	To be defined by the TSO		$\pm 1$ Hzs <sup>-1</sup>		DCC	Y	Y					

## Workgroup Consultation overview

The Workgroup Consultation was issued on the 11 September 2017 and closed on the 2 October 2017. Thirteen responses were received. The full responses can be found in Annex 6.

Response From	Q1: Do you believe that GC0101 Original proposal, or any potential alternatives for change that you wish to suggest, better facilitates the Grid Code Objectives?
<i>Tom Chevalier, Association of Meter Operators</i>	No comment
<i>Marko Grizelj, Siemens</i>	No comment indicated
<i>Alan Creighton, Northern Powergrid</i>	The original proposal better facilitates the Grid Code and Distribution Code objectives. We are not convinced that the potential alternative related to the 'stringency' concern would better facilitate these objectives.
<i>Pthomas, Nordex Acciona Wind Power</i>	Yes
<i>Greg Middleton, AMPS</i>	The original proposal better facilitates the objectives.
<i>DONG,</i>	Yes, I agree that the Original proposal facilitates the RfG national implementation for Voltage + reactive and frequency response provisions.
<i>Isaac Gutierrez, Scottishpower Renewable ltd (UK)</i>	Yes, to some extent but please refer to comment within SPR response to this consultation.
<i>Graeme Vincent, SP</i>	We believe that the proposals outlined in the GC0101 Original Proposal better facilitate the Grid Code Objectives.

Response From	Q1: Do you believe that GC0101 Original proposal, or any potential alternatives for change that you wish to suggest, better facilitates the Grid Code Objectives?
Energy Networks	
Garth Graham, SSE	<p><b>ORIGINAL</b></p> <p>We do not believe that GC0101 does better facilitate the Grid Code Objectives as it <u>fails to</u> discharge the obligations imposed upon the licensee by this license and to comply with the Electricity Regulation and any relevant legally binding decisions of the European Commission and/or the Agency.</p> <p>As the National Grid presentation to EnergyUK on 23<sup>rd</sup> May 2017 noted, in respect of the three connection codes (RfG, DCC and HVDC), the aim of these Network Codes is to “<i>Set consistent technical requirements across EU for new connections of user equipment (e.g. generation / interconnectors)</i>”. This accords with the recitals of the RfG, DCC and HVDC Network Codes.</p> <p>However, as both the Proposer’s explanations to the Workgroup and the legal text makes clear there is not even to be a set of consistent technical requirements across GB (let alone with the EU) for new connections as a result of GC0101 as, for example, apparently many of these multiple technical requirements are, instead, to be determined by the network operate alone, in a non-open / non-transparent way, and applied differently to each new connection. This non-harmonised approach is inconsistent with the EU Network Codes.</p> <p>Furthermore, the imposition of additional costs (such as the twelve items listed on pages 44-45 of the Workgroup consultation document) will affect cross border trade between Member States as well as within the Member State (between GB and Northern Ireland) and as such will not be in compliance with Article 8(7) of Regulation 714/2009.</p> <p>In addition to not being better in terms of Objective (iv) the GC0101 Original does better facilitate the Grid Code Objectives (ii), (iii) and (v) as it:</p> <ul style="list-style-type: none"> <li>fails to facilitate competition in the generation and supply of electricity (by not complying with EU law – see above – and imposing additional costs on GB generation);</li> <li>fails to promote security and efficiency in electricity generation (by not complying with EU law – see above); and</li> </ul>

Response From	Q1: Do you believe that GC0101 Original proposal, or any potential alternatives for change that you wish to suggest, better facilitates the Grid Code Objectives?
	<p>fails to promote efficiency in the implementation and administration of the Grid Code arrangements (by not complying with EU law – see above).</p> <p><b>POTENTIAL ALTERNATIVE (a)</b></p> <p>We do believe that potential alternative (a) does better facilitate the Grid Code Objectives as it ensures the discharging of the obligations imposed upon the licensee by its license and to comply with the Electricity Regulation and any relevant legally binding decisions of the European Commission and/or the Agency.</p> <p>As the National Grid presentation to EnergyUK on 23<sup>rd</sup> May 2017 noted, in respect of the three connection codes (RfG, DCC and HVDC), the aim of these Network Codes is to “<i>Set consistent technical requirements across EU for new connections of user equipment (e.g. generation / interconnectors)</i>”. This accords with the recitals of the RfG, DCC and HVDC Network Codes.</p> <p>It is clear that this potential alternative (a) seeks to ensure that only those obligations applicable to newly connecting parties that fall within the scope of the EU Network Codes will be implemented into the GB national network codes (such as, but not limited to, the Grid Code and Distribution Code) as required by those EU Network Codes.</p> <p>As detailed on pages 40-47 of the Workgroup consultation document there are clear reasons as to why this is required.</p> <p>In addition to being better in terms of Objective (iv) the potential alternative (a) also better facilitate the Grid Code Objectives (ii), (iii) and (v) as it:</p> <ul style="list-style-type: none"> <li>as by complying with EU law – see above – and not imposing additional costs (over and above those required by law) on GB generation it facilitates competition in the generation and supply of electricity;</li> <li>as by complying with EU law – see above – and not imposing additional costs (over and above those required by law) on GB generation it promotes security and efficiency in electricity generation; and</li> <li>as by complying with EU law – see above – and not imposing additional costs (over and above those required by law) on GB generation it promotes efficiency in the implementation and administration of the Grid Code arrangements.</li> </ul>



Response From	Q1: Do you believe that GC0101 Original proposal, or any potential alternatives for change that you wish to suggest, better facilitates the Grid Code Objectives?
Alastair Frew, Scottishpower Generation Ltd	Yes as it implements European Law.
Andy Vaudin, EDF	Yes, we agree that GC0101 Original Proposal facilitates the Grid Code Objectives.
Rob Wilson, NGET	<p>The original proposal for GC0101 better fulfils the Grid Code Objectives.</p> <p>An assessment of the original proposal against the Grid Code objectives is as follows:</p> <ul style="list-style-type: none"> <li data-bbox="331 592 1877 655">i. <i>To permit the development, maintenance and operation of an efficient, coordinated and economical system for the transmission of electricity</i></li> </ul> <p>Positive. In developing this code modification the task of the workgroup has been to find a balance between the costs that will be incurred by owners of equipment in complying with a more onerous specification and the benefit to the system in avoiding operational costs that would otherwise be incurred in providing support due to the connection of less capable equipment. This is also the aim of the European Network Codes as stated by ENTSO-E and is particularly important given the development of the system and the shift in the generation portfolio from larger, centrally despatched units to smaller and embedded renewable generation.</p> <ul style="list-style-type: none"> <li data-bbox="331 932 1937 1034">ii. <i>To facilitate competition in the generation and supply of electricity (and without limiting the foregoing, to facilitate the national electricity transmission system being made available to persons authorised to supply or generate electricity on terms which neither prevent nor restrict competition in the supply or generation of electricity)</i></li> </ul> <p>Positive. Ofgem have made clear during the workgroup proceedings that their decisions will be based on evidence in both directions – ie that where choices are made these are based on a tipping point being reached where the costs of choosing more onerous settings is evidenced to outweigh the operational benefit.</p> <ul style="list-style-type: none"> <li data-bbox="331 1187 1917 1251">iii. <i>Subject to sub-paragraphs (i) and (ii), to promote the security and efficiency of the electricity generation, transmission and distribution systems in the national electricity transmission system operator area taken as a whole</i></li> </ul> <p>Positive, as stated above, in making balanced choices for the overall benefit of the end consumer.</p>

Response From	Q1: Do you believe that GC0101 Original proposal, or any potential alternatives for change that you wish to suggest, better facilitates the Grid Code Objectives?
	<p>iv. <i>To efficiently discharge the obligations imposed upon the licensee by this license and to comply with the Electricity Regulation and any relevant legally binding decisions of the European Commission and/or the Agency; and</i></p> <p>Positive. This modification is required to implement elements of the 3 European Connection Codes forming part of the suite of European Network Codes resulting from the EU 3rd Package legislation (EC 714/2009).</p> <p>v. <i>To promote efficiency in the implementation and administration of the Grid Code arrangements</i></p> <p>Neutral. Although noting that this is the 2<sup>nd</sup> (GC0100 being the first) comprehensive modification to be taken through Grid Code Open Governance and therefore one of the first Grid Code modifications to go through an official workgroup consultation which will be followed on acceptance of the workgroup report by the Grid Code Panel by a Code Administrator consultation.</p> <p>So as noted above, the GC0101 original proposal better facilitates objectives (i)-(iv) and is neutral against objective (v).</p> <p>The ‘more stringent’ alternative fulfils none of the objectives as summarised below.</p> <p>Assessment of the ‘more stringent’ alternative against the Grid Code objectives:</p> <p>i. <i>To permit the development, maintenance and operation of an efficient, coordinated and economical system for the transmission of electricity</i></p> <p>Negative. The ‘more stringent’ alternative does not embody the minimum solution as required by Ofgem for implementation of the European Network Codes and so does not permit efficient development.</p> <p>ii. <i>To facilitate competition in the generation and supply of electricity (and without limiting the foregoing, to facilitate the national electricity transmission system being made available to persons authorised to supply or generate electricity on terms which neither prevent nor restrict competition in the supply or generation of electricity)</i></p> <p>Negative. The ‘more stringent’ alternative is not achievable in the time available and proposes striking out of national code requirements without which system security will be compromised and new connections will be unable to proceed under safety rules and due to a lack of clarity over equipment specifications. Further, due to the time that solving these issues will take the ability of new entrants to meet their European Connection Code obligations will be compromised as</p>

Response From	Q1: Do you believe that GC0101 Original proposal, or any potential alternatives for change that you wish to suggest, better facilitates the Grid Code Objectives?
	<p>the leadtime that they will have prior to compliance being required will be reduced.</p> <p><i>iii. Subject to sub-paragraphs (i) and (ii), to promote the security and efficiency of the electricity generation, transmission and distribution systems in the national electricity transmission system operator area taken as a whole</i></p> <p>Negative. The 'more stringent' alternative will prevent secure connection of new entrants and stifle development of efficient solutions.</p> <p><i>iv. To efficiently discharge the obligations imposed upon the licensee by this license and to comply with the Electricity Regulation and any relevant legally binding decisions of the European Commission and/or the Agency; and</i></p> <p>Negative. The 'more stringent' alternative is not a minimum or efficient solution as required by Ofgem.</p> <p><i>v. To promote efficiency in the implementation and administration of the Grid Code arrangements</i></p> <p>Negative' The 'more stringent' alternative will require comprehensive and unnecessary modifications to the existing national codes.</p>
Senvion	Yes

## 4. Workgroup Discussions

### 4.1. Workgroup

The Workgroup convened seven times to discuss the issue, detail the scope of the proposed defect, devise potential solutions and assess the proposal in terms of the Grid Code Applicable Objectives.

The Proposer presented the defect that they had identified in the GC0101 proposal. The discussions and views of the Workgroup are outlined below.

The majority of the EU requirements captured in GC0101 have been previously consulted on via modifications GC0048 – RfG Voltage /Reactive and GC0087 - RfG Frequency Response. These were issue groups originally set up jointly under the Grid and Distribution Codes to engage with industry around the changes that would be required to the codes as a result of the implementation of the European Network Code (RfG) prior to the Open Governance Arrangements.

This report will address outstanding voltage and frequency requirements which have not yet been consulted on, notably the requirements arising from the HVDC Code. It will also attempt to address any issues raised by stakeholders during the previous consultations mentioned above. A table summarising the responses to the previous consultations and where the Proposer has addressed any concerns raised can be found in Annex 7.

This report includes the full proposed legal text for the EU requirements in question (i.e. GC0101 + GC0048 + GC0087)

In general the approach adopted will be to use the existing GB requirements unless there is a conflict with the RfG or HVDC code.

### 4.2. Definitions

A complex area of this work has been the management of definitions between the defined terms used in the EU Network Codes and those used in the GB national network codes, such as the Grid Code and the Distribution Code.

Article 2 of RfG includes a number of definitions which relate to physical quantities for example, voltage and current. RfG does however define these terms for example

“Voltage” means the difference in electrical potential between two points measured as the root mean square of the positive sequence phase to phase voltages at fundamental frequency”

“Current” means the rate at which electric charge flows which is measured by the root mean square value of the positive sequence of the phase current at fundamental frequency.

These definitions do create a number of issues, largely because there are many different connotations of these physical quantities. For example, in a three phase system the voltage could be the instantaneous phase to neutral voltage, the instantaneous phase to phase voltage, the positive phase sequence RMS voltage, the transient over voltage to name but a few. Similar issues arise with other physical quantities such as current. In these circumstances it was suggested by the Proposer that it was far better if the correct term as defined in IEC standards or equivalent are used.

This issue was discussed amongst the Workgroup on a number of occasions. In general the GB Codes do not define terms such as current or voltage as a result of the different set of circumstances under which they would apply. After advice was sought from the ENTSO-E code drafting team, some Workgroup Members set out that physical quantities or other standard engineering terms did not need to be re-defined to implement the EU Connection Codes, and that the current GB definitions could therefore be used. In the main this approach was accepted by the workgroup membership.

However, one Workgroup member was concerned that substituting GB definitions for those in the EU Network Codes may have unintended consequences, including that it could (i) amount to applying more stringent obligations<sup>1</sup> on ‘new’ connecting parties than required by the EU Network Codes and / or (ii) result in existing connected parties being obligated under the EU Network Codes without either (a) them having modified their facility to such an extent that their connection agreement required to be amended accordingly and / or (b) having not been the subject of a Cost Benefit Analysis undertaken in accordance with the EU Network Codes.

Some Workgroup members noted that whilst ENTSO-E’s views on this topic were interesting, they had no vires to opine on this matter.

### **4.3. Voltage Ranges**

#### **4.3.1. RfG – Voltage Ranges**

RfG Article 16(2)(a) Tables 6.1 and 6.2 define the steady state voltage operating range for Type D Power Generating Modules. CC.6.1.4 of the Grid Code currently defines the steady state operating range of all Users’ connected to the Transmission System.

---

<sup>1</sup> The background associated with ‘more stringent’ obligations is explored later in this section under ‘Potential Alternatives (b) Removing More Stringent Requirements’.

CC.6.1.4 and RfG Article 16(2)(a) Tables 6.1 and 6.2 are similar, other than the GB Code requires the voltage range applicable to User's connected below 132kV should be within  $\pm 6\%$  - RfG requires Type D Power Generating Modules connected between 132kV and 110kV to remain within the limits of  $\pm 10\%$

It is not envisaged that this will have any significant impact on current GB practice as equipment rated at a nominal voltage of between 132kV and 110kV is generally not used.

Therefore, it is proposed that the Voltage Range requirement as defined in Grid Code CC.6.1.4 is maintained (ensuring consistency with the requirements of the ESQCR), accepting that CC.6.1.4 will require minor changes to ensure consistency with the European Codes. However, some Workgroup members were concerned that this would apply a more stringent<sup>2</sup> requirement on newly connecting parties.

#### 4.3.2. HVDC - Voltage Ranges

Under the HVDC Code, the requirements are split into three categories depending the type of equipment. These being HVDC Connections (Title II), DC Connected Power Park Modules (Title III) and Remote End HVDC Converters (Title III). A diagram showing the representation of these different arrangements is shown in Figure 4.1(a) and Figure 4.2(b).

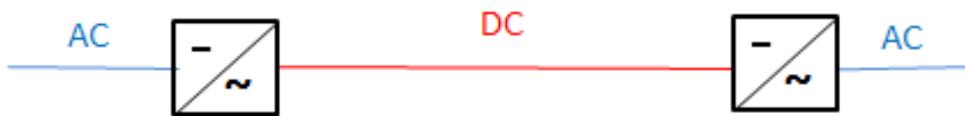

Figure 4.1 (a) – Illustration of a HVDC Connection caught under the requirements of Title II of the HVDC Code.

---

<sup>2</sup> The background associated with 'more stringent' obligations is explored later in this section under 'Potential Alternatives (a) Removing More Stringent Requirements'.

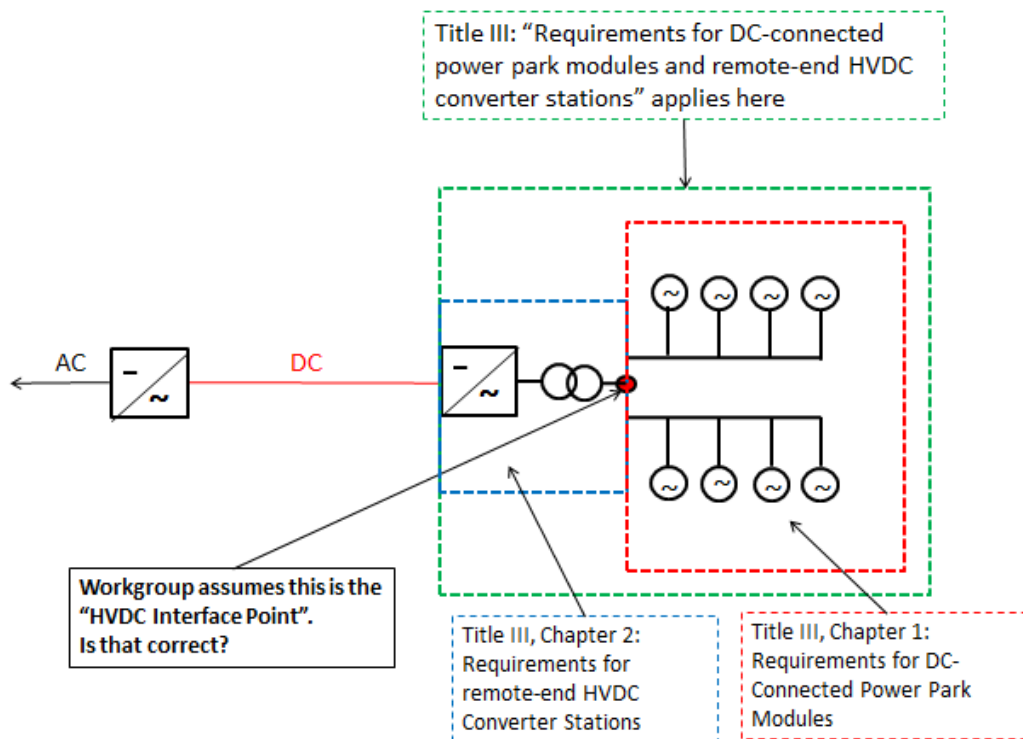

Figure 4.1(b) – Illustration of DC Connected Power Park Modules and Remote End HVDC Converter Stations caught under the requirements of Title III of the HVDC Code in addition to the appropriate definitions used under the HVDC Code.

#### 4.3.2.1. HVDC Connections (Title II)

For HVDC Connections caught under Title II, the Voltage range requirements are defined under Article 18 and Tables 4 and 5 of Annex III of the HVDC Code which are replicated in Annex 9.

For the GB Synchronous Area the voltage ranges for HVDC Connections are the same as RfG and therefore it is suggested to adopt the same values as proposed for RfG.

#### 4.3.2.2. DC Connected Power Park Modules (Title III)

For DC Connected Power Park Modules the voltage ranges are defined in Article 40 and Tables 9 and 10 of Annex VII which are tabulated below in Table 4.1(a) and Table 4.1(b).

Voltage Range (pu)	Time Period for Operation
0.85 – 0.90	60 minutes
0.90 – 1.10	Unlimited
1.10 – 1.118	Unlimited unless otherwise specified by the Relevant System Operator in co-ordination with the relevant TSO (15 minutes proposed)

1.118 – 1.15	To be specified by the relevant System Operator in coordination with the relevant TSO ( <i>15 minutes proposed</i> )
--------------	--

Table 4.1(a) Minimum time periods for which a DC Connected Power Park Module shall be capable of operating for different voltage deviating from reference 1pu value without disconnecting from the network where the voltage base for pu values is from 110kV to (not including) 300kV.

<b>Voltage Range (pu)</b>	<b>Time Period for Operation</b>
0.85 – 0.90	60 minutes
0.90 – 1.10	Unlimited
1.05 – 1.15	To be specified by the Relevant System Operator in co-ordination with the relevant TSO. Various sub-ranges of voltage withstand capability can be specified ( <i>15 minutes proposed</i> )

Table 4.1(b) Minimum time periods for which a DC Connected Power Park Module shall be capable of operating for different voltage deviating from reference 1pu value without disconnecting from the network where the voltage base for pu values is from 300kV to 400kV.

In summary there is little choice for the TSO other than in respect of the voltage range between 1.05 – 1.15pu. To ensure consistency with RfG and acknowledging that the voltage ranges are beyond those of RfG it is suggested that a 15 minute time period is proposed for these values. However, some Workgroup members were concerned that this would apply a more stringent<sup>3</sup> requirement on newly connecting parties.

#### 4.3.2.3. Remote End HVDC Converters (Title III)

For Remote End HVDC Converters the voltage ranges are defined in Article 48 and Tables 12 and 13 of Annex VIII which are tabulated below in Tables 4.2(a) and Table 4.2(b).

<b>Voltage Range (pu)</b>	<b>Time Period for Operation</b>
0.85 – 0.90	60 minutes
0.90 – 1.10	Unlimited
1.10 – 1.12	Unlimited unless otherwise specified by the System Operator in co-ordination with the relevant TSO ( <i>15 minutes proposed</i> )
1.12 – 1.15	To be specified by the relevant System Operator in coordination with the relevant TSO ( <i>15 minutes proposed</i> )

<sup>3</sup> The background associated with ‘more stringent’ obligations is explored later in this section under ‘Potential Alternatives (a) Removing More Stringent Requirements’.



Table 4.2(a) Minimum time periods for which a remote end HVDC Converter Station shall be capable of operating for different voltages deviating from reference 1pu value without disconnecting from the network where the voltage base for pu values is from 110kV to (not including) 300kV.

<b>Voltage Range (pu)</b>	<b>Time Period for Operation</b>
0.85 – 0.90	60 minutes
0.90 – 1.05	Unlimited
1.05 – 1.15	To be specified by the Relevant System Operator in co-ordination with the relevant TSO. Various sub-ranges of voltage withstand capability can be specified ( <i>15 minutes proposed</i> )

Table 4.2(b) Minimum time periods for which a remote end HVDC Converter Station shall be capable of operating for different voltages deviating from reference 1pu value without disconnecting from the network where the voltage base for pu values is from 300kV to 400kV (included).

In summary there is little choice for the TSO other than in respect of the voltage range between 1.05 – 1.15pu. To ensure consistency with RfG and acknowledging that the voltage ranges are beyond those of RfG it is suggested that a 15 minute time period is proposed for these values. However, some Workgroup members were concerned that this would apply a more stringent<sup>4</sup> requirement on newly connecting parties.

### **4.3.3. Specification of Wider Voltage Ranges**

#### **4.3.3.1. RfG**

RfG Article 16 (2)(b) does permit the relevant System Operator in coordination with the Generator and relevant TSO to specify wider voltage ranges or longer minimum operating times if economically and technically feasible.

In addition, Article 16(2)(c) states that the relevant System Operator in coordination with the Relevant TSO shall have the right to specify voltages at the connection point at which a Power Generating Module is capable of disconnection.

#### **4.3.3.2. HVDC**

##### **4.3.3.2.1. HVDC Connections (Title II)**

Article 18 of the HVDC Code does permit the System Operator in co-ordination with the relevant TSO to set wider ranges or longer minimum operating times.

---

<sup>4</sup> The background associated with ‘more stringent’ obligations is explored later in this section under ‘Potential Alternatives (a) Removing More Stringent Requirements’.

In addition, HVDC Converters shall be capable of automatic disconnection at connection point voltages specified by the relevant Network Operator in coordination with the TSO. The terms and settings for automatic disconnection would need to be agreed between the System Operator, TSO and relevant HVDC System Owner.

This flexibility will be included in the legal drafting.

#### **4.3.3.2.2. DC Connected Power Park Modules (Title III)**

Article 40(1)(e) of the HVDC Code does permit wider voltage ranges and longer minimum operating times and conditions for disconnection and the voltage ranges applicable where other technologies are employed and the nominal frequencies are at a value other than 50Hz. In this case such requirements would need to be agreed with National Grid and the Relevant TSO (eg an OFTO) but would need to be in proportion to the values highlighted in Table 4.1 above.

#### **4.3.3.2.3. Remote End HVDC Converters (Title III)**

For remote end HVDC Converters, similar requirements would apply as per DC connected Power Park Modules as outlined in Article 48 (1)(d) of the HVDC Code. Wider voltage ranges or longer minimum operating times may be permitted but these would be agreed with National Grid and the Relevant TSO (eg an OFTO). For plant operating at nominal frequencies other than 50Hz, the time periods specified would be in proportion to those in Tables 4.2(a) and (b) above.

#### **4.3.4. Operational conditions for simultaneous over voltage and underfrequency or simultaneous undervoltage and overfrequency**

##### **4.3.4.1. RfG**

Article 16(2)(a)(ii) permits the Relevant TSO to specify shorter periods of time during which Type D Power Generating Modules shall be capable of remaining connected to the network in the event of simultaneous overvoltage and under-frequency or simultaneous under-voltage and over-frequency.

Both Type C and Type D Power Generating Modules are subject to the same reactive capability, and frequency range capability requirements. It therefore seems appropriate to apply the same voltage ranges (as per current GB practice) to Type A – C power generating modules too. However, some Workgroup members were concerned that this would apply a more stringent<sup>5</sup> requirement on newly connecting parties.

##### **4.3.4.2. HVDC**

---

<sup>5</sup> The background associated with 'more stringent' obligations is explored later in this section under 'Potential Alternatives (a) Removing More Stringent Requirements'.

Under the HVDC Code, there is no specific reference to combined frequency and voltage operating range other than in respect of DC Connected Power Park Modules (Article 38) which refer back to the requirements in RfG. The legal drafting will therefore be updated to reflect this requirement for DC Connected Power Park Modules.

#### **4.4. RfG – Reactive Capability and Voltage Control**

##### **4.4.1. Type B Synchronous Power Generating Modules - General Reactive Capability**

Based on the discussions of the GC0048 Workgroup it was proposed that a reactive capability range of 0.95 Power Factor lag to 0.95 Power Factor lead at Rated MW output at the Connection Point should be adopted, unless otherwise agreed with the GB System Operator or the relevant Distribution Network Operator. This reactive capability range has been selected on the basis of DNO requirements, general plant capability and equitable treatment with Power Park Modules.

##### **4.4.2. Type B Synchronous Power Generating Modules - Control Performance**

Article 17(2)(b) requires Type B Synchronous Power Generating Modules to be equipped with a permanent automatic excitation control system that can provide constant alternator terminal voltage at a selectable set point without instability over the entire operating range.

In this context it is assumed that the entire operating range covers zero MW to Rated MW over the full reactive capability range (i.e. maximum lag (under-excited) to maximum lead (over-excited)).

Practical implementation of a scheme would be dependent upon the requirement specified at the Connection Point by the Relevant Network Operator which could be voltage control, power factor control or reactive power control. However, some Workgroup members were concerned that this would apply a more stringent<sup>6</sup> requirement on newly connecting parties.

##### **4.4.3. Type C and D Synchronous Power Generating Modules**

###### **4.4.3.1. Reactive Power Capability**

When operating at maximum capacity, this is defined based on a U-Q/Pmax profile (i.e. a (voltage – reactive power)/Maximum Power Output profile) at the Connection Point.

Under RfG, the reactive capability is defined in terms of a Q/Pmax range rather than the current GB convention of Power Factor. The use of Q/Pmax does have

---

<sup>6</sup> The background associated with 'more stringent' obligations is explored later in this section under 'Potential Alternatives (a) Removing More Stringent Requirements'.

the advantage that its value remains the same irrespective of the MW loading of the Generator unlike Power Factor which will vary as the MW loading starts to drop below its maximum. The same approach is also adopted for Power Park Modules.

To convert between Power Factor and Q/Pmax the following derivation is shown.

$$S = \sqrt{3}VI$$

$$Q = \sqrt{3}VISin\phi$$

$$P = \sqrt{3}Cos\phi \text{ where the Power Factor is defined as } Cos\phi$$

$$\frac{Q}{P} = \frac{\sqrt{3}VISin\phi}{\sqrt{3}VICos\phi} = Tan\phi = Tan(arccos\phi) = Tan(arcos(\text{Power Factor}))$$

$$Q/P_{max} = Tan(arccos(\text{Power Factor}))$$

or

$$\text{Power Factor} = Cos[Arctan(Q/P_{max})]$$

For a Synchronous Power Generating Module, the proposed U-Q/Pmax profile adopted is shown below in figure 4.2.

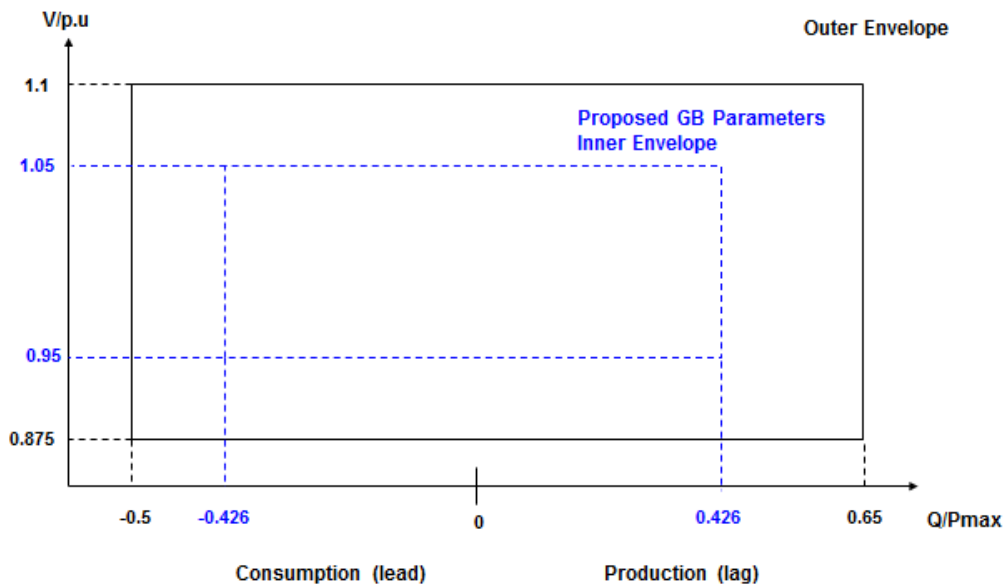

Figure 4.2 Proposed U-Q/Pmax profile

Translating this into a Voltage / Power Factor diagram results in the following diagram figure 4.3:

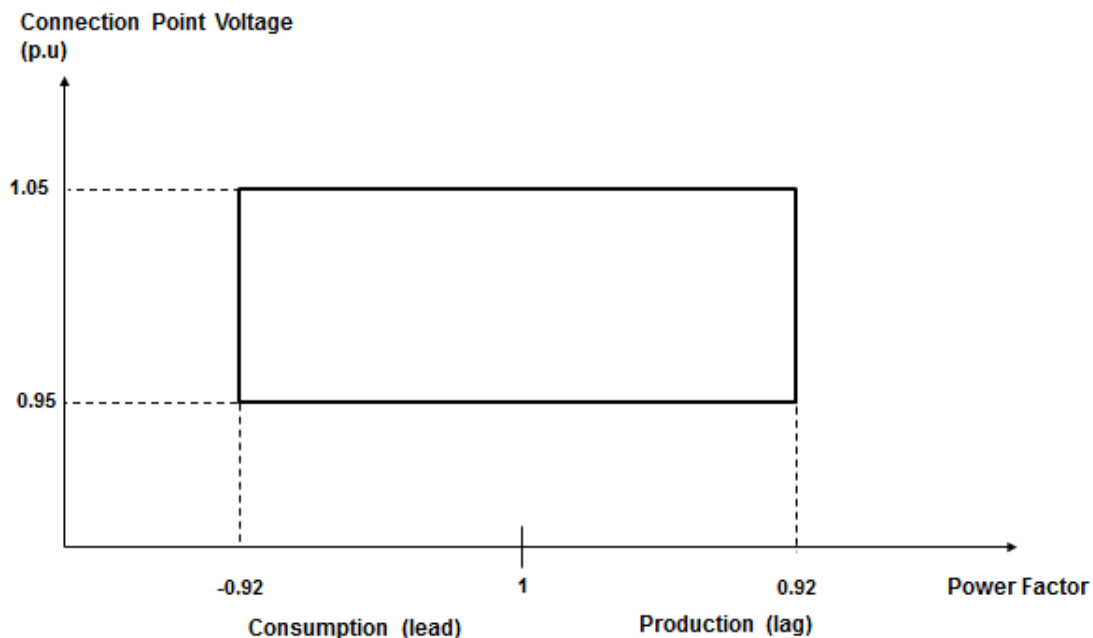

Figure 4.3 Resulting Voltage/Power Factor diagram from proposed U-Q/Pmax

For operation below maximum capacity then Type C and Type D Synchronous Power Generating Modules would be required to follow the Generator Performance Chart.

#### 4.4.4. Type C and D Synchronous Power Generating Modules

##### 4.4.4.1. Excitation Performance Requirements

In GB the excitation performance requirements are specified in CC.A.6 of the Grid Code. The GB requirements are broadly the same as those specified in RfG other than in respect of a Stator Current Limiter which will require amendment to the legal text. This issue has been accounted for and included in the revised legal text. A summary of the RfG requirements and the current

European Requirement	GB Requirement
Parameters and Settings including Transient and Steady State voltage control– (Art 19 (2)(a)&(b))	Steady State and Transient Voltage Control parameters covered in CC.A.6.2.3 and CC.A.6.2.4
Bandwidth limitation – (Art 19(2)(b)(i))	Bandwidth limitation – (CC.A.6.2.5.5)
Under Excitation Limiter – Art 19(2)(b)(ii)	Under Excitation Limiter – (CC.A.6.2.7)
Over Excitation Limiter – Art 19(2)(b)(iii)	Over Excitation Limiter – (CCA.6.2.8)
Stator Current Limiter – Art 19(2)(b)(iv)	Not explicitly defined
PSS Function – Art 19(2)(b)(v)	Power System Stabiliser – (CC.A.6.2.5)

GB obligations are summarised in Table 4.3 below.

Table 4.3 Current GB obligations v RfG requirements

As part of RfG implementation it is proposed to have the same excitation performance requirements for Type C and D Power Generating Modules other than in respect of Type C not requiring the need to have a Power System Stabiliser. The legal text has been updated to reflect this amendment.

#### 4.4.5. Type C and D Power Park Generating Modules

##### 4.4.5.1. Reactive Capability during Normal Operation

In terms of the capability requirements of Type C and D Power Generating Modules there is a difference in the performance requirements depending on whether the connection voltage is above or below 33kV as follows. For

connections points with a voltage above 33kV the U-Q/Pmax profile shown in figure 4.4 shall apply and for connection voltages below 33KV the U-Q/Pmax profile shown in figure 4.5 shall apply.

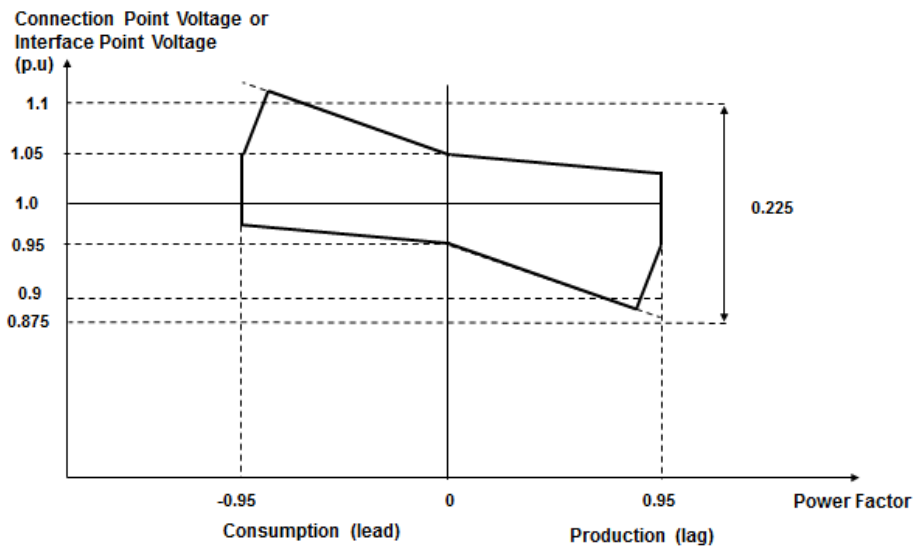

Figure 4.4 U-Q/Pmax profile for a Type C or D Power Park Module with a Connection Point above 33kV:

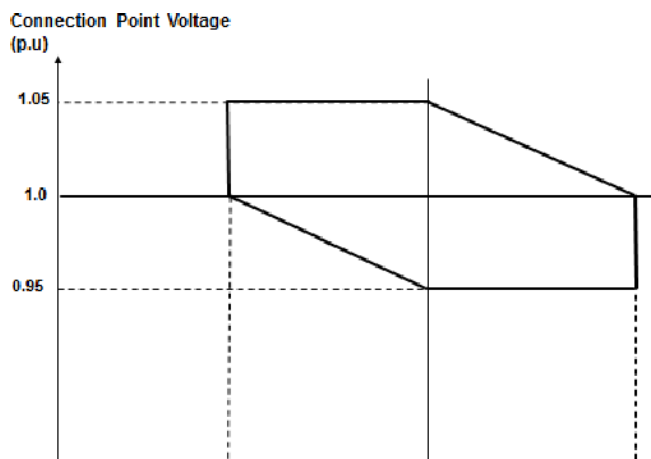

Figure 8.16(c)

Figure 4.5 U-Q/Pmax profile for a Type C or D Power Park Module with a Connection Point at or below 33kV (NB most would be Distribution-connected)

#### 4.4.5.2. Reactive Capability below Maximum Capacity

When operating below maximum capacity, the PPM is required to satisfy a Power – Reactive Power / Pmax ( $P - Q/P_{max}$ ) requirement.

The current reactive capability requirements of CC.6.3.2 can be mapped directly into RfG Article 21(3)(c) other than conversion of Power Factor into Q/Pmax.

However, some Workgroup members were concerned that this would apply a more stringent<sup>7</sup> requirement on newly connecting parties.

The proposed GB requirement is therefore shown below in figure 4.6

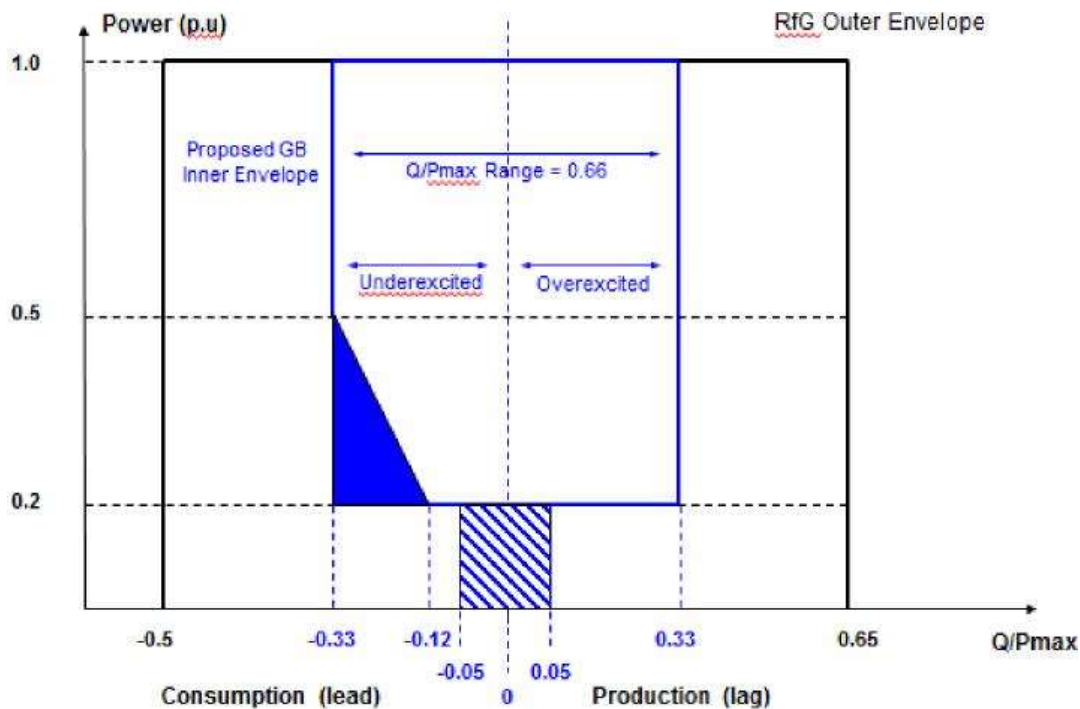

Figure 4.6 P – Q Capability diagram of a Type C and Type D Power Park Module at the Connection Point

For Type C and Type D Power Generating Modules which are distribution connected, and not subject to a Connection Agreement with the GB System Operator, the Distribution Code may obligate such Generators to meet the requirements of the Grid Code through similar arrangements adopted for LEEMPS. However, some Workgroup members were concerned that this would apply a more stringent<sup>8</sup> requirement on newly connecting parties.

#### 4.4.5.3. Reactive Power Control Modes

There are three principle ways in which reactive power can be controlled from a Power Generating Module –

- voltage control;
- reactive power control; or
- power factor control

<sup>7</sup> The background associated with ‘more stringent’ obligations is explored later in this section under ‘Potential Alternatives (a) Removing More Stringent Requirements’.

<sup>8</sup> The background associated with ‘more stringent’ obligations is explored later in this section under ‘Potential Alternatives (a) Removing More Stringent Requirements’.



Under RfG Article 21(3)(d)(vii) the relevant System Operator in coordination with the Relevant TSO shall specify which of the above three reactive power control modes applies.

In general, voltage control is the principle reactive control method on the Transmission System. Going forward, this practice would continue to apply although flexibility would remain in the code for Power Factor control or Reactive Power control was necessary for site specific reasons.

#### **4.4.5.4. Reactive Power Control**

As described above, Reactive Power Control will not be required from Type C and Type D Power Park Modules unless otherwise specified.

Where a requirement for Reactive Power Control is specified, it would need to satisfy the requirements of RfG Article 21(3)(d)(v).

#### **4.4.5.5. Power Factor Control**

Similar to Reactive Power Control, Power Factor control will not be required from Type C and Type D Power Park Modules unless otherwise specified in the Connection Agreement.

Where a requirement for Power Factor Control is specified, it would need to satisfy the requirements of RfG Article 21(3)(d)(vi).

### **4.4.6. Type B Synchronous Power Generating Modules**

#### **4.4.6.1. General Reactive Capability requirements**

RfG - Article 20(2)(a) states “with regard to reactive power capability, the relevant System Operator shall have the right to specify the capability of a power park module to provide reactive power”.

### **4.4.7. Type B Power Park Modules requirements**

#### **4.4.7.1. Reactive Capability requirements**

RfG effectively leaves this choice to the relevant System Operator. For a Transmission-connected Power Park Module, current GB Grid Code practice would be for a reactive capability of 0.95 Power Factor Lag to 0.95 Power Factor Lead at Rated MW output at the Connection Point.

For a DNO connected Power Park Module which falls outside the remit of the Grid Code, the GB reactive capability requirements are specified in the Distribution Code and G59/3.

To ensure the requirements therefore remain as flexible as possible, it is proposed that Type B Power Park Modules would be required to have a reactive capability range of 0.95 Power Factor lag to 0.95 Power Factor lead at

Maximum Capacity unless otherwise agreed with NGET or the relevant Distribution Network Operator.

#### **4.4.7.2. Control Performance requirements**

RfG does not specify any form of reactive power control mode (e.g. voltage control, reactive power control or power factor control) from a Type B Power Park Module.

As part of the GC0048 Workgroup, this issue was discussed at length and is covered in section 9.3 and 9.10 – 9.12 of the GC0048 consultation (Reference [1]). Voltage control would generally be the preferred choice for both Transmission and Distribution-connected generation, however the code has been drafted to allow the Relevant System Operator to determine the method of reactive control on a case by case basis and as the need arises. However, some Workgroup members were concerned that this would apply a more stringent<sup>9</sup> requirement on newly connecting parties.

### **4.5. AC Connected Offshore Power Park Modules**

#### **4.5.1. Offshore Configuration**

RfG Article 23 defines the requirements for AC connected Power Park Modules. These are classified into two categories:

4.5.1.1. **Configuration 1:** AC connection to a single onshore Grid interconnection point whereby one or more Offshore Power Park Modules that are interconnected offshore to form an Offshore AC System are connected to the Onshore System

4.5.1.2. **Configuration 2:** Meshed AC connections whereby a number of Offshore Power Park Modules are interconnected Offshore to form an Offshore AC System and the Offshore AC System is connected to the Onshore System at two or more Grid Interconnection Points.

4.5.1.3. For any Power Park Module which is connected to an HVDC System, the requirements of the HVDC Network Code shall apply.

#### **4.5.2. Offshore Voltage Range**

RfG Article 25(1) defines the steady state voltage operating range for AC Connected Offshore Power Park Modules

CC.6.1.4 of the Grid Code currently defines the steady state operating range of all User's connected to the Transmission System which includes Offshore

---

<sup>9</sup> The background associated with 'more stringent' obligations is explored later in this section under 'Potential Alternatives (a) Removing More Stringent Requirements'.

## Generating Units and Offshore Power Park Modules connected to Offshore Transmission Systems

CC.6.1.4 and RfG Article 25(1) are similar, however the GB Code requires the voltage range applicable to User's connected below 132kV should be within  $\pm 6\%$  and RfG requires AC Connected Offshore Power Generating Modules connected between 132kV and 110kV to remain within the limits of  $\pm 10\%$ . However, some Workgroup members were concerned that this would apply a more stringent<sup>10</sup> requirement on newly connecting parties.

It is not envisaged that this will have any significant impact on current GB practice where equipment rated at a nominal voltage of between 132kV and 110kV are generally used

All other requirements relating to voltage range are the same as the onshore requirement

### **4.5.3. Offshore Reactive Capability requirements**

The Reactive Capability requirements for AC connected Offshore Power Park Modules are broadly the same as those for Type C and Type D Onshore Power Park Modules as defined in Article 21(3), other than in respect of the parameters which are redefined in Table 11 of RfG

For Configuration 1 Offshore AC Connected Power Park Modules the maximum range of Q/Pmax is set to zero (i.e. unity power factor) and for Configuration 2 Offshore AC Connected Power Park Modules the maximum range of Q/Pmax is set to 0.33.

Both Configuration 1 and Configuration 2 have a maximum steady state voltage range of 0.225pu. The voltage range remains unchanged at 0.225pu. The following requirements for Configuration 2 AC connected Power Park Modules are shown below in figures 4.6 and 4.7.

As part of the GC0048 consultation one of the main comments received was the restricted capability particularly in respect of Configuration 1 AC Connected Offshore Power Park Modules being set at Unity Power Factor and the option of using a commercial agreement to utilise a wider range if agreed between National Grid, the Offshore Transmission Licensee and Generator. In respect of these comments it has been decided to update the legal text so that Offshore Generators (irrespective of whether they are configuration 1 or configuration 2) should meet the minimum requirement set out in the EU Network Codes but there is no restriction on generators providing, if they wish to, a wider range so long as this is agreed between the GB System Operator, the Offshore Transmission Licensee and Generator.

---

<sup>10</sup> The background associated with 'more stringent' obligations is explored later in this section under 'Potential Alternatives (a) Removing More Stringent Requirements'.

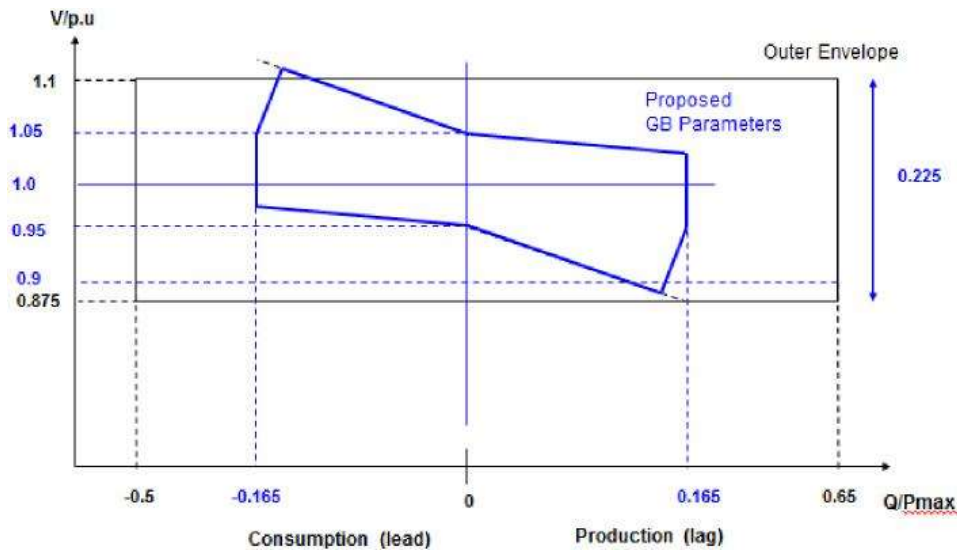

Figure 4.6 Configuration 2 - AC connected Offshore Power Park Module U-Q/Pmax Profile

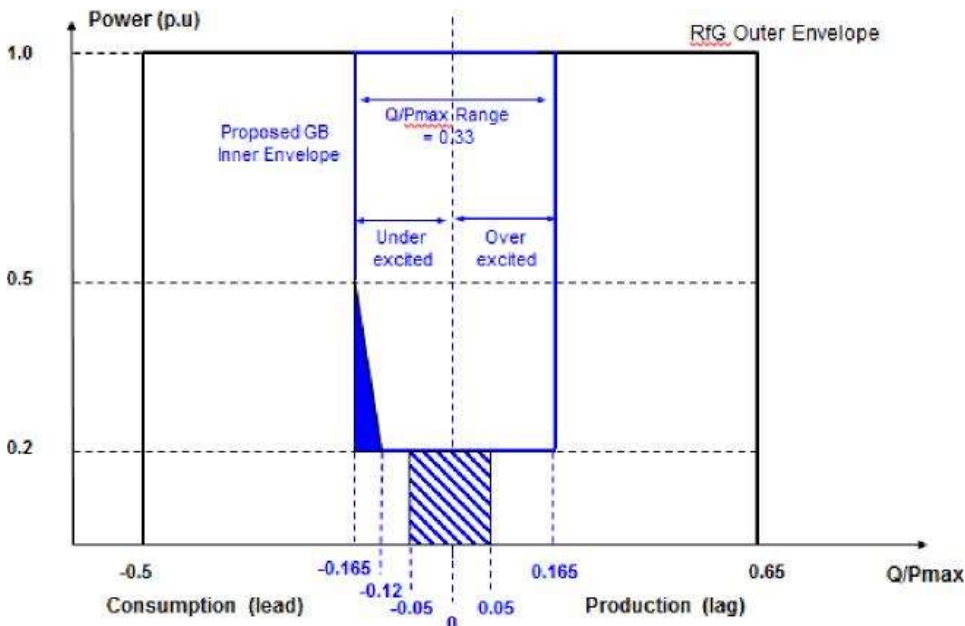

Figure 4.7 Configuration 2 - AC connected Offshore Power Park Module P-Q/Pmax Profile

For Configuration 1 AC connected Power Park Modules the Reactive Capability at the Offshore connection point is fixed at unity power factor i.e. zero transfer of reactive power. There does not appear to be any tolerance (e.g.  $\pm 5\%$ ) on the tolerance of reactive power imported or exported to the transmission system

Notwithstanding this, Article 21(3)(d)(v) defines the requirements for Reactive Power control which states where reactive power control is employed, reactive power should be controlled with an accuracy of  $\pm 5$  MVAR or  $\pm 5\%$  of the full reactive power).

Interpretation of this requirement would therefore imply that this tolerance should also apply to Configuration 1 AC connected Offshore Power Park Module.

#### 4.6. Post Workgroup Consultation discussions

The Workgroup met on the 5 October to review the eleven Workgroup Consultation responses, these can be located in Annex 6.

The Proposer noted that there were a number of areas where they could address the proposed amendments to the proposed legal text. The Proposer subsequently addressed the amendments requested and the final proposed legal text can be located in Annex 1.

#### Workgroup Vote

The Workgroup met on the 6 December 2017 to vote. The details of this are below. Fifteen of the sixteen Workgroup members voted that the Original solution proposed better facilitated the Grid Code objectives. One Workgroup member stated that they would be abstaining from the best option vote.

Workgroup member	Grid Code Objectives					Overall
	(a)	(b)	(c)	(d)	(e)	
Alan Creighton						
Original	Y	Y	N	Y	Y	Y
Voting Statement: Both the Original and the Alternative are better than the baseline in that they implement the EU RfG Network Code, they promote competition in that they harmonise generation plant requirements and hence help improve overall efficiency.						
Alastair Frew						
Original	Neutral	Neutral	Neutral	Yes	Neutral	Yes
Voting Statement: This option implements EU regulations.						
Andrew Vaudin						
Original	N	Y	Y	Y	N	Y
Voting Statement:						
Chris Marsland						
Original	Y	Y	Y	Y	Y	Y
Voting Statement: When compared to the baseline, this proposal better facilitates the objectives as it implements our legal obligations under the network codes.						
Christopher Smith						
Original	Y	Y	Y	Y	Y	Y
Voting Statement: meets EU code requirements						
David Spillett						
Original	Y	Y	Y	Y	Y	Y
Voting Statement: this proposal is better than the baseline in that it implements necessary legal compliance.						

Garth Graham						
Original	Neutral	Yes	Neutral	No	No	No
<p>Voting statement: "The Original is, on the face of it, better in terms of better facilitating competition in the generation and supply of electricity as the EU Network Codes will achieve this.</p> <p>However, the Original (based on the legal text available prior to the vote on 6th December 2017) is more stringent than what is set out in the relevant legally binding decisions of the European Commission and thus the proposal(s) does not therefore efficiently discharge the obligations imposed upon the licensee.</p> <p>Furthermore, given that the Original is not better in respect of the relevant legally binding decisions of the European Commission the Original does not better promote efficiency in the implementation and administration of the Grid Code arrangements</p> <p>Accordingly, overall the Original is not better."</p>						
Graeme Vincent						
Original	Y	-	Y	Y	-	Y
Voting Statement: Implements the requirements of the European regulations and is therefore better than the baseline.						
Gregory Middleton						
Original	Y	Y	Y	Y	Y	Y
Voting Statement: When compared to the baseline, this proposal better facilitates the objectives as it implements our legal obligations under the network codes.						
Isaac Gutierrez						
Original	Y	Y	Y	Y	Y	Y
Voting Statement: Requirements can be met by generating plant available currently in the market (wind in particular) as per SPR own due diligence						
Marko Grizelj						
Original	Y	Y	Y	Y	Y	Y
Voting Statement: The original facilitates the objectives better than the baseline as it ensures compliance with EU regulation.						
Mick Barlow						
Original	Yes	Yes	Yes	Yes	Yes	Y
Voting Statement: Baseline is non-compliant						
Mike Kay						
Original	-	-	Y	Y	-	Y
Voting Statement: This is better than the baseline in that it provides legal compliance with the RfG						
Paul Youngman						
Original	-	-	Y	Y	-	Y
Discharges obligations of EU RFG-ensuring industry compliance						
Peter Woodcock						
Original	Y	Y	Y	Y	N	Y
Voting Statement: As this is the only option which complies with the European Network Code, it is the best option.						
Rob Wilson						
Original	Y	-	Y	Y	-	Y
Voting Statement: The original proposal is better than the baseline as it achieves ENC						

compliance.

**Vote 2: which option is considered to BEST facilitate achievement of the Applicable Grid Code Objectives. For the avoidance of doubt, this includes the existing baseline as an option.**

<b>Workgroup member</b>	<b>BEST Option</b>
Alan Creighton	Original
Alastair Frew	Original
Andrew Vaudin	Original
Chris Marsland	Original
Christopher Smith	Original
David Spillett	Original
Garth Graham	Did not vote
Graeme Vincent	Original
Gregory Middleton	Original
Isaac Gutierrez	Original
Marko Grizelj	Original
Mick Barlow	Original
Mike Kay	Original
Paul Youngman	Original
Peter Woodcock	Original
Rob Wilson	Original

## 5 Alternatives

During the Workgroup meetings a potential alternative to the Original proposal was explored by members of the Workgroup. This potential alternative was related to (a) removing more stringent requirements - this is explored further below.

### (a) Removing More Stringent Requirements

At the second Workgroup meeting<sup>11</sup> the Proposer confirmed that it was the intention, with GC0101 that all the existing obligations placed on new connecting parties within the (GB) national network codes (such as, but not limited to, the Grid Code, the Distribution Code, the Engineering Requirements, the CUSC etc.) would continue (with the GC0101 original proposal) to be applied to future parties connecting under the RfG, DCC and HVDC Network Codes. In other words the obligations in those EU Network Codes would be applied to future parties connecting as well as the additional national network code obligations - it was not intended that, in principle, any obligations for future connecting parties

---

<sup>11</sup> Held on 6<sup>th</sup> July 2017

would be removed from the national network codes as a result of the GC0101 original proposal.

However, a Workgroup member identified that this appeared to be incompatible with the requirements of the Third Package, and in particular Articles 8(7) and 21 of Regulation 714/2009<sup>12</sup>.

*Article 8(7)*

*“The network codes shall be developed for cross-border network issues and market integration issues and shall be without prejudice to the Member States’ right to establish national network codes **which do not affect cross-border trade.**”* [emphasis added]

*Article 21*

*“This Regulation shall be without prejudice to the rights of Member States to maintain or introduce measures that contain **more detailed** provisions than those set out herein or in the Guidelines referred to in Article 18.”* [emphasis added]

The Workgroup member highlighted that when the RfG was first drafted by ENTSOE (noting that the proposer of GC 0101, National Grid, was an active member of the RfG drafting team for ENTSOE) they had included an Article 7, which was subsequently deleted by the Commission on 14th January 2014.

That old Article 7 said the following:

*“This Network Code shall be **without prejudice to the rights of Member States to maintain or introduce measures that contain** more detailed or **more stringent provisions than those set out herein**, provided that these measures are compatible with the principles set forth in this Network Code.”* [emphasis added]

The Workgroup member noted that the wording of particular relevance to the current discussions are the parts emphasised in bold.

The Workgroup member stated that in their opinion it was clear, by their drafting, that ENTSOE intended to be able to maintain (or introduce later) requirements contained in the exiting national network codes<sup>13</sup> where those requirements were (or could be in the future) more stringent than the provisions set out in the EU Network Codes.

The Commission explicitly removed this proposed wording by ENTSOE.

Shortly after the Commission's deletion of the old Article 7 in January 2014, and at the prompting of GB stakeholders (including the Workgroup member who raised this potential alternative) Ofgem enquired of the Commission as to why that article had been deleted.

---

<sup>12</sup> <http://eur-lex.europa.eu/LexUriServ/LexUriServ.do?uri=OJ:L:2009:211:0015:0035:EN:PDF>

<sup>13</sup> Such as, but not limited to, the Grid Code, the Distribution Code, the Engineering Requirements, the CUSC etc., in GB



In their response dated 28th February 2014, the Commission wrote to Ofgem in the following terms which was shared with GB stakeholders

*“1. that Article 21 of Regulation (EC) No 714/2009 already provided for the possibility for Member States to adopt **more detailed** measures and that there was thus no need to reiterate this possibility in the ENC RfG”* [emphasis added]

*“2. **the adoption by Member States of measures more stringent than the ones of the ENC RfG** (to the extent of measures with cross-border trade effect) **would not be in line with Article 21 of Regulation (EC) No 714/2009**, i.e. if the Member states were to adopt more stringent measures then it should be proved that there is no cross border trade effect of doing so”* [emphasis added]

Over a year later, on 26th June 2015, the RfG (and later the DCC and HVDC) Network Code was approved via the Comitology procedure, noting that in doing so, it:

*“...**provide[s] a clear legal framework for grid connections**, facilitate Union-wide trade in electricity, ensure system security, facilitate the integration of renewable electricity sources, increase competition and allow more efficient use of the network and resources, for the benefit of consumers”<sup>14</sup>* [emphasis added]

As part of that approval process an arrangement was put in place by DECC (later BEIS) and Ofgem to canvass GB stakeholder views on any 'red line' items that the stakeholder(s) believed that DECC and Ofgem should seek to change in each of the respective EU Network Code prior to its approval. The Workgroup member could not recall National Grid identifying, as one of its 'red line' items, the need to allow for more stringent obligations (to those set out in the EU Network Codes) being placed on future connecting parties in GB.

The Workgroup member was also unaware of any other TSO in other Member States having, likewise, raised any similar concerns in respect of more stringent obligations in the intervening seventeen month period (from mid January 2014 to late June 2015) as the RfG Network Code was proceeding through the approvals process.

The Workgroup member stated that in the intervening seventeen month period TSOs could, if they believed this issue to be important, have put forward 'more stringent' obligations if they were required; such as those, for example, needed for maintaining the security of the electrical system; for inclusion in the EU Network Codes. If this had been done at the time then, as such, they would not, in law, be 'more stringent' in terms of Article 8(7) or Article 21 as any obligation(s) would not be in the national network codes (but rather in the EU Network Codes).

---

<sup>14</sup> RfG, 14<sup>th</sup> April 2016, Recital 3

However, this was not done by the TSOs, despite there being time for them to do so if they wished.

The Workgroup member went on to explain that as part of the implementation of the EU Network Codes arrangements have been put in place for stakeholder involvement going forward (this is, for example, set out in Article 11 of the RfG, Article 10 of the DCC and Article 11 of the HVDC).

As a result a ('combined') stakeholder committee for the three connections codes<sup>15</sup> (RfG, DCC and HVDC) was established in 2016. Chaired by ACER, with secretariat support from ENTSOE it brings together pan European trade associations etc., of stakeholders with interest in the three EU Network Codes relating to connections.

The Workgroup member stated that one of the questions that arose early on in the life of the connections codes stakeholder committee was around applying more stringent requirements within the national network codes.

This question was posed to the Commission in the following terms:

*"Can a Member State impose more stringent requirements by a separate legislation than imposed by the network code Requirements for Generators (RfGNC)?"*

The Commission's answer to the question was provided in its presentation to the stakeholder committee on 8th September 2016 (which was subsequently repeated at the 9th December 2016 and 7th June 2017 meetings). The answer is as follows:

**"In general, no – not outside of the values provided for in the code.** [emphasis added]

*•But: "the relevant system operator, in coordination with the relevant TSO, and the power-generating facility owner **may agree** on wider frequency ranges, longer minimum times for operation or specific requirements for combined frequency and voltage deviations to ensure the best use of the technical capabilities of a power-generating module, if it is required to preserve or to restore system security." Article 13. [emphasis added]*

*•"The network codes shall be developed for cross-border network issues and market integration issues and shall be without prejudice to the Member States' right to establish national network codes **which do not affect cross-border trade.**" Article 8, Regulation 714." [emphasis added]*

---

<sup>15</sup> Further details, including papers / minutes etc., can be found at <https://www.entsoe.eu/major-projects/network-code-implementation/stakeholder-committees/Pages/default.aspx>

This issue had also been brought to the attention of GB stakeholders in the spring of 2014 via a presentation which was given to meetings of the three relevant GB stakeholder bodies at that time (ECCAFF, JESG and the joint DECC/Ofgem Stakeholder Group).

That spring 2014 presentation was also shared with the GC0101 Workgroup prior to meeting 3<sup>16</sup> and can be found on the GC0101 National Grid website area. The Workgroup member highlighted a number of points in that presentation (some of which have been set out already in the above few paragraphs so are not repeated here), including:

– *Firstly: burden of proof to say a particular “more stringent” national measure (over and above the ones of the ENCs) does not affect cross border trade resides with the Member State (not stakeholders)*

– *Secondly: the presumption for all “more stringent” national measures (over and above the ones of the ENCs) is that they are not legally binding unless and **until the Member State** (not stakeholders) **has “proved that there is no cross border trade effect”**<sup>17</sup> [emphasis added]*

“• *In terms of Art 8 and Art 21 what do “...which do not affect cross-border trade...” and “... no cross border trade effect...” mean?*

• *Important to be mindful of very strong ENTSOe arguments about Type A generators – individually an 800W generator will not affect cross border trade but, cumulatively, they will have an affect on cross border trade”<sup>18</sup>*

“• *Single GB code\* requirement:*

- *on one generator, maybe a case of there being no cross border affect?*
- *cumulatively on multiple generators, a case that there is an affect?*

• *Multiple GB code\* requirements:*

- *cumulatively on one generator, some cross border affect?*
- *cumulatively on multiple generators, a clear affect?*

• *All GB code\* requirements:*

- *cumulatively on one generator, some cross border affect?*
- *cumulatively on multiple generators, a clear affect?*

*\* document(s) where national requirements are set out - such as GC, DC, DCUSA, BSC, CUSC, Engineering Recommendations (G59 / G83) etc.”<sup>19</sup>*

In respect of the affect on cross border trade of obligating future connecting parties in GB, such as generators<sup>20</sup>, to meet more stringent requirements than

---

<sup>16</sup> Held on 3<sup>rd</sup> August 2017

<sup>17</sup> Slide titled ‘Another point of view (3)’

<sup>18</sup> Slide titled ‘Another point of view (4)’

<sup>19</sup> Slide titled ‘Another point of view (5)’

those set out in the respective EU Network Code, the Workgroup member highlighted to the Workgroup twelve examples of additional costs etc., which, in that scenario, a generator could (would?) face.

These examples were:

- 1) *“pay for the extra obligations to be assessed and the solutions identified;*
  - 2) *pay for the extra equipment or pay for the extra procedures to be developed to meet the extra obligations;*
  - 3) *pay for the operation and maintenance of the extra equipment;*
  - 4) *pay for the extra operational costs of the procedures (including extra staff);*
  - 5) *pay for the extra equipment and procedures to be internally(\*) tested (prior to the network operator compliance testing);*
  - 6) *pay for the network operator’s compliance testing of the extra equipment and procedures;*
  - 7) *have to include a risk premium for items (5) and (6) in terms of if the tests are failed or delayed and either (a) remedial actions / costs are incurred to put this right and / or (b) the delay results in the plant not commissioning on time (delaying the revenue income being received);*
  - 8) *in respect of (7) if the tests under items (5) and (6) fail, then pay for the extra equipment/ procedures changes plus the (re) testing of these elements (or the full rerun of the testing);*
  - 9) *pay for the replacement costs of the extra equipment either at the end of its design life or if the equipment fails during its operational lifetime;*
  - 10) *have to include a risk premium for the failure of the extra equipment resulting in the plant being non compliant and the plant being placed off line till the repairs or replacement can be undertaken;*
  - 11) *in terms of (10) pay for the (re) testing (internal and / or compliance) of the repaired / replaced extra equipment; and (last, but not least)*
  - 12) *pay the capital cost for all these extra items above, noting that last time we look as an industry at this, the WACC of GB generators was over twice and in some cases more than quadruple that of network operators.*
- (\*) the test is undertaken for the internal purposes of the generator, although the actual testing itself maybe undertake by an external provider, such as the equipment supplier.”<sup>21</sup>*

---

<sup>20</sup> But not limited to generators - the DCC Network Code concerns demand connections and the HVDC Network Code deals with the connection of HVDC systems.

<sup>21</sup> Shared with the Workgroup by email on 3<sup>rd</sup> August 2017

The Workgroup member noted that this list is not comprehensive and that other generators may identify additional items that have, inadvertently, been omitted. (e.g costs associated with compliance with other codes such as mandatory participation in the balancing mechanism for 132 kV connected generators in Scotland > 10 MW) (?)

In the view of the Workgroup member it was clear that the cumulative effect, of all these additional costs<sup>22</sup>, on multiple generators in GB, would affect cross border trade; although the Workgroup member acknowledged, as per the Commission's statement<sup>23</sup> of 28th February 2014 to Ofgem, that it was not for the stakeholder, such as a generator, to prove that there was a cross border trade affect, but rather for *those who wish to apply more stringent requirements* (than those in the EU Network Codes) to prove that there is no cross border trade effect of doing so.

The Workgroup member was mindful that the GC0101 proposals would, in due course, be presented to the National Regulatory Authority (Ofgem) for determination. In this context, the Workgroup member was alive to the duty placed upon Ofgem (as the NRA for GB) "to ensure compliance with European Union Law". This was summarised under duties of the regulatory authority; in the Commission's interpretive note on Directive 2009/72 concerning the common rules for the internal market in Electricity (and the Gas equivalent) dated 22nd January 2010<sup>24</sup>; in the following terms:

*"Article 37(1)(b) of the Electricity Directive and Article 41(1)(b) of the Gas Directive state that the NRA has the duty of 'ensuring compliance of transmission and distribution system operators, and where relevant, system owners, as well as of any electricity and natural gas undertakings, with their obligations under this Directive and other relevant Community legislation, including as regards cross border issues'.*

It follows from this provision that, without prejudice to the rights of the European Commission as guardian of the Treaty on the functioning of the European Union, the NRA is granted a general competence — and the resulting obligation — as regards ensuring general compliance with European Union law. The Commission's services are of the opinion that Article 37(1)(b) of the Electricity Directive, and Article 41(1)(b) of the Gas Directive, are to be seen as a provision guaranteeing that the NRA has the power to ensure compliance with the entire sector specific regulatory '*acquis communautaire*' relevant to the energy market, and this vis-à-vis not only the TSOs but any electricity or gas undertaking."<sup>25</sup>

In light of the above, and given the statement from the GC0101 Proposer noted at the start of this item; together with the presentations (and associated

---

<sup>22</sup> Arising from having to comply with the more stringent national network code obligations which go beyond what is required by the EU Network Code(s)

<sup>23</sup> *"if the Member states were to adopt more stringent measures then it should be proved that there is no cross border trade effect of doing so"*

<sup>24</sup> [https://ec.europa.eu/energy/sites/ener/files/documents/2010\\_01\\_21\\_the\\_regulatory\\_authorities.pdf](https://ec.europa.eu/energy/sites/ener/files/documents/2010_01_21_the_regulatory_authorities.pdf)

<sup>25</sup> Found at pages 14-15 of the Commission's interpretive note.

discussions of the ‘more stringent’ point in terms of compliance) at the 24<sup>th</sup> July 2017 ‘Compliance with the RfG’ hosted at the ENA; the Workgroup member believed that the original proposal (by virtue of not removing ‘more stringent’ requirements contained within the GB national network codes, that it was proposed to apply to future GB connecting parties) would be incompatible with EU law for the reasons set out above<sup>26</sup> and would thus also not better facilitate Grid Code Applicable Objective (d)<sup>27</sup>:

*“To efficiently discharge the obligations imposed upon the licensee by this license and to comply with the Electricity Regulation and any relevant legally binding decisions of the European Commission and/or the Agency”*

Therefore, the Workgroup proposed to bring forward an alternative proposal to the GC0101 original proposal which would be to ensure that more stringent obligations contained within the GB national network codes would not be applicable to future connecting parties who fall within the scope of the RfG, DCC and HVDC Network Codes respectively; although, for the avoidance of doubt, those (GB) national network code obligations would continue to be applicable to ‘existing’ connected parties (as defined in the RfG, DCC and HVDC Network Codes respectively) unless and until they fall within the scope of the EU Network Codes for connection.

To set this in context the Workgroup member was mindful of the presentation given by the Proposer at the second Workgroup meeting setting out (in a tabular form) the items covered, in the case of generation, with the RfG Network Code for the four types of generation (A-D).

This table is shown below:

---

<sup>26</sup> As well as, potentially, with respect to Competition Law for the reasons outlined under Section 2 ‘Governance – Legal Requirements’ in the GC0103 proposal:

<http://www2.nationalgrid.com/UK/Industry-information/Electricity-codes/Grid-code/Modifications/GC0103/>

<sup>27</sup> Or the Distribution Code equivalent Applicable Objective (iv).

Technical Requirements	Type A	Type B	Type C	Type D
Operation across range of frequencies	•	•	•	•
Rate of change of System Frequency (ROCOF)	•	•	•	•
Limited Frequency Sensitive Mode Over Frequency (LFSM-O)	•	•	•	•
Output Power with falling Frequency	•	•	•	•
Logic Interface (input port) to cease active power production	•	•	•	•
Conditions for automatic reconnection	•	•	•	•
Operation across range of frequencies	•	•	•	•
Ability to reduce Active Power on instruction		•	•	•
Fault Ride Through and Fast Fault Current Injection		•	•	•
Conditions for automatic reconnection following disconnection		•	•	•
Protection and Control		•	•	•
Operational Metering		•	•	•
Reactive Capability		•	•	•
Active Power Controlability			•	•
Frequency Response including LFSM-U			•	•
Monitoring			•	•
Robustness			•	•
System Restoration / Black Start			•	•
Simulation Models			•	•
Rates of Change of Active Power			•	•
Earthing			•	•
Enhanced Reactive Capability and control			•	•
Voltage Ranges				•
Enhanced Fault Ride Through				•
Synchronisation				•
Excitation Performance				•

Using this summary table, the Workgroup member identified that with the potential alternative that Type A generators would only be obligated, in terms of their connection to the grid, to those items shown in the table (and so on for Types B, C and D). All other items would be considered more stringent unless it could be proven that there was no cross border trade affect of obligating generators to comply with further obligations over and above those in the RfG (and likewise in terms of the DCC for Demand and the HVDC for HCDV connecting parties).

The proposer, whilst not agreeing with the workgroup member's 'more stringent' interpretation set out above, or indeed that their own solution is 'more stringent', is satisfied that the GC0100 workgroup, the wider industry, the respective Code Panels, and in due course, the National Regulatory Authority, are capable of considering the merits of the respective proposals and that this was fully discussed during the workgroup development of the proposal.

The proposer does however note that whilst various European treaties give the EU competence in the area of energy and creation of the internal energy market,

competence on these matters is shared with the Member State. As a general principle therefore, the EU regulations do not encompass everything to do with energy; or mean that everything has to be, or should be, mandated at an EU level.

EU regulation 714/2009 and the Connection Codes themselves address this principle. Article 7 of RfG sets out 'Regulatory Aspects', including a provision in clause 3 that when applying the Regulation, Member States, competent entities and system operators shall: "(d) respect the responsibility assigned to the relevant TSO in order to ensure system security, including as required by national legislation;"

The proposer is therefore of the view that a test for stringency should solely be in respect of implementing the specific provisions in the Connection Codes. Other aspects subject to national legislation should not be subject to this test.

### **Workgroup Alternative Vote**

The GC0100 Workgroup met on the 21 November 2017 to assess whether the potential alternative outlined better facilitated the Grid Code Objectives than the baseline.

The Workgroup voted by majority that this proposal **does not** better facilitate the Grid Code objectives. The Chairman of the Workgroup stated that this potential alternative **did not** better facilitate the Grid Code Objectives and as such this potential alternative did not become a formal WACM. The Chairman noted that there had not been any specific examples provided by either the Proposer of the proposed alternative or any Workgroup members throughout the mapping session that was held on the 20 November 2017. She noted that as a result no legal text would be able to be drafted and added to the report for decision from the Authority.

As a result there are no formal Workgroup Alternative Code Modifications for GC0101. The full alternative form can be located in Annex 12.

## **6 Impact & Assessment**

### *Impact on the Grid Code*

This modification is necessary to ensure the Grid Code is consistent with the applicable European Network Code requirements identified for this modification.

To apply these requirements, a new section to the Grid Code Connection Conditions specific to EU requirements will be introduced. Users bound by these EU requirements (as determined in the Network Codes themselves) will need to comply with this new section. Existing Grid Code Users will not be bound by this a new section to the Grid



Code Connection Conditions specific to EU requirements (unless and until they fall within the scope of those EU Network Codes).

### ***Impact on the Distribution Code***

A similar approach will be taken with the Distribution Code. Existing generating equipment will continue to be bound by G59 and G83 (as appropriate to the equipment's size) which will remain unchanged. New generating equipment will be required to be compliant with two new documents, G99 and G98 (again as appropriate to size and/or compliance arrangements) which will only apply the RfG (and if appropriate HVDC) requirements to those parties in a way that that is not more stringent than the EU Network Code requirements.

### ***Impact on Greenhouse Gas Emissions***

The proposed modification should better facilitate connection of renewable low-carbon generation schemes in GB, thus having a positive impact on greenhouse gas emissions.

### ***Impact on Core Industry Documents***

Minor consequential changes are anticipated subsequent to this Grid Code modification in the STC and the Relevant Electrical Standards, to align them with the proposed changes.

### ***Impact on EU Network Codes***

This modification has been raised solely to implement EU Network Codes into existing GB regulatory frameworks in a way that is not more stringent than required by those Network Codes. It is therefore fundamental in ensuring GB Member State compliance with the EU Connection Codes specifically.

### ***Impact on Consumers***

This modification facilitates the implementation of consistent technical standards across the EU for the connection of new Generation or HVDC equipment. This should reduce development costs for new projects which should result in cost savings passed on to end consumers. Further consideration of compliance costs to these proposals is considered in the 'Costs of implementation' section below

### ***Does this modification impact a Significant Code Review (SCR) or other significant industry change projects, if so, how?***

The EU Network Code implementation is being undertaken as a significant programme of work within the GB industry. This mod forms part of that programme, but is not part of an on-going SCR

## ***Costs***

<b>Code administration costs</b>	
Resource costs	<b>£18,150</b> - 10 Workgroup meetings <b>£1,508</b> - Catering
Total Code Administrator costs	<b>£19,658</b>

<b>Industry costs (Standard GC)</b>	
Resource costs	<p><b>£ 245,025</b> - 10 Workgroup meetings</p> <p><b>£ 21,780</b>– 2 Consultations</p> <ul style="list-style-type: none"> <li>• 10 Workgroup meetings</li> <li>• 27 Workgroup members</li> <li>• 1.5 man days effort per meeting</li> <li>• 1.5 man days effort per consultation response</li> <li>• 12 consultation respondents (average over two consultations)</li> </ul>
Total Code Administrator costs	<b>£19,658</b>
Total Industry Costs	<b>£286,463</b>

## 7 Relevant Objectives – Initial assessment by Proposer

The below has been sourced from the Proposer. The Workgroup members assessed the Original proposal against the Grid Code objectives and this can be found in Section 5.

### Impact of the modification on the Applicable Grid Code Objectives ( ):

Relevant Objective	Identified impact (Positive/negative/neutral)
(a) To permit the development, maintenance and operation of an efficient, coordinated and economical system for the transmission of electricity;	Positive
(b) To facilitate competition in the generation and supply of electricity (and without limiting the foregoing, to facilitate the national electricity transmission system being made available to persons authorised to supply or generate electricity on terms which neither prevent nor restrict competition in the supply or generation of electricity);	Positive
(c) Subject to sub-paragraphs (i) and (ii), to promote the security and efficiency of the electricity generation, transmission and distribution systems in the national electricity transmission system operator area taken as a whole;	Positive
(d) To efficiently discharge the obligations imposed upon the licensee by this license and to comply with the Electricity Regulation and any relevant legally binding decisions of the European Commission and/or the Agency; and	Positive
(e) To promote efficiency in the implementation and administration of the Grid Code arrangements	Neutral

The EU Connection Codes derive from the Third Energy Package legislation which is focused on delivering security of supply; supporting the connection of new renewable plant; and increasing competition to lower end consumer costs. It therefore directly supports the first three Grid Code and Distribution Code objectives.

Furthermore, this modification is to ensure GB compliance of EU legislation in a timely manner, which positively supports the fourth Grid Code and Distribution Code applicable objectives.

## 8 Implementation

This modification must be in place to ensure the requirements of the EU Connection Codes are set out in the GB codes by two years from the respective Entry Into Force dates (set out earlier in this paper).

It is therefore crucial that this work is concluded swiftly to allow the industry the maximum amount of time to consider what they need to do to arrange compliance.

Please note that this modification is required to be implemented on the 16 May 2018.

## 9 Code Administrator Consultation summary

The Code Administrator Consultation opened on the 12 January 2018 for 15 working days closing on the 2 February 2018. Eleven responses were received and are summarised on the following pages. The full responses can be found in Annex 10.

Response	Q1: Do you believe GC0101 better facilitates the Applicable Grid Code Objectives? Please include your reasoning	Q2: Do you support the proposed implementation approach? If not, please provide reasoning why.	Q3: Do you have any other comments?
<i>Andy Vaudin, EDF Energy</i>	Yes. This modification enables the Grid Code to be consistent with the applicable European Network Code requirements.	Yes	None
<i>Bernard Gospel, Association of Manufacturers of Power Generating Systems (AMPS)/Association of Decentralised Energy (ADE) (Joint Submission)</i>	The original better facilitates the Grid Code objectives than the baseline as it implements the RfG requirements.	Yes	<p>We support the general principle that has been applied in developing this mod of matching the existing Grid Code requirements wherever possible.</p> <p>We have discovered what we believe is a serious defect in the drafting of ECC 6.3.7.1.2 and ECP A.5.8 as far as Type B PGMs is concerned. Type B is only required to have LFSM-O, but ECP only has a test regime that assumes FSM.</p> <p>Further, there is not clarity about what “as much as possible” means in practice in ECC 6.3.7.1.2(iii). We believe you understand the unmeetable challenge that this drafting makes for diesel/gas driven synchronous PGMs in the 1-5MW size range. We believe that more work is urgently needed to modify the legal text here (and the consequential requirements in G99).</p> <p>We would be happy to work with NG and the DNOs to achieve an rapid modification of this text as soon as possible given the necessary change processes.</p>
<i>Greg Middleton, Deep Sea Electronics Plc</i>	The original better facilitates the Grid Code objectives than the baseline as it implements the RfG requirements.	Yes	We support the general principle that has been applied in developing this mod of matching the existing Grid Code requirements wherever possible.
<i>Steve Cox, Electricity North</i>	Yes	Yes	No further comments

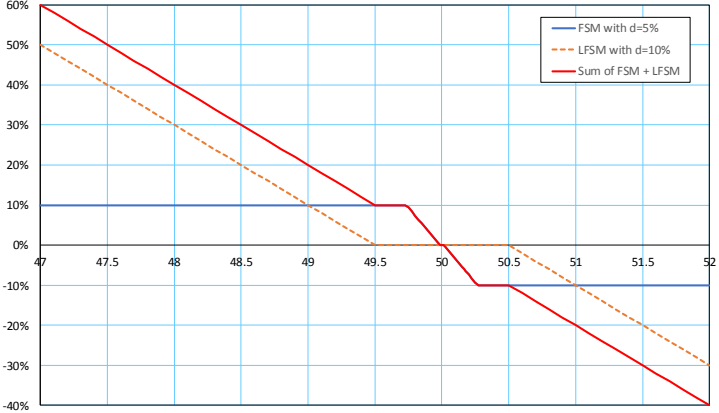
Response	Q1: Do you believe GC0101 better facilitates the Applicable Grid Code Objectives? Please include your reasoning	Q2: Do you support the proposed implementation approach? If not, please provide reasoning why.	Q3: Do you have any other comments?
<i>West</i>			
<i>Alastair Frew, Scottish Power Generation</i>	Yes and it implements European Law	Yes	No
<i>Andrejs Svalovs, GE Power</i>	Yes, for the national implementation of the Connection Codes	Yes	<p>In regards to the Type C and D, a cumulative operation of FSM and LFSM-O(-U) would be clarified.</p> <p>An example of the minimum requirements for a combined operation of FSM and both LFSMs over the full GB frequency range would be useful. Our interpretation below:</p>  <p>If this interpretation is correct, there is a frequency range when no any further change of the output is expected (e.g. 49.3-</p>

Response	Q1: Do you believe GC0101 better facilitates the Applicable Grid Code Objectives? Please include your reasoning	Q2: Do you support the proposed implementation approach? If not, please provide reasoning why.	Q3: Do you have any other comments?
			<p>45.5 Hz), the output stays flat. Would be useful to clarify if these flat regions are definitive requirements, or a continuation of the governor response will be acceptable.</p> <p>An example would show responses above the minimum line, still being acceptable. For example, an existing GB-FSM looks to be above the minimum cumulative requirements of ECC-FSM plus ECC-LFSMU, thus satisfying the ECC.6.3.7.3.2 together with ECC.6.3.7.3.</p> <p>Considering the minimal requirements can be surpassed, another workaround would be not to limit the power change to +/-10% but to change the droop at the respective frequency deviations to 10%. This would then correspond to a change of the onset frequencies of the LFSM-U and LFSM-O to values closer to the nominal frequency (but only for FSM on).</p> <p>Reference to Pmax in ECC.6.3.7.3.3  In regards to the Combined Cycle Power Plant, a reference to Pmax is not absolutely clear, as the CC output depends on the ambient conditions. Please clarify if this effectively refers to the output at the coldest day, or the current / typical ambient conditions would apply in defining the Maximum Capacity.</p>
Dr. Isaac Gutierrez,	Yes	No, timescales for	No



Response	Q1: Do you believe GC0101 better facilitates the Applicable Grid Code Objectives? Please include your reasoning	Q2: Do you support the proposed implementation approach? If not, please provide reasoning why.	Q3: Do you have any other comments?
<i>Scottish Power Renewable Ltd</i>		implementation of the modifications are being rushed and a grace period shall be implemented so developers that are in contract negotiations with manufacturer of generating equipment now are not penalised later with additional cost in order to meet the new Grid Code requirements.	
<i>Dr. Tim Ellingham, RWE Generation UK</i>	Please refer to response below		
<i>Paul Youngman, Drax Power Ltd</i>	Yes it satisfies objective (iv) to the extent that it introduces into the Grid code the requirements of European Network codes, and is therefore better than the baseline. The modification can also be seen as enabling aspects of Objective (i) and (iii) relating to the efficient maintenance and operation of the system and enhancing aspects of security of supply.	Yes	No comment
<i>Alan Creighton, Northern Powergrid</i>	Our comments relate generally to GC0100, GC0101 & GC0102. We believe that the Original proposals better facilitate the Gcode objectives (i), (ii) and (iii) as they facilitate the implementation of the EU RfG network code in an open and transparent manner.	Yes	We have two observations related to the draft code changes: <b>Glossary and Definitions</b> included as GC0100. There are some changes which are DCC related rather than RfG related; it is inappropriate to include these in a RfG focussed change. Of particular concern is the definition of a GB

Response	Q1: Do you believe GC0101 better facilitates the Applicable Grid Code Objectives? Please include your reasoning	Q2: Do you support the proposed implementation approach? If not, please provide reasoning why.	Q3: Do you have any other comments?
			<p>Code User.</p> <p>The proposed definition of a GB Code User c) A <b>Network Operator</b> or <b>Non Embedded Customer</b> whose <b>Main Plant and Apparatus</b> was connected to the <b>System</b> before 7 September 2018 or who had placed <b>Purchase Contracts</b> for its <b>Main Plant and Apparatus</b> before 7 September 2018 or has not <b>Substantially Modified</b> their <b>Plant and Apparatus</b> after 7 September 2018. Should be changed to:  c) A <b>Network Operator</b> or <b>Non Embedded Customer. DRC.</b>  Schedule 11 page 68 is unclear whether DNOs are required to report the number of Generation Units or PGMs installed at a Power Station.</p>
<i>Rob Wilson, NGET</i>	<p>National Grid as the GB SO supports the original proposal to which no alternative was progressed by the workgroup.</p> <p>Note that the choice of fault ride through parameters in GC0101 (specifically the post-fault retained voltage) led to the need to demarcate between smaller diesel plant and larger gas turbines to avoid compromising a class of generator while also maintaining operational support, and hence to the need for a B/C threshold of 10MW as in the original proposal for GC0100.</p>	Yes	No

Response	Q1: Do you believe GC0101 better facilitates the Applicable Grid Code Objectives? Please include your reasoning	Q2: Do you support the proposed implementation approach? If not, please provide reasoning why.	Q3: Do you have any other comments?
	<p>An assessment of the original proposal against the Grid Code objectives is as follows:</p> <p><i>i. To permit the development, maintenance and operation of an efficient, coordinated and economical system for the transmission of electricity</i></p> <p>Positive. In developing this code modification the task of the workgroup has been to find a balance between the costs that will be incurred by owners of equipment in complying with a more onerous specification and the benefit to the system in avoiding operational costs that would otherwise be incurred in providing support due to the connection of less capable equipment. This is also the aim of the European Network Codes as stated by ENTSO-E and is particularly important given the development of the system and the shift in the generation portfolio from larger, centrally despatched units to smaller and embedded renewable generation.</p> <p><i>ii. To facilitate competition in the generation and supply of electricity (and without limiting the foregoing, to facilitate the national electricity</i></p>		

Response	Q1: Do you believe GC0101 better facilitates the Applicable Grid Code Objectives? Please include your reasoning	Q2: Do you support the proposed implementation approach? If not, please provide reasoning why.	Q3: Do you have any other comments?
	<p><i>transmission system being made available to persons authorised to supply or generate electricity on terms which neither prevent nor restrict competition in the supply or generation of electricity)</i></p> <p>Positive. Ofgem have made clear during the workgroup proceedings that their decisions will be based on evidence in both directions – ie that where choices are made these are based on a tipping point being reached where the costs of choosing more onerous settings is evidenced to outweigh the operational benefit. Evidence supporting the National Grid proposal is provided in the report.</p> <p><i>iii. Subject to sub-paragraphs (i) and (ii), to promote the security and efficiency of the electricity generation, transmission and distribution systems in the national electricity transmission system operator area taken as a whole</i></p> <p>Positive, as stated above, in making balanced choices for the overall benefit of the end consumer.</p> <p><i>iv. To efficiently discharge the obligations imposed upon the licensee by this license and to</i></p>		

Response	Q1: Do you believe GC0101 better facilitates the Applicable Grid Code Objectives? Please include your reasoning	Q2: Do you support the proposed implementation approach? If not, please provide reasoning why.	Q3: Do you have any other comments?
	<p><i>comply with the Electricity Regulation and any relevant legally binding decisions of the European Commission and/or the Agency; and</i></p> <p>Positive. This modification is required to implement elements of the 3 European Connection Codes forming part of the suite of European Network Codes resulting from the EU 3rd Package legislation (EC 714/2009).</p> <p><i>v. To promote efficiency in the implementation and administration of the Grid Code arrangements</i></p> <p>Neutral.</p> <p>So as noted above, the GC0101 original proposal better facilitates objectives (i)-(iv) and is neutral against objective (v).</p>		

RWE Full response:

<p><b>1. Do you believe GC0101 better facilitates the Applicable Grid Code Objectives? Please include your reasoning</b></p>
<p>Not in its current form, please see the next section.</p>

## 2. Do you support the proposed implementation approach? If not, please provide reasoning why.

### Context:

This proposal seeks to modify the Grid Code to comply with the obligations in the EU Connection Codes:

1. Set the Voltage & Reactive requirement in GB, as required in RfG; and HVDC; and
2. Set the Frequency requirements in GB, as required in RfG and HVDC

RWE believes that on the grounds of inconsistency and onerous requirements; this code cannot be fully appraised on implementation approach. Specifically, RWE believes that the following clauses require significant review and amendment prior to the code entering into UK legislation.

### Operation above Rated MW

Removal of clause CC.6.3.2 a) i) constitutes a significant modification to the Grid Code:

- which is not mandated by the EU Regulation
- which is more onerous than the current grid code
- and which is therefore beyond the scope of the changes permitted within this Code Modification, therefore requiring independent consultation and review.

Grid code objectives include: *“to facilitate competition in the generation and supply of electricity...”* and *“...to promote the security and efficiency of the electricity generation...”*.

Due to the impact removal of this clause will have on asset efficiency and capability, it is RWE’s belief that this modification is in opposition to these objectives, where these are considered in the full context of the Grid Code Objectives.

Dependant on the enduring definitions (and including the current proposed definitions) of **“GB / EU Code User”**, removal of this clause is potentially life limiting for existing Onshore Synchronous Generation assets, for which modification or upgrade is an option. There is also a significant impact on commercial expectations and business planning for new Onshore Synchronous Generation assets, as the as the main plant and apparatus must either be overrated, or some MW capability sacrificed.

Further, in previous bilateral communications with the implementation team, no satisfactory response has been provided as to why clause CC.6.3.2 a) i) cannot be translated into the European Connection Conditions. Reference was made to conversion between current Stator Terminal reactive capability definition to a Grid Entry Point definition, but there is no justification for why clause CC.6.3.2 a) i) cannot also be translated in this manner.

Based on the above, a power factor option for Onshore Synchronous Power Generating Modules operating above Rated MWs (Maximum Capacity) should be included, using the same transposition method as was used to convert 0.95/0.85 to +/-0.92pf.

For reference CC.6.3.2 a):

In addition to the above paragraph, where **Onshore Synchronous Generating Unit(s)**:

- (i) have a **Connection Entry Capacity** which has been increased above **Rated MW** (or the **Connection Entry Capacity** of the **CCGT module** has increased above the sum of the **Rated MW** of the **Generating Units** comprising the **CCGT module**), and such increase takes effect after 1<sup>st</sup> May 2009, the minimum lagging **Reactive Power** capability at the terminals of the **Onshore Synchronous Generating Unit(s)** must be 0.9 **Power Factor** at all **Active Power** output levels in excess of **Rated MW**. Further, the **User** shall comply with the provisions of and any instructions given pursuant to BC1.8 and the relevant **Bilateral Agreement**; or
- (ii) have a **Connection Entry Capacity** in excess of **Rated MW** (or the **Connection Entry Capacity** of the **CCGT module** exceeds the sum of **Rated MW** of the **Generating Units** comprising the **CCGT module**) and a **Completion Date** before 1<sup>st</sup> May 2009, alternative provisions relating to **Reactive Power** capability may be specified in the **Bilateral Agreement** and where this is the case such provisions must be complied with.

For clarity, an example is outlined below to highlight the impact on generators:

Generator A (GB Code User) has a rating of 500MVA and an auxiliary load of 10MW.

- Rated MW at 0.85p.f. equates to 425MW
- Operation above Rated MW at 0.9p.f. equates to 450MW
- Declared Registered Capacity is therefore 440MW

Generator B (EU Code User) has a rating of 500MVA and an auxiliary load of 10MW.

- Maximum Capacity at 0.92p.f. equates to 0.85p.f. (Rated MW) on the generator terminals
- Maximum Capacity is therefore 415MW (taking into account auxiliary load)

Therefore a EU Code generator would have a **25MW** deficit compared to a GB Code generator in this example.

This is not as significant an issue for new generators, who can over-specify their generator rating, however this has an impact on GB Code Users' who may find themselves redefined as an EU Code User. That said, over-specification of assets is also not in the spirit of efficient & economic generation.

### Simultaneous V & F Requirement

We acknowledge that Article 16.2(a)(ii) of the RfG enables National Grid to write in the requirement for operation under simultaneous voltage and frequency events, however we are unhappy with the final legal text in ECC.6.3.13.5.

Our interpretation is that to avoid having to over-specify plant in order to cope with the extreme events, we would need to request permission from National Grid in order to install protection suitable for protecting our plant from damage due to operation outside of their design parameters.

This request is not in the spirit of fair competition and Code transparency, this could result in generators all having individual operating points with settings dependant on how well they negotiate terms with National Grid.

Our preference would be the continued allowance for generators to specify appropriate protection for their plant, however if National Grid feel that they need to specify a minimum requirement, then they should refer to appropriate electrical equipment standards and set limits according to those which the plant has been constructed to.

### 3. Do you have any other comments?

None



## 10. Grid Code Panel Views

Eleven responses were received to the Code Administrator Consultation which closed on the 2 February 2018. The Code Administrator highlighted that there were some responses that should be analysed ahead of the Recommendation Vote taking place. These are summarised below with the corresponding actions. Please note that the presentations presented to the Grid Code Panel can be found at the following link:

<https://www.nationalgrid.com/uk/electricity/codes/grid-code/meetings/special-gc-panel-meeting-dfmrs-mod-areas>

The presentation provided by NGET was provided to assist in facilitating the discussions following the feedback provided in the Code Administrator Consultation. The views from all Panel members were sought within the meeting in order to progress the modifications whilst using the Governance Rules outlined within this section of the Final Modification Report.

### **AMPS/ADE – possible defect for type B PGMs in FSM/LFSM-O spec & testing**

The full GC0101 response can be located in Annex 10.

The Panel agreed that the legal text that had been provided ensured that the UK would be compliant and fulfilled the requirement for this piece of work ahead of submission of the Final Modification Report to the Authority.

*(iii) if a change is not required after consideration, the **Panel Chairman** will undertake the **Grid Code Review Panel Recommendation Vote**.*

The Panel directed the Code Administrator to add the potential defect to the next Grid Code Development Forum to ascertain whether a modification to the Grid Code is required and if so make a decision as to how and when the modification would be raised.

### **RWE – removal of paragraph on revised reactive range above rated output, simultaneous voltage/frequency excursion ride-through requirements**

The full response can be located in Annex 10. The respondent highlighted some areas of the text where they were not happy with the proposed legal text.

The Panel, after consideration decided that this legal text did not require any further amendments ahead of submission to the Authority as per the Governance Rule below:

(iii)if a change is not required after consideration, the **Panel Chairman** will undertake the **Grid Code Review Panel Recommendation Vote**.

*For reference:*

## **Full Governance Rules after Code Administrator Consultation**

GR.22.4

A draft of the **Grid Code Modification Report** shall be tabled at the **Panel Meeting** prior to submission of that **Grid Code Modification Report** to the **Authority** as set in accordance with the timetable established pursuant to GR.19.1 at which the Panel may consider any minor changes to the legal drafting and:

(i)if the change required is a typographical error the Grid Code Review Panel may instruct the **Code Administrator** to make the appropriate change and the **Panel Chairman** will undertake the **Grid Code Review Panel Recommendation Vote**;  
or

(ii) if the change required is not considered to be a typographical error then the **Grid Code Review Panel** may direct the **Workgroup** to review the change. If the Workgroup unanimously agree that the change is minor the **Grid Code Review Panel** may instruct the **Code Administrator** to make the appropriate change and the **Panel Chairman** will undertake the **Grid Code Review Panel Recommendation Vote** otherwise the **Code Administrator** shall issue the **Grid Code Modification Proposal** for further **Code Administrator** consultation after which the **Panel Chairman** will undertake the **Grid Code Review Panel Recommendation Vote**.

Following the discussions held above, at the Grid Code Panel meeting on 8 February 2018, the Panel voted on GC0101 against the Grid Code Objectives.

The Panel members unanimously agreed that the Original was better than the baseline and recommended that it should be implemented.

Robert Longden was not in attendance at this meeting and did not pass his vote to another Panel member therefore his voting preferences were not included within this vote.

For reference the Grid Code Objectives are;

i.to permit the development, maintenance and operation of an efficient, coordinated and economical system for the transmission of electricity;
--

ii.to facilitate competition in the generation and supply of electricity (and without limiting the foregoing, to facilitate the national electricity transmission system being made available to persons authorised to supply or generate electricity on terms which neither prevent nor restrict competition in the supply or generation of electricity);
--

iii.subject to sub-paragraphs (i) and (ii), to promote the security and efficiency of the electricity generation, transmission and distribution systems in the national electricity transmission system operator area taken as a whole;
iv.to efficiently discharge the obligations imposed upon the licensee by this license and to comply with the Electricity Regulation and any relevant legally binding decisions of the European Commission and/or the Agency; and
v.to promote efficiency in the implementation and administration of the Grid Code arrangements.

Panel Member	Better facilitates (i)?	Better facilitates (ii)?	Better facilitates (iii)?	Better facilitates (iv)?	Better facilitates (v)	Overall (Y/N)
Guy Nicholson (Sigrid Bolik Alternate for the meeting)						
Original	No	Yes	Yes	Yes	Yes	Yes
<b>Voting Statement: None</b>						
Damian Jackman						
Original	Yes	Neutral	Yes	Yes	Yes	Yes
<b>Voting Statement: None</b>						
Robert Longden						
Was not present at the meeting so was unable to vote						
Alastair Frew						
Original	Neutral	Neutral	Neutral	Yes	Neutral	Yes
<b>Voting Statement:</b> This implements EU regulations						
Graeme Vincent						
Original	Yes	Neutral	Yes	Yes	Neutral	Yes
<b>Voting Statement:</b> The original is better than the baseline as it implements the requirements of the EU networks Code (RfG)						
Steve Cox						
Original	Yes	Yes	Yes	Yes	No	Yes
<b>Voting Statement: None</b>						
Alan Creighton						
Original	Yes	Yes	Yes	Yes	No	Yes
<b>Voting Statement::</b> The Original a better facilitates the objectives than the baseline in that it implements the EU RfG Network Code, promotes competition in that it harmonise generation plant requirements and hence help improve overall efficiency.						
Kyla Berry (Rob Wilson Alternate for the meeting)						
Original	Yes	Yes	Yes	Yes	Neutral	Yes
<b>Voting Statement:</b> Please see National Grid position at the start of the Report.						
Kate Dooley						
Original	Neutral	Neutral	Neutral	Yes	Neutral	Yes
<b>Voting statement.</b> The Original proposal best facilitates the applicable objectives.						

**Vote 2 – Which option is the best?**

Panel Member	BEST Option?
Guy Nicholson	Original
Damian Jackman	Original
Robert Longden	Not present at meeting no vote recorded
Alastair Frew	Original
Graeme Vincent	Original
Steve Cox	Original
Alan Creighton	Original
Kyla Berry	Original
Kate Dooley	Original

## References

[1] GC0048 Voltage / Reactive Consultation – Available at:-

<https://www.nationalgrid.com/uk/electricity/codes/grid-code/modifications/gc0048-joint-gcrp-dcrp-workgroup-gb-application-rfq>

[2] GC0087 Requirements for Generators Frequency Provisions – Available at:

<https://www.nationalgrid.com/uk/electricity/codes/grid-code/modifications/gc0087-requirements-generators-frequency-provisions>

## Annex 1 – Grid Code legal text

The legal text supporting this consultation comprises an extract of the new European Connection Conditions (ECC) section relating only to the material covered in GC0101. The remainder of this section is covered in GC0100 and GC0102. For information only, the full ECC section is also provided.

## Annex 2 – Terms of Reference

## Annex 3 – Workgroup Consultation responses

## Annex 4 – GC0048 Voltage & Reactive; GC0087 RfG Frequency Consultation Responses

### GC0048 Voltage / Reactive Consultation Responses

	RESPONDENT	COMMENTS	NATIONAL GRID RESPONSE
1	<b>EDF ENERGY</b>	<b>Supportive</b> Notes Banding is still an issue but agrees this will be addressed by separate consultation	Comments on Banding noted which will be picked up via a separate consultation
2	<b>UK PN</b>	<b>Supportive</b> Concerned over omitting Reactive Power and Power Factor Control from Band C requirements if the lower Banding Threshold (B/C – 10MW) is selected. These requirements should be stipulated in the codes rather than via bespoke connection arrangements Suggests overall co-ordination (especially G99/G98) with other EU codes before a final decision is made.	It is recognised that the default requirement is voltage control for Type C Power Generating Modules (both Synchronous and Power Park Modules). The current drafting under ECC.6.3.8.3.4 does permit Reactive Power or Power Factor control though this does refer to the Connection Agreement. We do not believe anything is omitted from Band C irrespective of where the boundary is. Agree that overall co-ordination (G99/G98) is required before a final decision is made
3	<b>AMPS</b>	<b>Supportive</b> Wider issues on fault ride through and banding will be addressed via separate consultation	Comments on Banding and fault ride through noted which will be picked up via a separate consultation.
4	<b>SSE Generation</b>	<b>Supportive</b> Do not believe that Reactive Power Control can be justified for Type B Generators Requirements are dependent upon Banding – particularly Band B/C. If the lower banding threshold is selected (B/C – 10MW) it is harder to see the justification for the same excitation performance requirements as a large directly connected 660MW Generator	Under the Grid Code, the default performance requirement would be voltage control. For DNO connected Generators, it is expected that voltage control or Power Factor control would be the most likely, with few cases emerging where Reactive Power Control would be likely. For Band C Generators there are some simplifications that can be made to the performance of the excitation system – for example the removal of the need for a Power System Stabiliser which it is acknowledged could add significant cost to the commissioning of the plant. This change will be made to the legal text. In terms of

			<p>lower spec excitation systems for Type C Synchronous Power Generating Modules, it is believed there is flexibility in the current drafting to permit low spec excitation systems –eg a rotating excitation system rather than static. We will however look at this section to see what further simplifications can be made.</p>
5	<b>DONG Energy</b>	<p><b>Supportive other than in respect of Offshore Connections</b></p> <p>Significant concerns over the interpretation of the voltage / reactive capability for Offshore wind farms (particularly configuration 1)</p> <p>Not comfortable with the use of a Commercial Agreement. Would prefer the use of a Bilateral Arrangement as currently drafted in the GB Code in addition to a Cost Benefit Analysis.</p>	<p>Having re-examined RfG, the Offshore Connection Point of an AC Connected Offshore Power Park Module shall be defined by the Relevant System Operator. The current Grid Code (Under the Offshore Transmission Regime)- states this can be any point between the HV and LV side of the Offshore Platform so it should be possible this could be accommodated going forward.</p> <p>Art 25(5) states that for a Configuration 1 Offshore wind farm the maximum Q/Pmax value is 0 (ie unity power factor). Art 21(3)(b) states the U-Q/Pmax profile shall not exceed the U-Q/Pmax profile represented by the inner envelope of Figure 8 and the dimensions of the U-Q/Pmax profile (Q/Pmax range and voltage range) shall be within the values specified for each synchronous area (ie Table 11 for Offshore Power Park Modules) – The wording in RfG is unclear, as it implies that a wider range cannot exceed the maximum in Table 11. We agree that this value is unduly restrictive as highlighted in section 10.17 of the consultation document.</p> <p>We fully agree with your response in relation to this issue as we see no reason why a wider capability could not be accommodated especially as there are significant benefits to utilizing the capability of the turbines. We will seek clarity on this issue with ENTSO-E and if they are agreeable to our proposal, one option would be to require Configuration 1 AC connected Offshore wind farms to meet the minimum requirements of Art25(5) but that would not preclude them from satisfying a wider reactive capability range if agreed between the OFTO, Offshore Generator and National Grid This approach would remove any reference or need for a Commercial Agreement and would bring the proposal more in line with current GB</p>

			<p>Grid Code practice the approach for a wider range as agreed between all parties would be subject to a positive cost benefit analysis.</p> <p>In terms of reactive capability, it is assumed that the reactive capability requirements would be specified at the Offshore Grid Entry Point although we recognise the flexibility under Article 21(3)(a) of RfG.</p> <p>Pending the response of ENTSO-E it is proposed the legal text is updated to reflect the above comments.</p>
6	<b>ScottishPower Renewables</b>	<p><b>Supportive</b></p> <p>SPR disagree on Question (vi) that historically the requirements in the Distribution Code are generally less onerous than those in Grid Code making distribution connections cheaper</p>	<p>For Type C and D Power Generating Modules there should be little difference between the reactive capability and control performance requirements between Distribution and Transmission Connected Generators. That said it is acknowledged that RfG gives little guidance in respect of the excitation performance requirements for Type C Synchronous Power Generating Modules. The current proposal is for Type C Synchronous Power Generating Modules to have the same requirements as Type D Synchronous Power Generating Modules, although based on the comments from this consultation, a suggestion would be for Type C Synchronous Power Generating Modules not to be required to have a Power System Stabiliser.</p> <p>For Type C and D Power Park Modules the control system specification (ie voltage control, power factor control or reactive power control) would be at the discretion of the System Operator (in co-ordination with the relevant TSO. Since the Relevant System Operator could be the Transmission System Operator or Distribution Network Operator then it is possible that the requirements could be different between the Transmission or Distribution System.</p> <p>For Type B Generators , RfG is very vague leaving the requirements for Excitation and control performance to the discretion of the Relevant System Operator (ie the</p>

			Transmission System Operator or Distribution Network Operator). It is acknowledged that at a site specific level, the Distribution connection requirements could be less onerous than the Transmission connection requirements however it needs to be re-emphasised that so far as RfG is concerned, they are the same.
7	RWE	<b>Not Supportive unless detailed comments are addressed</b>	
		Definition of Performance chart at the terminals and at the Connection Point	Agreed – Text will be updated to make this more explicit
		ECC.6.3.2.4 – Minimum Generation should be used rather than DMOL	We think it may be better to retain the existing GB definition of DMOL. We recognise that RfG uses the term “Minimum Regulating Level” but to maintain consistency and avoid over complexity in the code (as the term DMOL) is still likely to be used going forward, we feel it would be better to retain the GB term. DMOL is the output below which a Genset or DC Converter has no high frequency response capability. Minimum Regulating level is specified in the connection agreement down to which the power generating module can control active power. In summary it may be required to change the definition of DMOL to include elements of minimum regulating level but we will continue to review this.
		ECC.6.1.4 – 400kV operating range -5% to +10%. This needs to be made consistent with Art 16(2)	Agreed – the text will be updated to ensure consistency with RfG.
		Figures X3 – X6 - Q/Pmax is used rather than Power Factor. The Grid Code should contain one consistent term throughout	Agreed – Text will be updated to make this more explicit



	Rated MW is not an RfG term and should be replaced by Maximum Capacity	It is acknowledged that Maximum Capacity (in the majority of cases) is the correct term from a connections requirement perspective, though a consistency check needs to be made to ensure that the correct terms have been used in the legal text. However the term Rated MW will still be required largely for data submission purposes.
	The new drafting makes no reference to reactive capability above Rated MW which is currently covered in the existing GB Code	Under RfG, the reactive capability requirement is at the Connection Point not at the terminals of the alternator. The reactive capability is therefore a function of Maximum Capacity which are both quantities with respect to the Connection Point. We therefore believe that operation above Rated MW is not relevant in an RfG world.
	ECC.6.3.4.1 – Concern that changes to ECC.6.1.4 make the requirement to maintain constant Active Power more demanding	This is largely a copy of the existing GB Grid Code text as is ECC.6.1.4 so it is unclear why this requirement would be more onerous. Under the current GB Grid Code, the requirement for voltage range defined under CC.6.1.4 states the 400kV voltage will normally remain within $\pm 5\%$ unless abnormal conditions prevail. The minimum voltage is -10% and the maximum voltage is +10% unless abnormal conditions prevail, but voltages between +5% and +10% will not last longer than 15 minutes unless abnormal conditions prevail.
	ECC.6.3.8.3.3 – Maximum upper limit on terminal voltage to be specified.	This is largely a copy of the existing GB Grid Code text which was introduced following Grid Code consultation GC0028. At that time no maximum limit was placed on terminal voltage as it was felt that this value would be determined by the Generator in the interests of protecting their Plant and Apparatus. It is however a data value required to be submitted by Generators under PC.A.5.3.2(a).

		ECC.6.3.12.1.1 – Concerns over combines voltage / frequency ranges and the costs to which Generators could be exposed.	This issue was previously raised as part of Grid Code Consultation D/10 (Frequency and Voltage operating ranges). It is not clear that RfG changes this position. In fact it is probably worth noting that this clause introduces greater flexibility than in the current GB Grid Code.
		Concern that a PSS is required for Type C Synchronous Power Generating Modules	We agree with this comment. For Type C Synchronous Power Generating Modules we would not mandate the need for a Power System Stabiliser, however we do need to ensure that any Synchronous Generating Unit connected to the Network displays an adequate level of damping so we can comply with the requirements of the SQSS.
		Voltage control preferred for Type B Generators. Recognised that there may be many transformation levels between a Type B Generator connected to an industrial network and the transmission network or a Type B Generator connected directly to the Transmission System	Point noted
8	<b>SP Energy Networks</b>	<b>Supportive</b> Banding needs to be addressed Voltage / Reactive Requirements need to be assessed by the SO and DNO on a site specific basis Noted that there are and will be numerous connections in Scotland at 33kV which are Transmission connected. Need to fully review the glossary and definitions to ensure consistency across the codes.	Banding will be addressed via a separate consultation which will need to take a number of technical issues (including voltage / reactive into account). As far as RfG is concerned, the requirements for reactive capability and control are the same however it is noted that the detailed performance requirements will need to vary depending on connection point, topology and Network operator requirements. Typographical errors noted in Para 8.16, and that there will be cases of direct connections at 33kV.  A full review of all the definitions will need to be undertaken when all the EU code mods are more advanced.

9	<b>NPG</b>	<p><b>Supportive</b></p> <p>If the lower Banding threshold (10MW) is selected, should Type C be included in G99</p> <p>Definitions need to be consistent across the Codes</p> <p>ECC.6.1.4 – 132kV is not a Transmission Voltage in England and Wales – clarification of 110kV required</p> <p>ECC.6.3.1.1 – The Grid Code needs to be clear that for any plant which is embedded the requirements of the Distribution Code would also apply</p> <p>ECC.6.3.2.6.2 3&amp;4 – Confusion between the way in which reactive power is defined</p> <p>Comments on G99 drafting – ECC.6.3.8.1&amp;2/ECC.A.7.3&amp;4 – If Type B Generators are independent of whether they are distribution or transmission connected should the text be replicated in G99</p> <p>Oc2.4.2- G99 to consider the need for an operating chart at the alternator terminals and connection point</p>	<p>See last paragraph below</p> <p>ECC.6.1.4 is largely a direct lift from the GB Grid Code which includes voltages less than 132kV. In addition there will be cases where TO's own network less than 132kV so the Grid Code will need to cover these aspects.</p> <p>ECC.6.3.1.1 – Agreed – the text will be updated to address this issue.</p> <p>ECC.6.3.2.6.2 3&amp;4 - Agreed – the text will be updated to address this issue.</p> <p>The working assumption is that embedded Type C and D will be coded in the Grid Code with a reference to that from the D Code. However this needs a thorough debate when the implications of this become clearer. It is proposed for the time being to carry on on this route, and when the drafting is fairly complete, and all the obligations etc clearly laid out in drafting, it will be easier to see how proposals to put Type C obligations in the D Code will work, and being able to be sure that the complete implications are observable.</p>
10	<b>Siemens</b>	<p><b>Supportive other than in respect of Offshore Connections</b></p> <p>Significant concerns over the interpretation of the voltage / reactive capability for Offshore wind farms. Not comfortable with the use of a Commercial Agreement. Would prefer the use of the flexibility as currently drafted in the GB Code plus a Cost Benefit Analysis.</p>	<p>Similar issues as per item 5 above –DONG Energy</p>
11	<b>SSEN</b>	<p><b>Supportive</b></p> <p>Comments noted on Banding</p> <p>G99 Comments – 50kW Split between G99 and G98 however a better solution may be to have a boundary at the connection</p>	<p>Any Report to the Authority or revised consultation document would need to highlight the following points:-</p> <p>Banding is still unclear</p> <p>The large volumes of embedded generation initially seen in Scotland now apply</p>

		<p>voltage (ie the LV connection with an upper limit of 1MW matching the requirements in RfG.</p> <p>How will a power station comprising synchronous and asynchronous generators be dealt with</p>	<p>across large parts of England and Wales. A regional variation in Scotland is therefore not applicable.</p> <p>Appropriate control (eg voltage control, reactive power control, or Power Factor control) already apply to Type B Synchronous Generators and to some Type A Power Generating Modules (ie both Synchronous and Asynchronous)</p> <p>Split Band A - Consideration to be given to splitting the documentation – For further consideration in the near future.</p> <p>Operational aspects of G98 and G99 will need to be considered in the fullness of time but this issue can be dealt with in the future.</p> <p>How would a power station be treated which comprised of synchronous and asynchronous units. An example of this could be included in the Report to the Authority.</p>
12	<b>ScottishPower Generation</b>	<p><b>Supportive</b></p> <p>Concern over definitions in particular physical quantities such as current, voltage etc</p>	<p>In developing the Grid Code legal text, it has been assumed that we will retain GB definitions where possible and only use European definitions where there is a need to do so. The issue of physical quantities was raised on a number of occasions and that a pragmatic approach developed.</p> <p>The principle adopted is that physical quantities such as voltage and current are not defined in the GB Grid Code. It is proposed that this approach is retained so that when terms such as voltage and current are used in the GB code they are not defined, the intention being that the term current or voltage is then used in the appropriate context.</p>

## GC0087 – RfG Frequency Consultation Responses

	RESPONDENT	COMMENTS	NATIONAL GRID RESPONSE
1	EDF ENERGY	<p><b>Supportive with the following note:</b>            We agree with the reasoning behind the value of 1 Hz/sec. to be set as a RoCoF Withstand capability limit, as per RFG Article 13.1 (b).            However, we would also expect an appropriate level of transparency and process to be in place governing the associated RoCoF Operational limit. The RoCoF Operational limit is an internal National Grid limit currently set at 0.125 Hz/sec.            We believe that it would be more appropriate for this limit to be included in the SQSS, where the Operational limit set value would be visible, and where there is a modification process in place.            Such an approach would be in line with other operational standards and, given the importance of the RoCoF issue and the fact that it is already an active operational consideration, would give the right emphasis to this key parameter.</p>	<p>National Grid does not believe a RoCoF limit specified within the SQSS is necessary or beneficial. The necessity of managing RoCoF arises from the requirement to ensure that there are no “Unacceptable Frequency Conditions” prior to any fault or following a secured event. Hence, NGET ensures that the RoCoF stays below the limit that would result in any loss of generation.            At the moment, NGET uses a RoCoF limit of 0.125Hz/s. This is dictated by the LoM protection settings of embedded generation. Once the settings of existing relays have all been revised to be 1Hz/s, NGET will work to the new limits. Exceeding these limits would result in large loss of infeed that the system is not likely to be able to cope with. Hence the value that NGET is required to manage RoCoF to is implicit.            If we set a RoCoF limit in the SQSS at the current 0.125Hz/s limit, then we have to manage RoCoF to that level even after revising the settings for all existing RoCoF.            If we set a RoCoF limit in the SQSS at the future 1Hz/s limit, then we would not be able to manage it to the 0.125Hz/s. This means that the RoCoF limits would contradict the frequency control limits.            The process of managing an SQSS modification to change RoCoF from 0.125Hz/s to 1Hz/s in coordination with the programme to revise the settings for all the relays would be challenging.            Hence, the view is that acceptable RoCoF limit is implicitly specified as the level that would not result in generation loss. This provides the flexibility required to be</p>

			<p>economic and efficient and is transparent.</p> <p>The RoCoF withstand limit was set at 1Hz/s for the purposes of informing manufacturers of the new design specification requirements.</p>
2	<p><b>Nordex</b></p>	<p><b>Supportive with the following exception</b></p> <p>Further clarification is sought on the proposed modifications to ECC6.3.7.3.1, ECC6.3.7.2.2 and ECC6.3.7.3.3 as this is contrary to industries understanding.</p> <p><b>ECC6.3.7.3.1</b> In addition to the requirements of <b>ECC6.3.7.1</b> and <b>ECC6.3.7.2</b> each <b>Type C</b> and <b>Type D Power Generating Module</b> must be fitted with a fast acting proportional <b>Frequency</b> control device (or turbine speed governor) and unit load controller or equivalent control device to provide <b>Frequency</b> response under normal operational conditions in accordance with <b>Balancing Code 3 (BC3)</b>. In the case of a <b>Power Park Module</b> the <b>Frequency</b> or speed control device(s) may be on the <b>Power Park Module</b> or on each individual <b>Power Park Unit</b> or be a combination of both. The <b>Frequency</b> control device(s) (or speed governor(s)) must be designed and operated to the appropriate:</p> <p>ECC6.3.7.2.2 (vi)</p>	<p>This section of code resulted from lengthy and vigorous negotiations between NG and the GB wind industry (including representatives from wind farm manufacturers) during the H/04 grid code modification process. This negotiated agreement resulted in freedom for wind farm operators and OEMs to choose central or power park unit based frequency response control systems.</p> <p>The existing grid code text ensures that as the number of PP Units in a PPM reduces, the duty required of the remaining PP Units does not increase. Many operators and OEMs would see this as an advantage.</p> <p>Many wind turbine manufacturers and wind farm controller suppliers have already produced systems which comply with the GB Grid Code which allows a reduction in response as the number of available PP Units reduces. Therefore a grid code amendment to address the challenges identified by Nordex could require modification to these systems and this would probably be unwelcome by many GB wind farm owners.</p> <p>Response to comment on ECC6.3.7.3.3. (vii), Current GB Grid Code does not define this.</p>

Active power-frequency response capability of power generating modules in LFSM-U

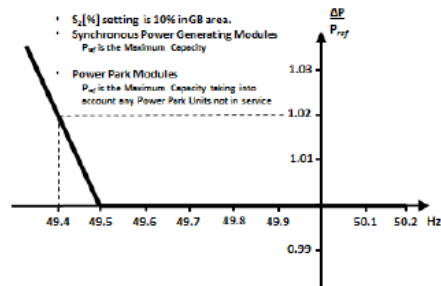

Figure X2 –  $P_{ref}$  is the reference **Active Power** to which  $\Delta P$  is related and may be specified differently for **Synchronous Power Generating Modules** and **Power Park Modules**.  $\Delta P$  is the change in **Active Power** output from the **Power Generating Module**.  $f_n$  is the nominal frequency (50Hz) in the network and  $\Delta f$  is the frequency deviation in the network. At underfrequencies where  $\Delta f$  is below  $\Delta f_1$  the **Power Generating Module** has to provide a positive **Active Power** output change according to droop  $S_2$  which shall be no greater than 10%.

The figure X2 has a small note stating that the response for a power park module is based upon the number of power park units in service.

**ECC.6.3.7.3.3** Type C and Type D Power Generating Modules shall also meet the following minimum requirements:

- (i) Power Generating Modules shall be capable of providing Active Power Frequency response in accordance with the performance characteristic shown in Figure X3 and parameters in Table X4.

Active power/frequency response capability of power generating modules is FRM:

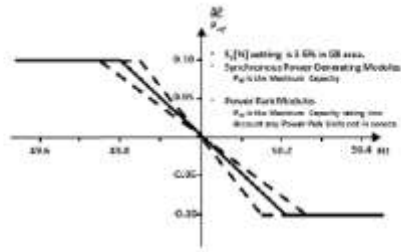

Figure X3 –  $P_{g0}$  is the reference Active Power to which  $\Delta P$  is related.  $\Delta P$  is the change in Active Power output from the Power Generating Module.  $F_0$  is the nominal Frequency (50Hz) in the System and  $\Delta f$  is the frequency deviation in the System. Figure X3 illustrates the case of zero Deadband and droopability.

- (ii) In satisfying the performance requirements specified in ECC.6.3.7.3(ii) Generators in respect of each Type C and Type D Power Generating Module should be aware:-

- in the case of overfrequency, the Active Power Frequency response is limited by the Minimum Regulating Level,

- in the case of underfrequency, the Active Power Frequency response is limited by the Registered Maximum Capacity,

the actual delivery of Active Power frequency response depends on the operating and ambient conditions of the Power Generating Module when this response is triggered, in particular limitations on operation near Maximum Capacity at low Frequencies as specified in ECC.6.3.3 and available primary energy sources.

The frequency control device (or speed governor) must also be capable of being set so that it operates with an overall speed Droop of between 3 – 5%. The deadband and droop must be able to be reselected repeatedly. For the avoidance of doubt, in the case of a Power Park Module the speed Droop should be equivalent of a fixed setting between 3% and 5% applied to each Power Park Unit in service.



	<p>The figure X3 has a small note stating that the response for a power park module is based upon the number of power park units in service.</p> <p>Windfarm manufacturers believed the windfarm operators and OEM's had the freedom to choose central or power park unit based frequency response (ECC6.3.7.3.1)</p> <p>With the advantage that a module approach would give the response based upon the available active power in the wind regardless of the unit available and not the number of WTG's in service.</p> <p>The unit approach enables the windfarm to decrease the power output when units are out of service.</p> <p>Now however it appears in the figures that there is no distinguishing between either approach. If it were treated as a module with a central controller the windfarm must de-rate the remaining available power to represent the loss of a unit in service.</p> <p>Finally The module approach has significant available capacity advantages over most of the operating range. Which would (with the Unit approach) have to be supplied by conventional or legacy generation, at extra cost. Surely there is a cost benefit advantage from the module</p>	
--	--	--

		<p>approach to National Grid, should it be available.</p> <p>Also one comment on ECC6.3.7.3.3. (vii)</p> <p>ECC.6.3.7.3.3</p> <p>(vii) Where a <b>Type C</b> or <b>Type D Power Generating Module</b> becomes isolated from the rest of the <b>Total System</b> but is still supplying <b>Customers</b>, the <b>Frequency</b> control device (or speed Governor) must also be able to control <b>System Frequency</b> below 52Hz unless this causes the <b>Type C</b> or <b>Type D Power Generating Module</b> to operate below its <b>Designed Minimum Operating Level</b> when it is possible that it may, as detailed in <b>BC 3.7.3</b>, trip after a time. For the avoidance of doubt the <b>Power Generating Module</b> is only required to operate within the <b>System Frequency</b> range 47 - 52 Hz as defined in <b>ECC6.1.3</b> and for converter based technologies, the remaining island contains sufficient fault level for effective commutation;</p> <p>The ESQ&amp;C (Electrical Safety, Quality and Continuity regulations 2002) in particular requires Islanded systems to be earthed at one point. The present text has no reference to this Statutory regulation. A reference to this should be included here for information.</p>	
3	<p><b>Britned</b></p>	<p><b>Unsupportive</b></p> <p>Based on the Grid Code drafting provided, it is difficult to understand how the impact on Interconnectors/DC Converters has been assessed at high. The Grid Code drafting is unclear and incomplete for DC Converters which makes assessment of the impacts impossible. Below are our comments</p> <p>Definitions</p>	<p>GC0087 was part of the EU Requirement for Generators and was not intended for HVDC connections, these were being covered under GC0090 workgroup. Both the RfG and HVDC Codes do not apply to existing Generators or HVDC Converters. An existing Generator/HVDC Converter is one which is already running / commissioning or has not let its contract for major plant items (eg turbine, Generator, converter equipment etc) from two years after Entry into force) of the Codes. For RfG the Entry into Force Date was 17<sup>th</sup> May 2016 and for HVDC the Entry into Force Date</p>

<ul style="list-style-type: none"> <li>• The proposed change to ‘Genset’ to include BM Participant means that it would capture DC Converters. This doesn’t appear to be the intention as ECC.6.3.1.2 indicates that requirements for DC Convertors are contained elsewhere. If the intention is to capture DC Converters with ‘Genset’ has the Grid Code been reviewed for the consequential impacts this definition change cause?</li> <li>• ‘HVDC Systems’ referred to in ECC.6.3.1.2 is not defined. How does this differ from DC Converters?</li> <li>• ‘Type A, Type B, Type C and Type D Power Generating Modules’ referred to in ECC.6.3.1.1 and throughout the drafting are not defined. It is assumed that DC Converters are not captured by any of these definitions (specifically Type D) but a definition that makes this clear would be useful.</li> </ul> <p>ECC.6.3.1.2</p> <ul style="list-style-type: none"> <li>• This clause is incomplete and makes it impossible to assess the impact on DC Converters.</li> </ul> <p>Applicability</p> <ul style="list-style-type: none"> <li>• Paragraphs 2.8 and 2.9 of the consultation indicate when these requirements will be applicable but the Grid Code text is unclear. A clearly identified date of when the requirements will be applicable is suggested as this clarifies any issues around retrospective application and enables parties to better understand</li> </ul>	<p>was 29<sup>th</sup> September 2016.  HVDC requirements have been included in GC0101 text.</p>
--	--

4	<b>Scottish Power Renewables</b>	<p><b>Supportive with the following comments</b></p> <p>1. Page 54 - ECC.6.3.X.1 is the input port receiving a digital or analogue signal? SPR believes that this type of technical considerations should be taken into account before including the input port requirement in the grid code. As an example there was widespread confusion on the Power available signal and to date transmission licensee as SPT does not include in the exchange signal list Power available</p> <p>2. Page 57- ECC.6.3.7.1.2 States the minimum droop requirement for LFSM-O shall be no greater than 10% SPR believes that as this is the minimum requirement there should be a clarification as if a droop between 3% to 5% (and any droop between 5% and 10%?) is acceptable as this can greatly simplify the frequency response controller logic</p> <p>3. Page 59 - ECC.6.3.7.2.1 The word “not mandatory” shall be included in the text of this clause for LFSM-U</p> <p>4. Page 59 - ECC.6.3.7.2.2. Same comment as item 2 above.</p> <p>5. Page 63 – Table X4. SPR believes that there should be a value of inertia that defines what generators are considered to not have inertia as some renewable energy generators could have very little inertia. Without a limit value of inertia the interpretation of generators without inertia is ambiguous otherwise a system with very low inertia can be considered compliant with an initial time delay of 2s?</p>	<ol style="list-style-type: none"> <li>1. This can be defined</li> <li>2. This can also be defined</li> <li>3. Disagree, this is an RfG requirement</li> <li>4. This can be defined</li> <li>5. Asynchronous generators or any generator connected via power electronic equipment are defined as not having inertia</li> </ol>

**Annex 5 – Remote end HVDC Converter Frequency Response parameters Title III**

**Annex 6 – HVDC Frequency Response Parameters Title II**

**Annex 7 – Mapping for Grid Code (and Distribution Code)**

**Annex 8 – DC Connected Power Park Modules Frequency Response parameters Title III**

**Annex 9 – Potential Alternative form – not formal alternative**

**Annex 10 – Code Administrator Consultation responses**