

# National Grid UK Electricity Transmission plc

Uncontrolled when printed



## NATIONAL SAFETY INSTRUCTION and Guidance

### NSI 6 DEMARCATIION IN SUBSTATIONS

Copyright National Grid plc 2016 ©, all rights reserved. No part of this publication may be reproduced, stored in a retrieval system, or transmitted in any form or by any means electronic, mechanical, photocopying, recording or otherwise, without the written permission of National Grid obtained from the issuing location.

The contents of National Grid documents are based on the needs of National Grid and the conditions under which it operates. It shall not therefore be assumed that the contents stated therein necessarily meet the particular circumstances and requirements of other organisations. The principles set out in this document are for information only and therefore National Grid is not liable to any third party for any loss or damage resulting from reliance on the contents. It is the responsibility of such external organisations to check that the document is the latest version and is appropriate for their purposes.

**DOCUMENT HISTORY**

Issue	Date	Summary of Changes / Reason	Author(s)	Approved By (Title)
1	20/11/2009	Formatted and re-drafted to follow 3 <sup>rd</sup> edition Electricity Safety Rules layout. Safety notes and safety bulletins	NSI Working Group	MDE Manager Les Adams 
2	04/04/2011	Annual review; document amended as detailed below and minor text changes as highlighted in yellow.	NSI Review Group	MDE Manager Les Adams 
3	April 2014	Renamed as "National Safety Instruction and Guidance" which now incorporates and replaces NSI 6 Issue 5.	NSI Review Group	ETAM Operations North Manager Mike Dean
4	April 2016	Annual review; document amended as detailed below and minor text changes as highlighted in yellow.	NSI Review Group	ETAM Operations North Manager Matt Staley

**KEY CHANGES**

Section	Amendments
5.4	Words changed to clarify GIS demarcation requirements.
4.1 Guidance & Appendix A	Deleted reference to 'Demarcation Risk Assessment Form' and Form in Appendix A replaced with 'Examples of NSI 6 Demarcation Drawing'

---

## DEMARCATIION IN SUBSTATIONS

### CONTENTS

	Page
1 Purpose and Scope	1
2 Definitions	2
3 Dangers	3
4 Risk Assessment	4
5 Demarcation of Work Areas	5
6 Demarcation of Risk Management Areas and General Hazard Zones	8
7 Roles and Responsibilities – Demarcated Work Areas	9
8 Roles and Responsibilities – Risk Management Areas and General Hazard Zones	10
9 Safety Rule Demarcation in a CDM Demarcated Area	11
Appendix	
A – Examples of NSI 6 Demarcation Drawing	12
B – Examples of Demarcation for Work Areas	13
B1 - Permit for Work	
B2 - Testing	
B3 - Limited Access Certificate	
B4 - Where a Natural Fence Already Exists	
B5 - SF <sub>6</sub> gas Insulated Switchgear	
B6 - Low Voltage	
B7 - Mechanical	
C – Examples of Demarcation for Risk Management and Hazard Zones	29
D – Examples of Safety Rule Demarcation in a CDM Area	32
D1 - Large CDM Area	
D2 - CDM Demarcation as part of the Safety Rule Demarcation	
D3 – Safety Rule Demarcation as part of the CDM Demarcation	
E – Safety Notices	35
F – Authorisation Matrix for Contractors Personnel	36

## 1 Purpose and Scope

To apply the principles established by the Safety Rules and provide guidance on National Safety Instruction 6, on the use and application of demarcation for work to achieve **Safety from the System** for personnel working on or near to **Equipment** in substations. This also includes *Risk Management Hazard Zone(s)* and general hazard zones to ensure safety.

There are two levels of authorisation to this NSI for a **Senior Authorised Person**, limited and full.

Limited authorisation roles and responsibilities are for:

- OHL **Senior Authorised Person** for demarcation of **HV Safety Document(s)**

Full authorisation roles and responsibilities are for:

- Substation **Senior Authorised Person** for demarcation of **HV, LV** and mechanical **Equipment**

The layout of this guidance note reflects that of legislative codes of practice, where the rule (or mandatory obligation) is identified by a green panel on the left-hand side. The guidance follows after the rule and is identified by a blue panel.

Within National Grid, guidance notes hold equivalent status of an Approved Code of Practice (ACOP) in law. If not followed, you will be required to demonstrate that your safe system of work is of an equal or higher standard.

## 2 Definitions

Terms printed in bold type are as defined in the Safety Rules.

<b>Title</b>	<b>Definition</b>
<i>Access Point Notice</i>	A notice defining access to and egress from a demarcated area
<i>Access Prohibition Notice</i>	A notice prohibiting access
<i>Danger Notice</i>	A notice which is attached to <b>Equipment</b> and structures to warn of electrical or mechanical <b>Danger(s)</b>
<i>Designated Gas Zone Access Point Notice</i>	A notice identifying all required access points to the gas zone which require venting prior to access in accordance with Management Procedure - NSI 10 "Equipment Containing Sulphur Hexafluoride (SF6)"
<i>Keep Clear Overhead Live Equipment Notice</i>	A notice warning about <b>Danger</b> from overhead <b>Live Equipment</b>
<i>Limited Access Certificate Notice</i>	A notice reading "LAC" in the form of blue sleeves
<i>Risk Management Hazard Zone</i>	An identified area where access is restricted from <b>Equipment</b> , which may have a defect and may have the potential to cause harm
<i>Risk Management Hazard Zone Notice</i>	A notice that is attached to a yellow and black chain demarcating a <i>Risk Management Hazard Zone</i>
<i>Testing Area No Entry Notice</i>	A notice prohibiting entry to the testing area unless under the <b>Personal Supervision</b> of the holder of the <b>Safety Document</b>
<i>Testing Notice</i>	A notice reading "Test Area" in the form of red sleeves
<i>Vented Gas Zone Access Point Notice</i>	A notice identifying all required access points to the gas zone which have been vented and can now be entered in accordance with Management Procedure - NSI 10 "Equipment Containing Sulphur Hexafluoride (SF6)"

### 3 Dangers

The **System Danger(s)** to **Personnel** arising out of inadequate demarcation in substations are electrocution, burns, impact from release of pressure and effects on eyes arising from:-

- The possibility of mistaking **Equipment** on which it is unsafe to work, from that which it is safe to work
- Inadvertently infringing **Safety Distance**
- Inadequate planning leading to a failure in the co-ordination of all work activities
- Failure to adequately control risks associated with Hazard Areas and Testing activities

**NSI 6**  
4.1

**4 Risk Assessment**

- 4.1 The **Senior Authorised Person** shall carry out a site specific written risk assessment taking into account the work to be undertaken to determine the most appropriate system for defining clear boundaries between safe and unsafe workplaces.

**Guidance**  
NSI 6  
4.1

**4 Risk Assessment**

- 4.1 Demarcation of a work area is a main control measure achieving **Safety from the System** by ensuring clear boundaries between safe and unsafe workplaces.

The **Senior Authorised Person** shall consider the following as part of their risk assessment:-

- Proximity to adjacent **Equipment**
- **Danger** which may arise from **Live Equipment** or **Equipment** which may become **Live** e.g. over sailing conductors
- The location and need for more than one designated access point including designated vehicle access point(s)
- The work area required. Is there adequate space for the proposed method of work, plant and / or equipment to be used?
- Forcing the work into the safest position e.g. farthest away from the **High Voltage (HV)** electricity
- Clear demarcation of the work/test area
- Nature of works e.g. maintenance, construction, refurbishment or testing etc.
- What are the unique considerations of the work?
- Is other work going on in the vicinity, if so consider the interface?
- CDM or other legislative requirements
- Relevant views expressed by the **Competent Person** and members of the **Working Party**
- The effects of the process e.g. smoke from a heating process
- Experience of those undertaking the work
- Where it has been identified that more than one Working Party is required in a single demarcated work area, consideration shall given to using multiple smaller demarcated work areas or staggered working arrangements. If this is not reasonably practicable then suitable co-ordination must be established prior to starting work and maintained throughout the work.

**NSI 6**  
5.1 to 5.3

## 5 Demarcation of Work Areas

5.1 Free standing demarcation shall be:-

- (a) Independently supported.
- (b) Not attached to any structure supporting **Equipment**.
- (c) Identified using the appropriate coloured cones placed at intervals not exceeding 6 metres, supporting plastic chain suspended more than 500 mm above ground level or by a rigid barrier.
- (d) Identified by green cones, with coloured sleeves if appropriate, placed 1 meter inside the work area at intervals not exceeding 6 meter.
- (e) Supplemented by a designated access point(s) consisting of two 1 metre high red cones with clear plastic sleeves displaying white lettering indicating "access / egress" directions. These cones should be a maximum width of 1 metre apart. An *Access Point Notice* shall be positioned adjacent to these cones. If no **Safety Document** recipient is on site, the "access / egress" point shall be closed prohibiting access.

5.2 Free standing demarcation is not required where a natural boundary, wall or fence exists. Green cones shall be placed at the entrance point and 5.1(e) shall be met.

5.3 Additional requirements to Section 5.1 and 5.2 for **Safety Document(s)** Demarcation

(a) **Permit for Work / Sanction for Work** area shall be identified by:-

- Red cones
- Red & white chain or red & white rigid barrier
- *Danger Notice(s)* attached to adjacent **Live Equipment** as specified by the **Senior Authorised Person**
- *Access Prohibition Notice(s)* attached to structures/**Equipment** where required as specified by the **Senior Authorised Person**
- *Keep Clear Overhead Live Equipment Notice(s)* placed under **Live Equipment** where required

When testing is required the demarcation shall be supplemented by:-

- *Testing Notice* sleeves placed over green cones at the access/egress point.
- *Test Area No Entry Notice(s)* positioned inside the "access / egress" point(s). The "access / egress" point(s) shall be closed



**NSI 6**  
5.3 Cont: to 5.5

(b) **Limited Access Certificate** work area shall be identified where required by:-

- Blue cones
- Blue & white Chain
- *Danger Notice(s)* attached to all adjacent **Live Equipment** outside the demarcated work area where required
- *Access Prohibition Notice(s)* attached to structures where required
- *Keep Clear Overhead Live Equipment Notice(s)* placed under **Live Equipment** where required

5.4 Additional requirements to Section 5.1 and 5.3 where internal access is required for Gas Insulated Switchgear (GIS).

Free standing demarcation shall be supplemented by:

- Self fixing boundary markers around a gas barrier with a red stripe indicating the danger side, a green stripe indicating the safe side, separated by a white stripe.
- *Designated Gas Zone Access Point Notice(s)* attached to all required access points above atmospheric pressure.
- *Vented Gas Zone Access Point Notice(s)* attached to all required access points where the gas zone has been vented.

5.5 **LV and mechanical Equipment**

- (a) When work is to be carried on **LV / mechanical Equipment** which is in proximity to exposed **HV Equipment** the requirements of Section 5.3 or in the case of GIS, 5.4 shall be met.
- (b) When work is carried out on a section of **LV / mechanical panels**, a transparent demarcation curtain shall be attached to the front and rear of the panels, either side of the point of work. The green horizontal arrows shall point inward to the panel where work is being carried out.
- (c) *Danger Notice(s)* shall be fixed to any other adjacent **Equipment** that presents **Danger** or foreseeable risk, in sufficient numbers so as to be visible from the work area at all times.

**Guidance**  
NSI 6  
5.2 to 5.5

## 5 Demarcation in Work Areas

All demarcation shall be carried out in accordance with the standards shown in Appendix B.

5.2 Appendix B “B4 - Where a Natural Fence Already Exists” illustrates the demarcation requirements when a fixed compound with an access gate or an existing fence line forms all or part of the demarcated work area. This situation also includes buildings such as noise enclosures, reactor buildings or a block house etc. within the **HV** compound.

5.3 *Danger Notice(s)* shall be attached to **Equipment** and structures adjacent to the demarcated work area, in sufficient numbers to be clearly visible from all sides. Refer to Appendix B. The **Senior Authorised Person** has the option to utilise free standing **Danger** signs as an alternative.

5.3(a) Where reasonably practicable boundary marking shall be arranged so that all structures supporting any **Live Equipment** are excluded from the demarcated work area.

Where this is not reasonably practicable precautions against unsafe access shall be taken. Unsafe access shall be clearly identified by attaching sufficient *Access Prohibition Notice(s)* visible from all directions of approach to the **Equipment** and structures at a level beyond which it is unsafe to pass to warn people of **Danger**. Refer to Appendix B.

*Testing Notice Sleeves* etc. are required when Testing is carried out under Management Procedure NSI 9 – “Testing HV Equipment” or under an **Approved** restoration of motive power procedure (ROMP).

5.5 Proximity to exposed **HV Equipment** includes block houses, reactor houses etc. within the **HV** compound. This does not include relay / LVAC / telecomm rooms within the main control building.

Where **Danger** may arise from **Live LV** terminals, screening shall be applied in accordance with Management Procedure NSI 12 “Low Voltage Equipment”.

**NSI 6**  
6.1 to 6.3

**6 Demarcation of Risk Management Areas and General Hazard Zones**

6.1 Risk Management Areas subject to a risk management procedure shall be designated by:

- Yellow cones
- Yellow and black plastic chain or barriers
- *Risk Management Zone Hazard Notice(s)* attached to the chain

6.2 Information on the risk management area shall be recorded at the **Location**.

6.3 General hazard zone(s) shall be designated by:

- Yellow cones
- Yellow and black plastic chain or rigid barrier e.g. Heras fence / crowd barriers

**Guidance**  
NSI 6  
6.1 to 6.2

**6 Demarcation of Risk Management Areas and General Hazard Zones**

6.1 All demarcation shall be carried out in accordance with the standards shown in Appendix C.

6.2 Details to be recorded on the Substation Status Board.

**NSI 6**  
7.1 to 7.5

## **7 Roles & Responsibilities – Demarcated Work Areas**

7.1 The **Senior Authorised Person** shall decide whether demarcation is required for work carried out under a **Limited Access Certificate**.

7.2 Where a work area is to be demarcated:-

- (a) The **Senior Authorised Person** shall instruct a **Competent Person** authorised to full NSI 6 and 8 on the positioning of the demarcation equipment. Demarcation equipment shall then be erected by the **Competent Person** or by a **Person** under the **Personal Supervision** of the **Competent Person**

Demarcation shall be:-

- Erected after safety precautions have been established but before any **Safety Document(s)** is issued
  - Removed after clearance of the **Safety Document(s)** but before cancellation
- (b) The **Senior Authorised Person** issuing the **Safety Document** shall ensure that the designated work area has been demarcated correctly by the **Competent Person** before issuing the **Safety Document**
- (c) Entry to a demarcated area is only permitted by a member of the **Working Party** under the terms of the **Safety Document**.

7.3 Before work commences on any day the **Safety Document** recipient shall undertake an inspection of the demarcation equipment to confirm its continuing suitability. The **Safety Document** recipient shall then enter their name and the valid date on the *Access Point Notice*.

It is permissible for the **Safety Document** recipient to stand up a cone or reaffix a chain that has accidentally fallen to ground. If there has been significant disruption to the demarcation equipment then a **Senior Authorised Person** shall be contacted prior to its re-instatement.

7.4 No personnel shall enter or exit a demarcated work area by crossing over or under any chain or barrier. A designated access point shall be used.

7.5 The **Safety Document** recipient identified on the *Access Point Notice* is permitted to dismantle chains, cones or barriers at the designated vehicle access point(s) to allow access / egress of plant and vehicles.

The chains, cones or barriers at the designated vehicle access point(s) shall be restored immediately once the plant / vehicles have entered or left the work area.

**NSI 6**  
7.6 to 7.7

- 7.6 If there is more than one **Safety Document** in force for one specific demarcated work area, it will only be necessary for one of the **Safety Document** recipients to complete the requirements of 7.3. There shall be mutual agreement between the **Safety Document** recipients.
- 7.7 When testing is to be carried out, the **Safety Document** recipient shall ensure that all *Testing Notice* sleeves, *Testing Area No Entry Notice(s)* are correctly displayed and “access / egress” point(s) closed before the testing commences. These shall be removed upon completion of the test.

**Guidance**  
NSI 6  
7.1 to 7.6

**7 Roles & Responsibilities – Demarcated Work Areas**

- 7.1 Where reasonably practicable a **Limited Access Certificate** work area shall be demarcated, especially inside an **HV** compound.

An example of when it may not be reasonably practicable to erect demarcation is where the work takes place across the whole **HV** compound such as when spreading weed killer or when doing non-intrusive ground surveys for buried services.

- 7.3 An example of significant disruption is where there have been strong winds overnight and the boundary of the demarcated work area has been substantially blown over to the extent that it is not clear where the cones / chain should be re-erected etc.

- 7.5 If the **Senior Authorised Person** does not want to allow the **Safety Document** recipient to interfere with the access point(s) then this shall be stated on the **Safety Document** under the “Further Precautions” section.

If the **Senior Authorised Person** decides to utilise a designated vehicle access point, this shall be clearly identified to the **Competent Person** on a sketch and incorporated in the RAMS.

- 7.6 When there is more than one **Working Party** working in a single demarcated work area, the first **Safety Document** recipient to start work in the demarcated work area each day shall complete the requirements of 7.3.

When more than one **Working Party** is set to work, the **Senior Authorised Person** shall ensure co-ordination between each **Working Party** is established, ensuring all activities that could affect another **Working Party** are considered. Where appropriate this shall be recorded on all toolbox talk forms. During the work it is each **Competent Person's** responsibility to ensure adequate co-ordination is maintained.

**NSI 6**  
8.1 to 8.2

**8 Roles & Responsibilities - Risk Management Areas and General Hazard Zones**

- 8.1 A **Competent Person** authorised to full NSI 6 and 8 working to instructions of a **Senior Authorised Person** can erect / remove demarcation of *Risk Management Hazard Zone(s)*.

- 8.2 A **Competent Person** authorised to full NSI 6 & 8 can erect / remove demarcation of general hazard zone(s).

**NSI 6**  
9.1 to 9.2

**9 Safety Rule Demarcation in a CDM Demarcated Area**

- 9.1 Safety Rule demarcation and Construction Design and Management Regulations (CDM) demarcation shall be clearly identified.
- 9.2 Where it is identified that the CDM area will be the same physical size as the Safety Rule demarcation work area. The **Senior Authorised Person** can use either:-
- (a) CDM demarcation as part of the Safety Rule demarcation  
or
  - (b) Safety Rule demarcation as part of the CDM demarcation

**Guidance**  
NSI 6  
9.1 to 9.2

**9 Safety Rule Demarcation in a CDM Demarcated Area**

- 9.1 The method and standards of demarcation for construction sites subject to the Construction (Design and Management) Regulations (CDM) is the responsibility of the Principal Contractor and shall be appropriate to the levels of risk associated with the construction work.
- Where the CDM demarcated zone is larger than any one Safety Rule demarcated work area, Safety Rule demarcation shall be in accordance with Section 5 of this NSI. Refer to Appendix D.
- Where Safety Rule demarcation is in force all demarcation within the boundaries of the demarcated work area shall be to Management Procedure NSI 6 "Demarcation in Substations".
- 9.2 Where it is identified that the CDM area will be the same physical size as the Safety Rule demarcation work area it is not appropriate to double delineate.
- CDM demarcation may be used to define the limits of work area under a **Limited Access Certificate** but only when the limits of work can be clearly specified on the **Limited Access Certificate** as a means of achieving **Safety from the System**.
- 9.2(a) It can be agreed with the Principle Contractor that the CDM demarcation can be used as part of the Safety Rule demarcated work area.
- In this instance the CDM demarcation shall be used as a natural boundary fences. Green cones shall be placed at the entrance point and 5.1(e) shall be met Refer to Appendix D.
- 9.2(b) It can be agreed with the Principle Contractor that the Safety Rule demarcation can be used as part of the CDM demarcation.
- In this instance additional access point stands shall be used with a CDM area notice attached. Refer to Appendix D.

### Appendix A – Examples of NSI 6 Demarcation Drawing

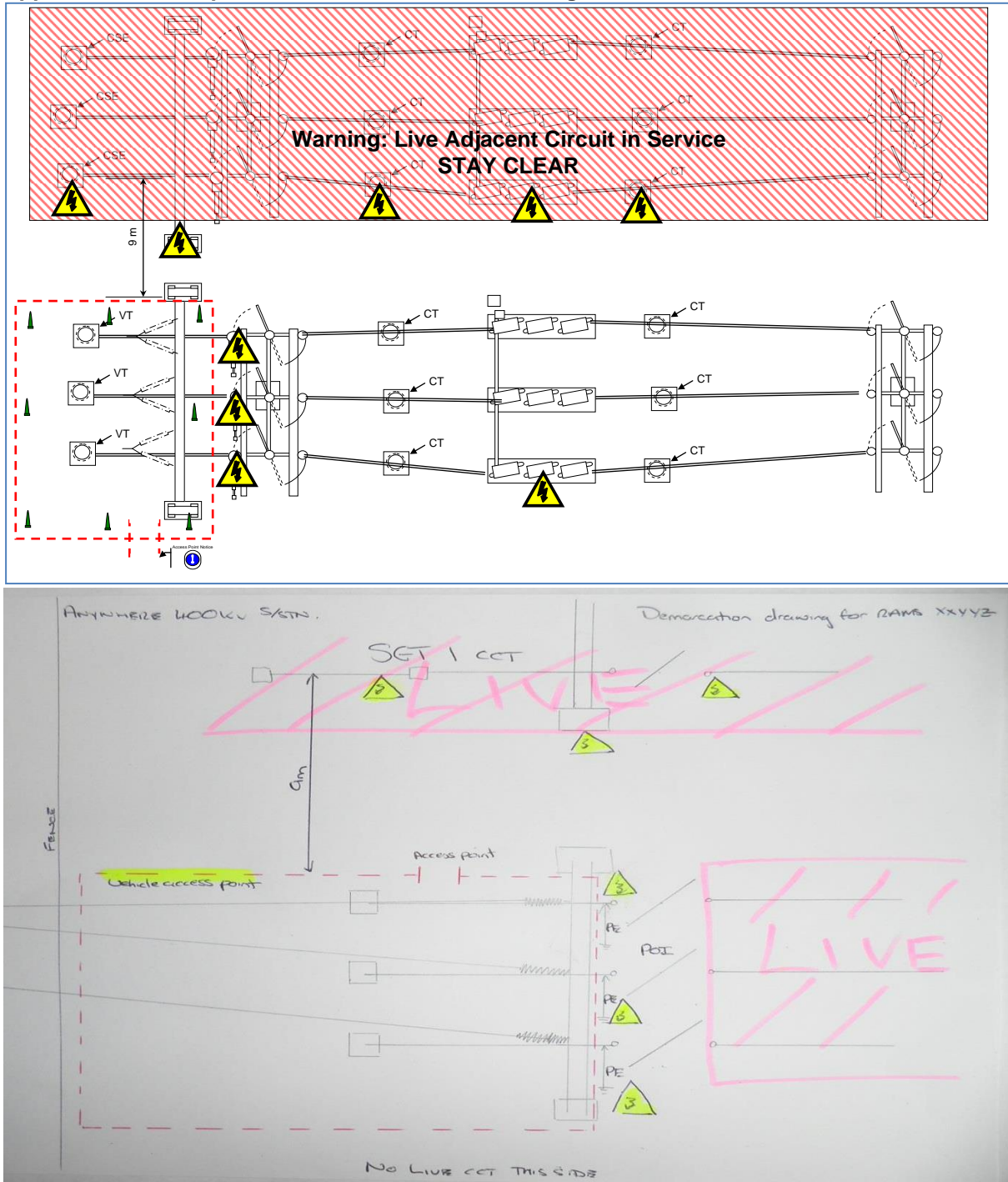

#### Notes:

1. Drawing can be in any format e.g. marked-up photocopy of layout drawing, hand drawn etc. but must clearly show the position of demarcation equipment and the location of the work area relevant to nearby live equipment.
2. Positions of demarcation equipment must be clearly shown on the drawing e.g. use of dimensions or shown positioned against clear fixed objects e.g. trenches, fences, equipment structures etc.
3. Plan and Elevation drawings may be required e.g. for GIS work areas or where overhead live equipment needs to be identified/demarcated.

## Appendix B – Examples of Demarcation for Work Areas B1 – Permit for Work

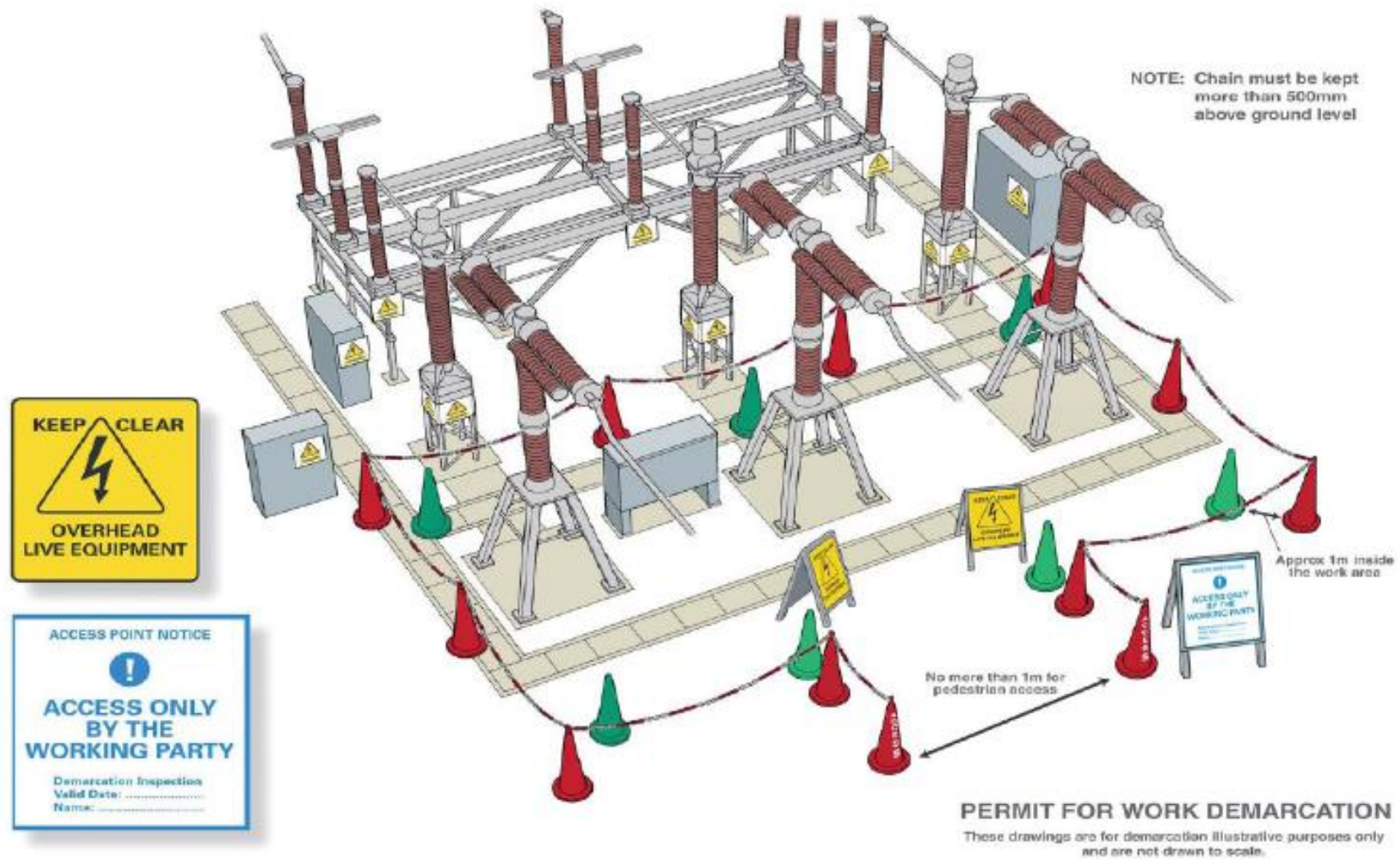



**B1 – Permit for Work –**

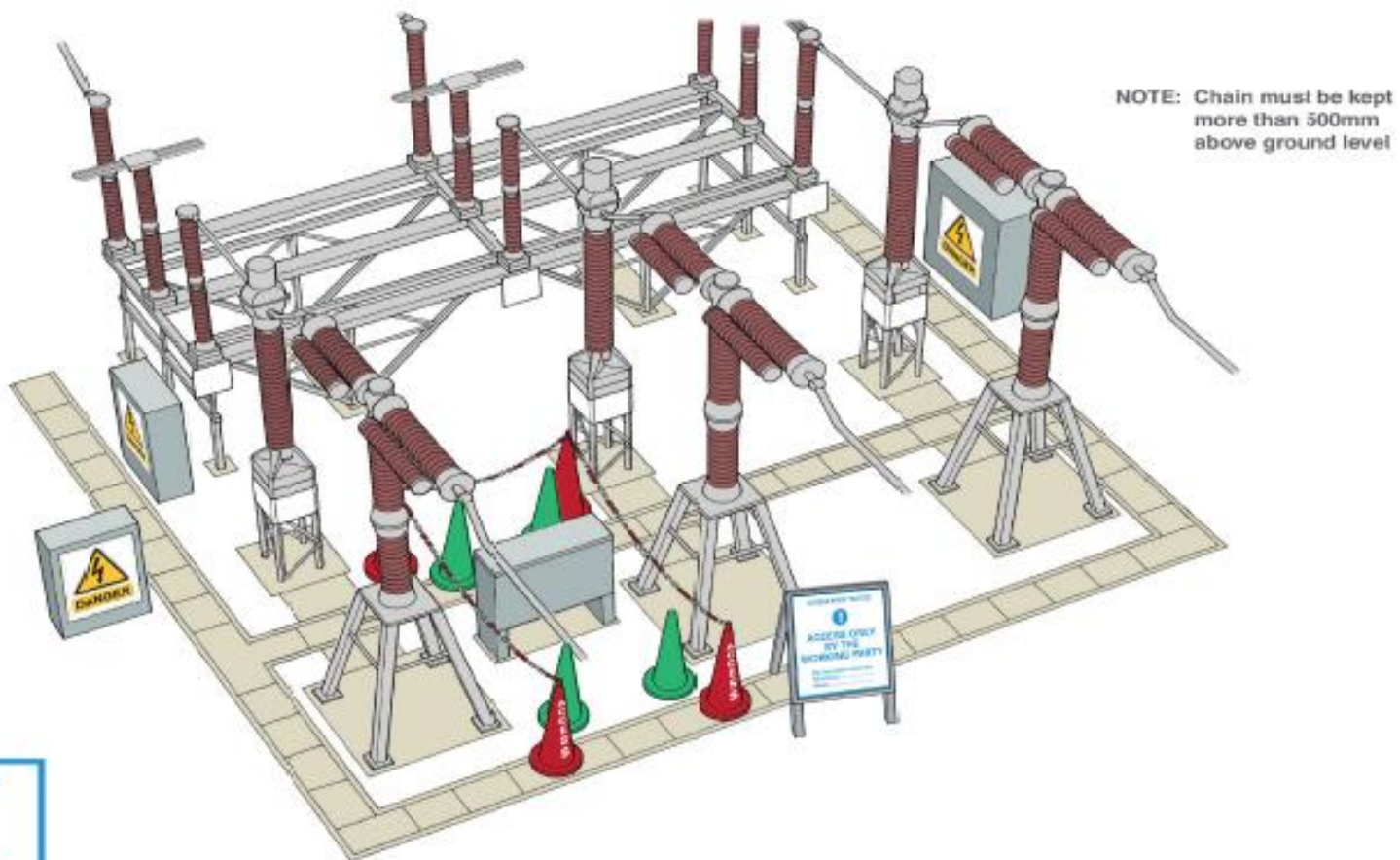

**PERMIT FOR WORK DEMARCATION**

These drawings are for demarcation illustrative purposes only and are not drawn to scale.

**B2 – Testing**

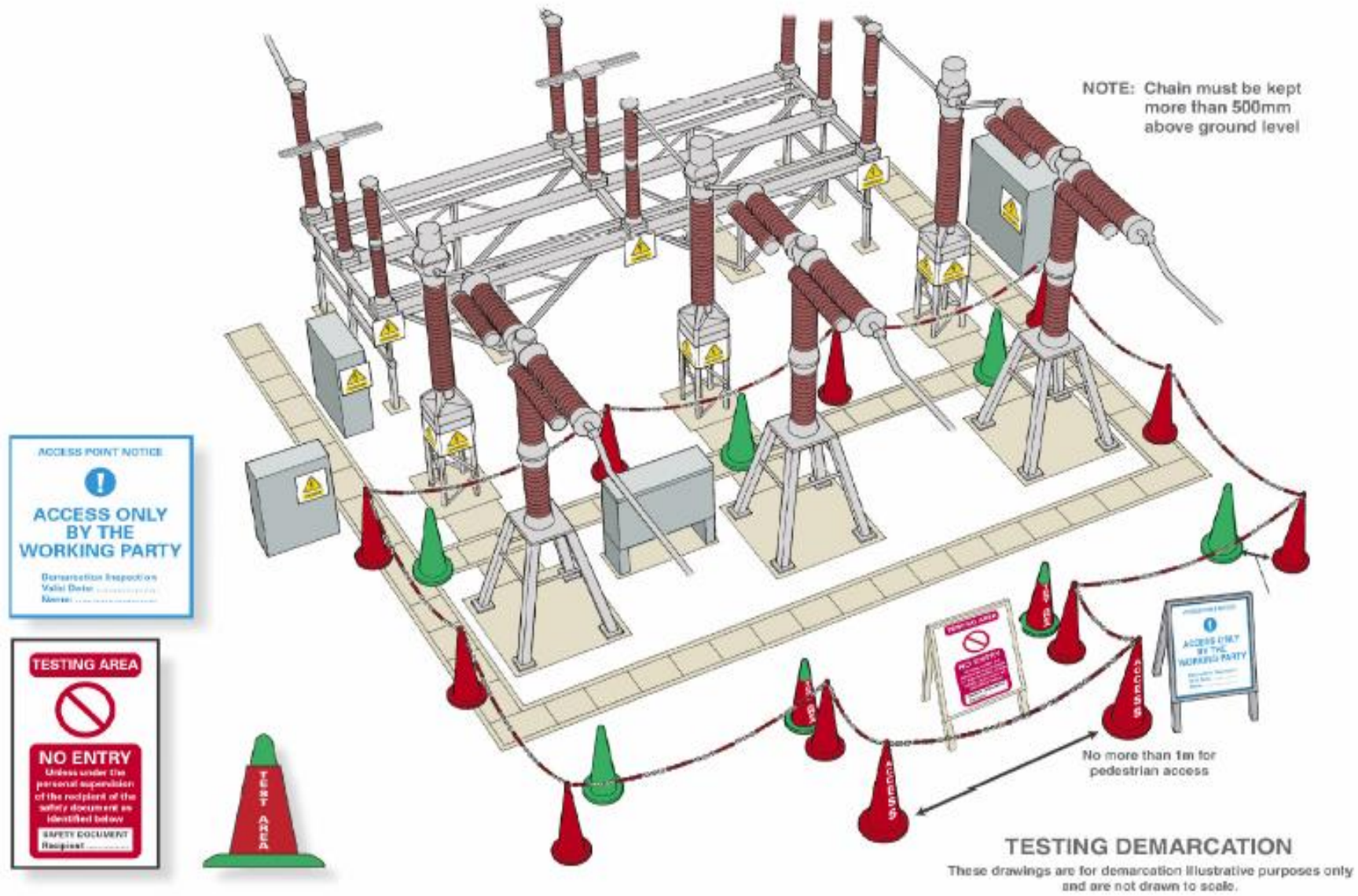

### B3 – Limited Access Certificate

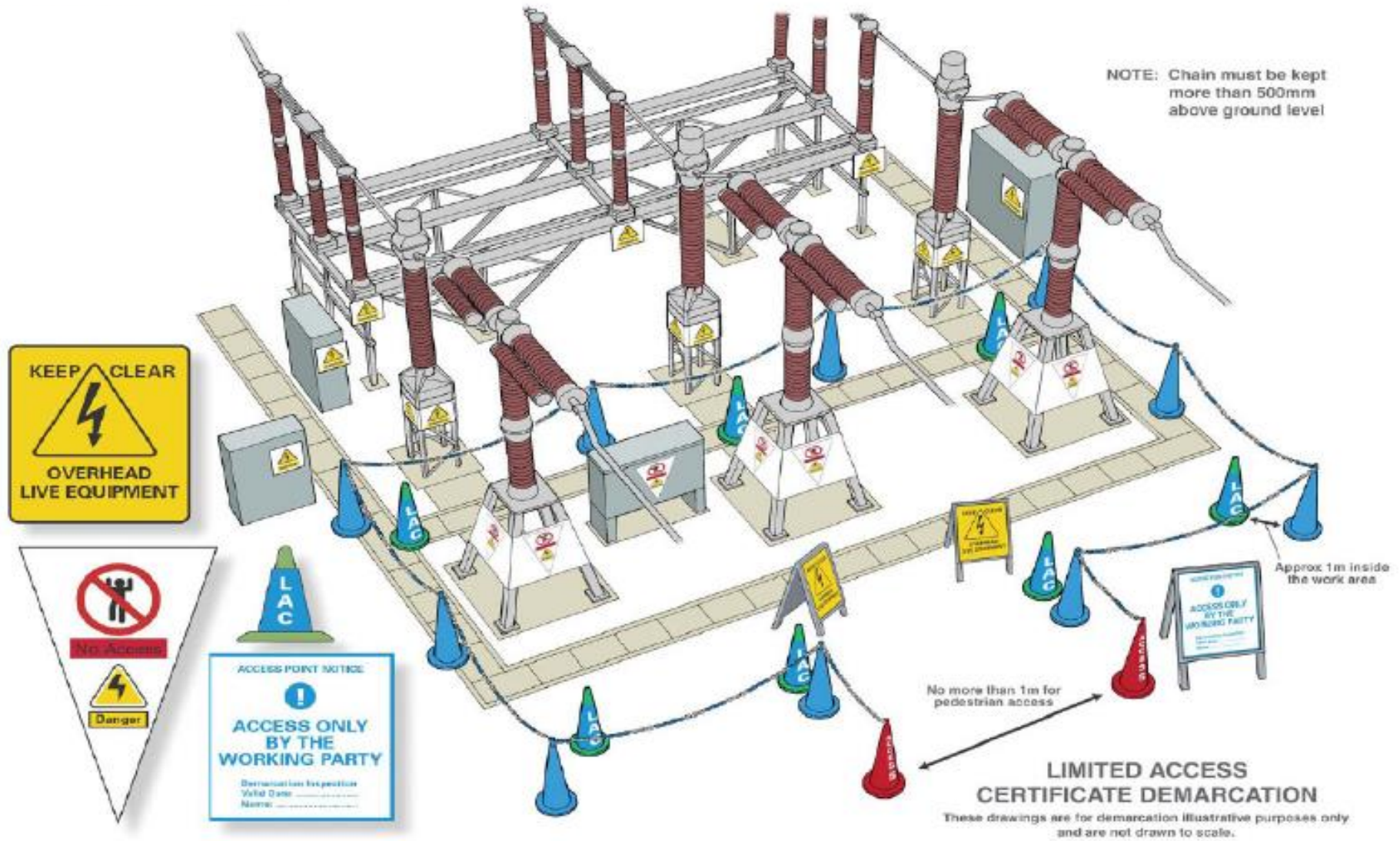

## B4 – Where a Natural Fence Already Exists

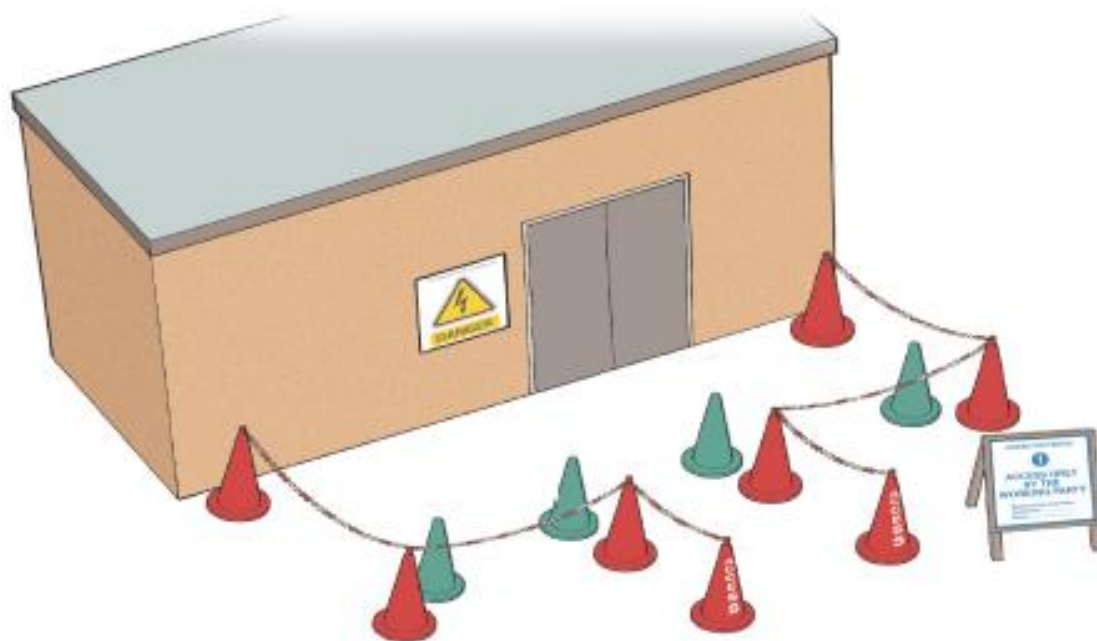

**NOTE:** If similar components are immediately adjacent to the one being worked on, 'Danger' notices would be affixed to the outside of the gates of the other compounds.



## WHERE A FIXED FENCE ALREADY EXISTS

These drawings are for demarcation illustrative purposes only  
and are not drawn to scale.

## B4 – Where a Natural Fence Already Exists

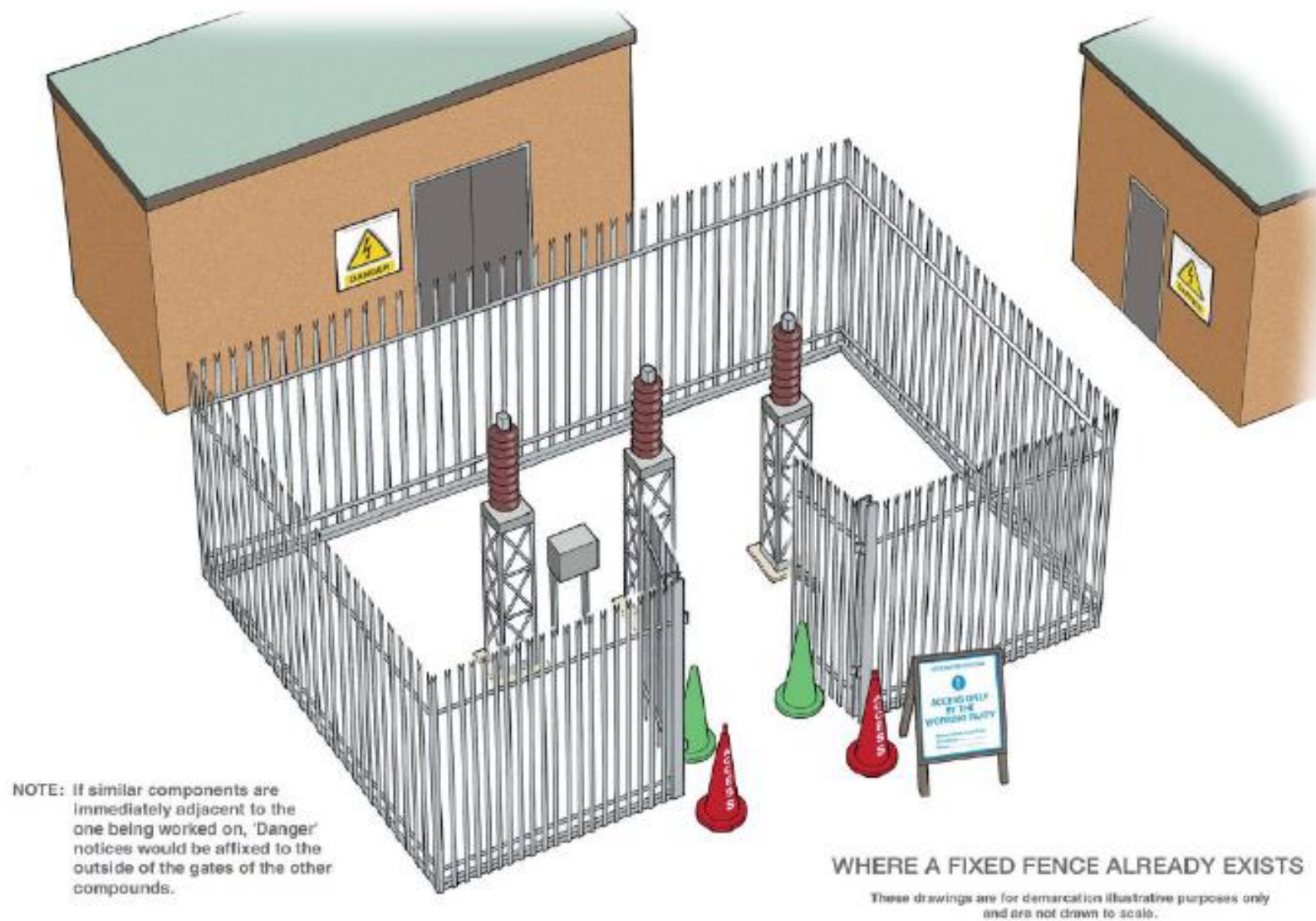

## B4 – Where a Natural Fence Already Exists



NOTE: If similar components are immediately adjacent to the one being worked on, 'Danger' notices would be affixed to the outside of the gates of the other compounds.

### WHERE A FIXED FENCE ALREADY EXISTS

These drawings are for demarcation illustrative purposes only and are not drawn to scale.

## B5 – SF<sub>6</sub> Gas Insulated Switchgear

**NOTE:** Gas zone access point notice displaying a mandatory symbol allowing access after depressurisation and purging of compartment.

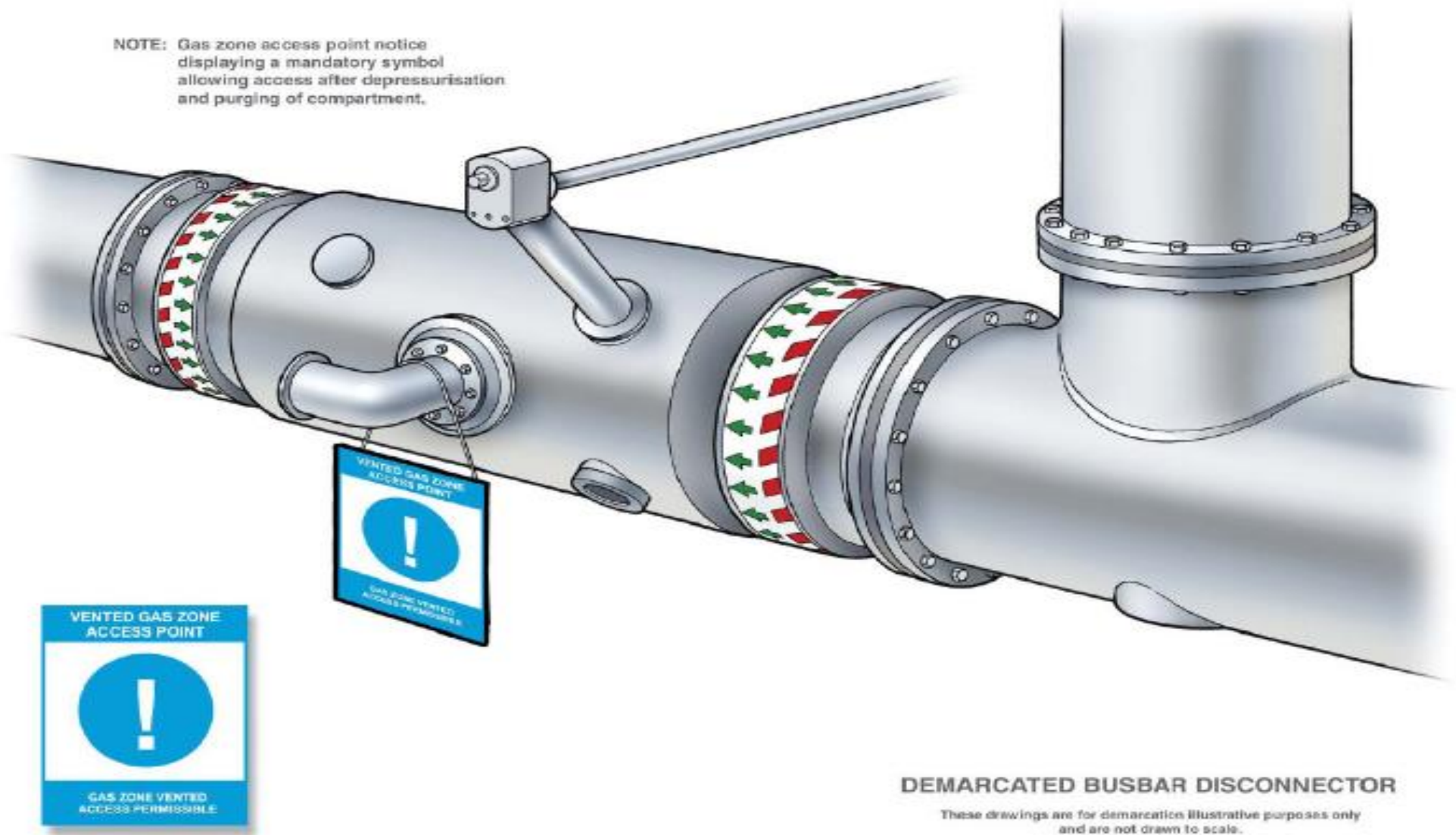

## B5 – SF<sub>6</sub> Gas Insulated Switchgear

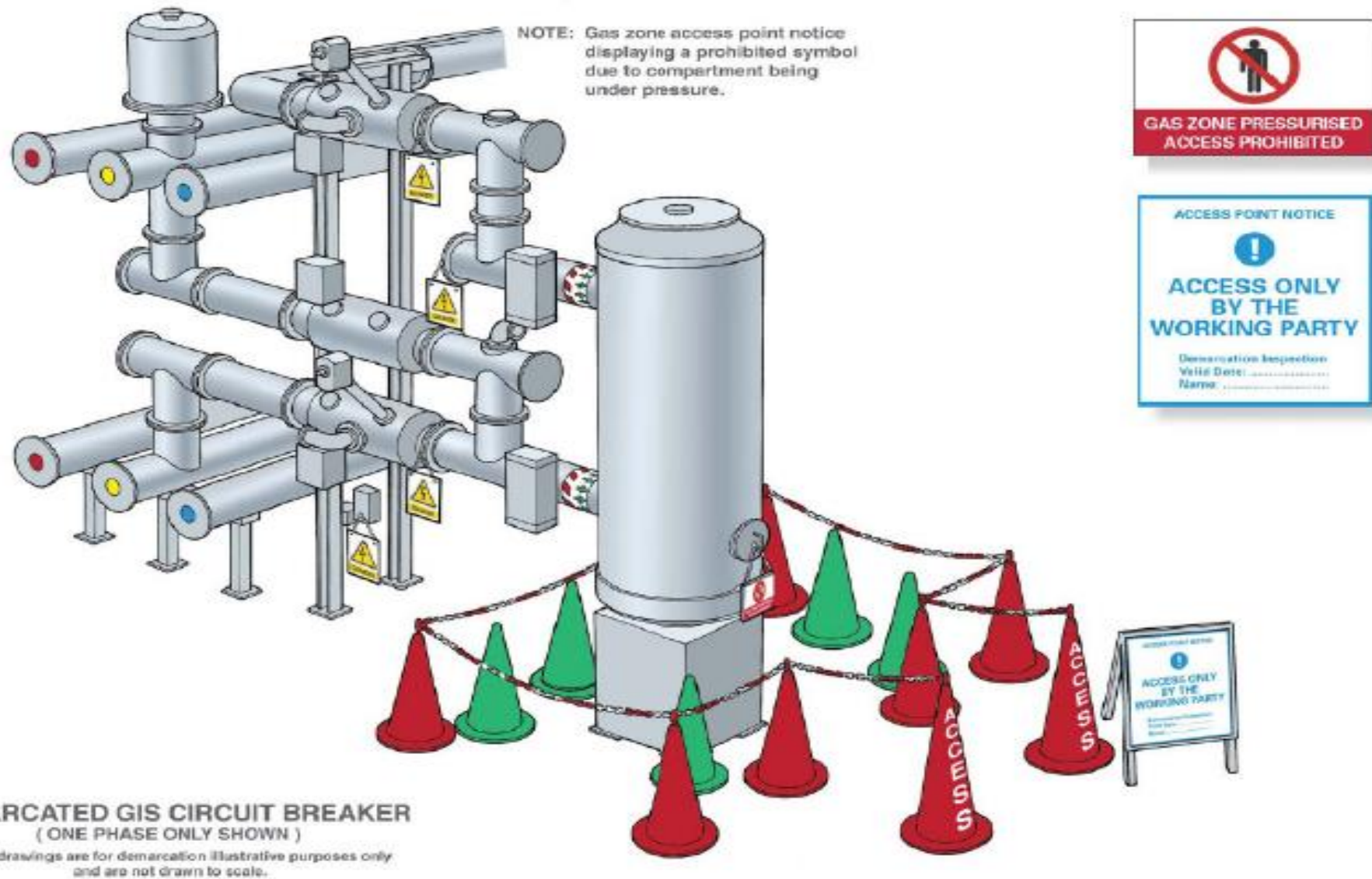



## B6 – Low Voltage Equipment –

NOTE: Similar demarcation at rear of panel

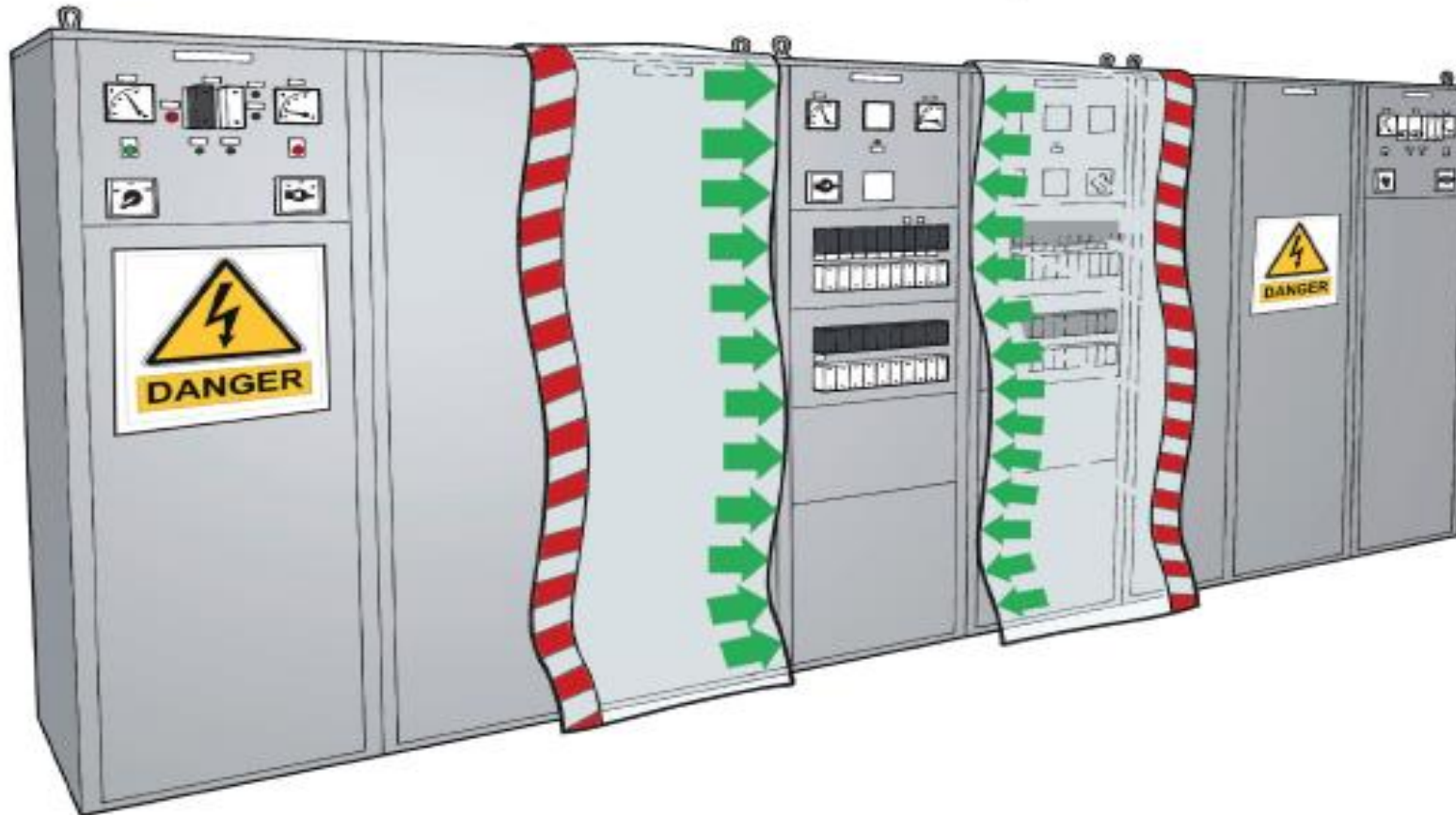

### 50 VOLT DISTRIBUTION BOARD

These drawings are for demarcation illustrative purposes only  
and are not drawn to scale.

## B6 – Low Voltage Equipment

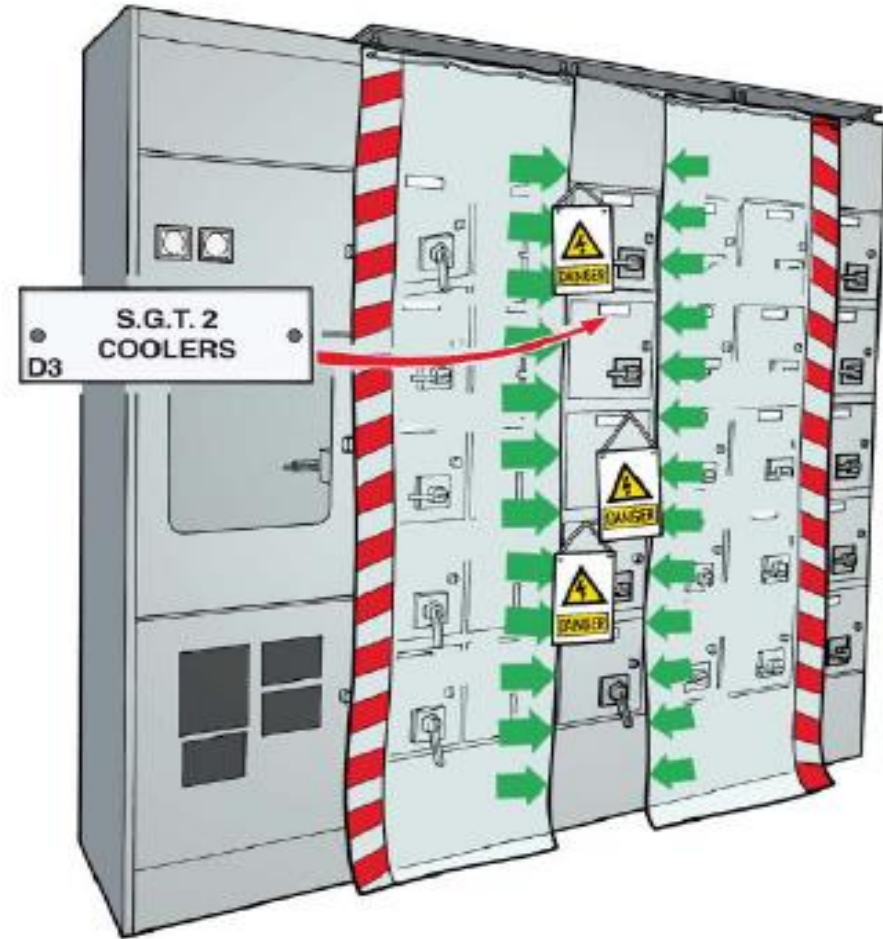
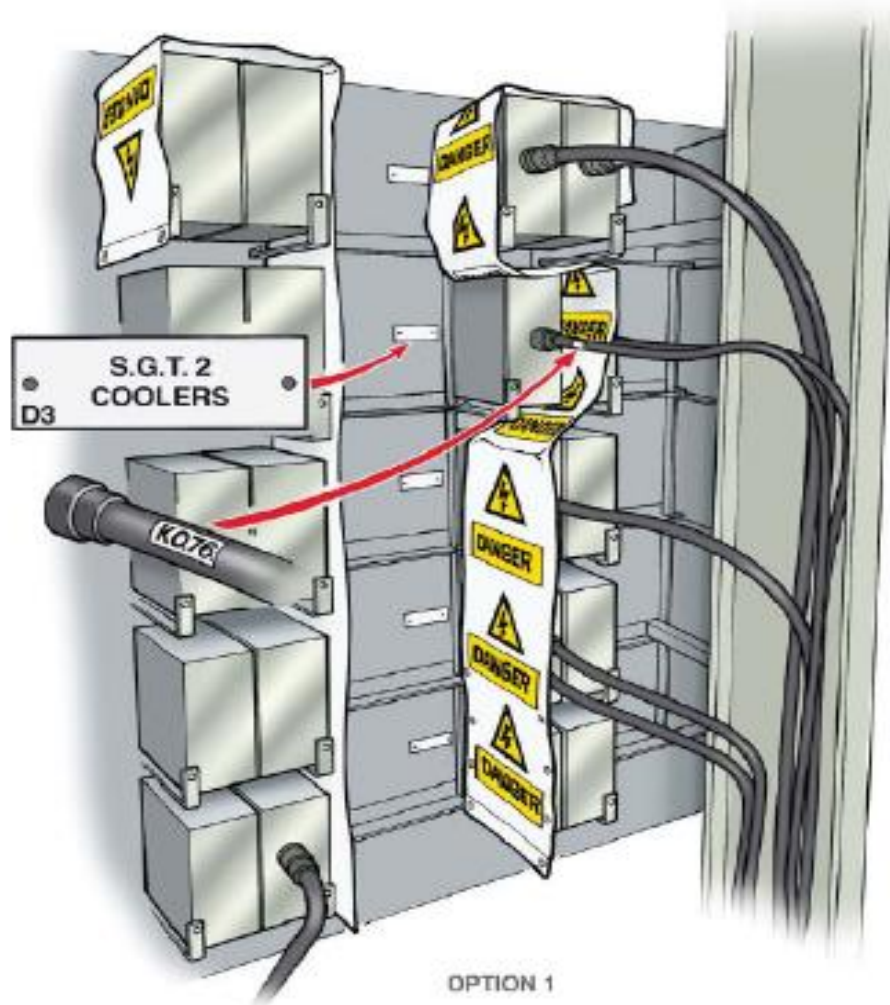

### INSTALLATION OF S.G.T. 2 COOLER SUPPLY

These drawings are for demarcation illustrative purposes only  
and are not drawn to scale.

## B6 – Low Voltage Equipment

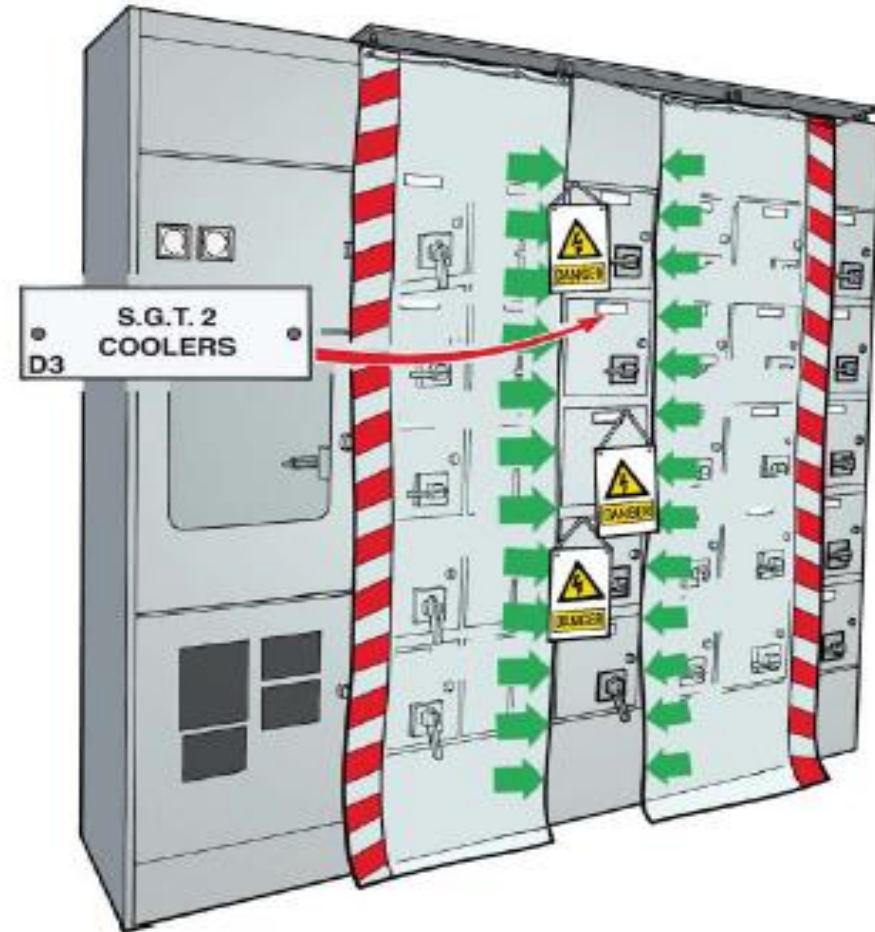
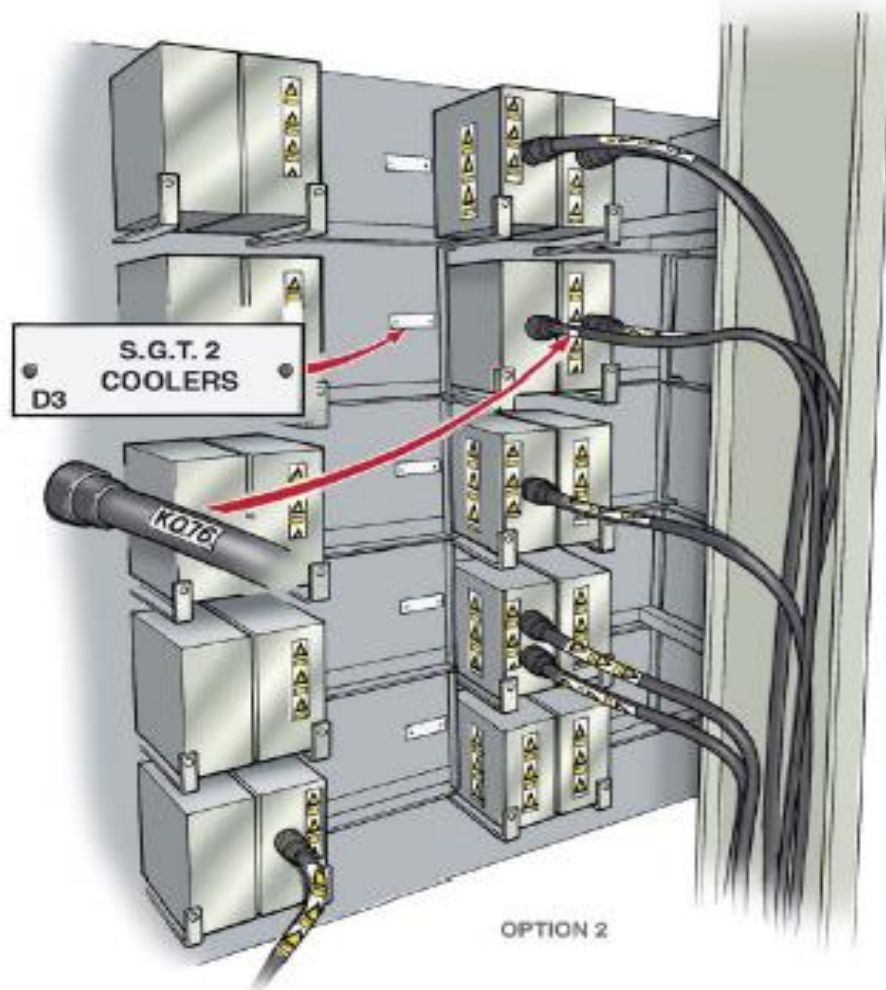

### INSTALLATION OF S.G.T. 2 COOLER SUPPLY

These drawings are for demarcation illustrative purposes only  
and are not drawn to scale.

## B6 – Low Voltage Equipment

NOTE: An example of danger tape preventing accidental removal of wrong terminal connections

Danger tape or danger signs may be used in this situation

Where danger may arise from these terminals, screening material must be used

Rack being worked on

### INSTALLATION OF A NEW TERMINAL RACK

These drawings are for demarcation illustrative purposes only and are not drawn to scale.

## B6 – Low Voltage Equipment

NOTE: Screening material must not allow the build-up of hydrogen gas under the screening.

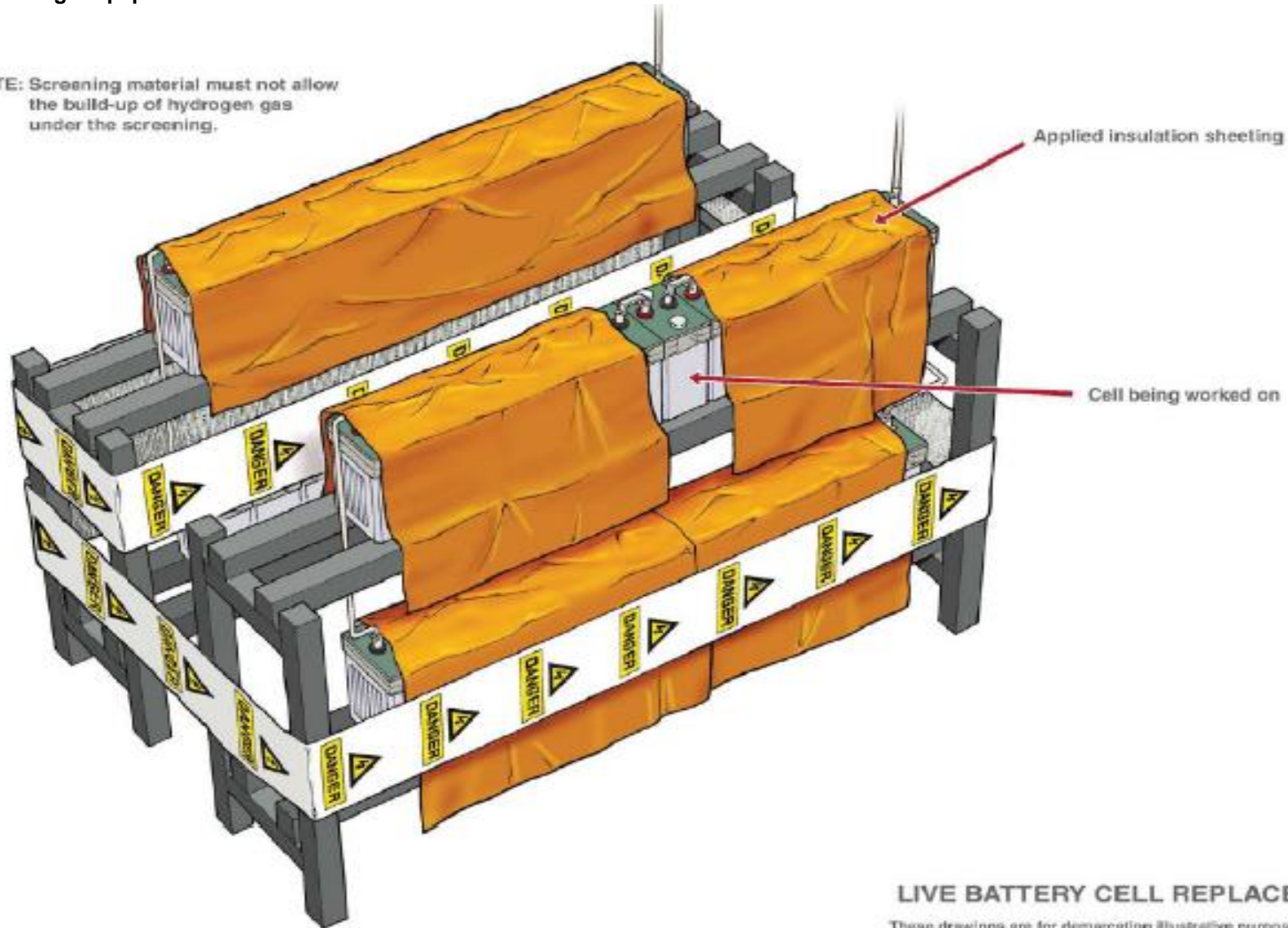

### LIVE BATTERY CELL REPLACEMENT

These drawings are for demarcation illustrative purposes only and are not drawn to scale.

**B7 – Mechanical Equipment**

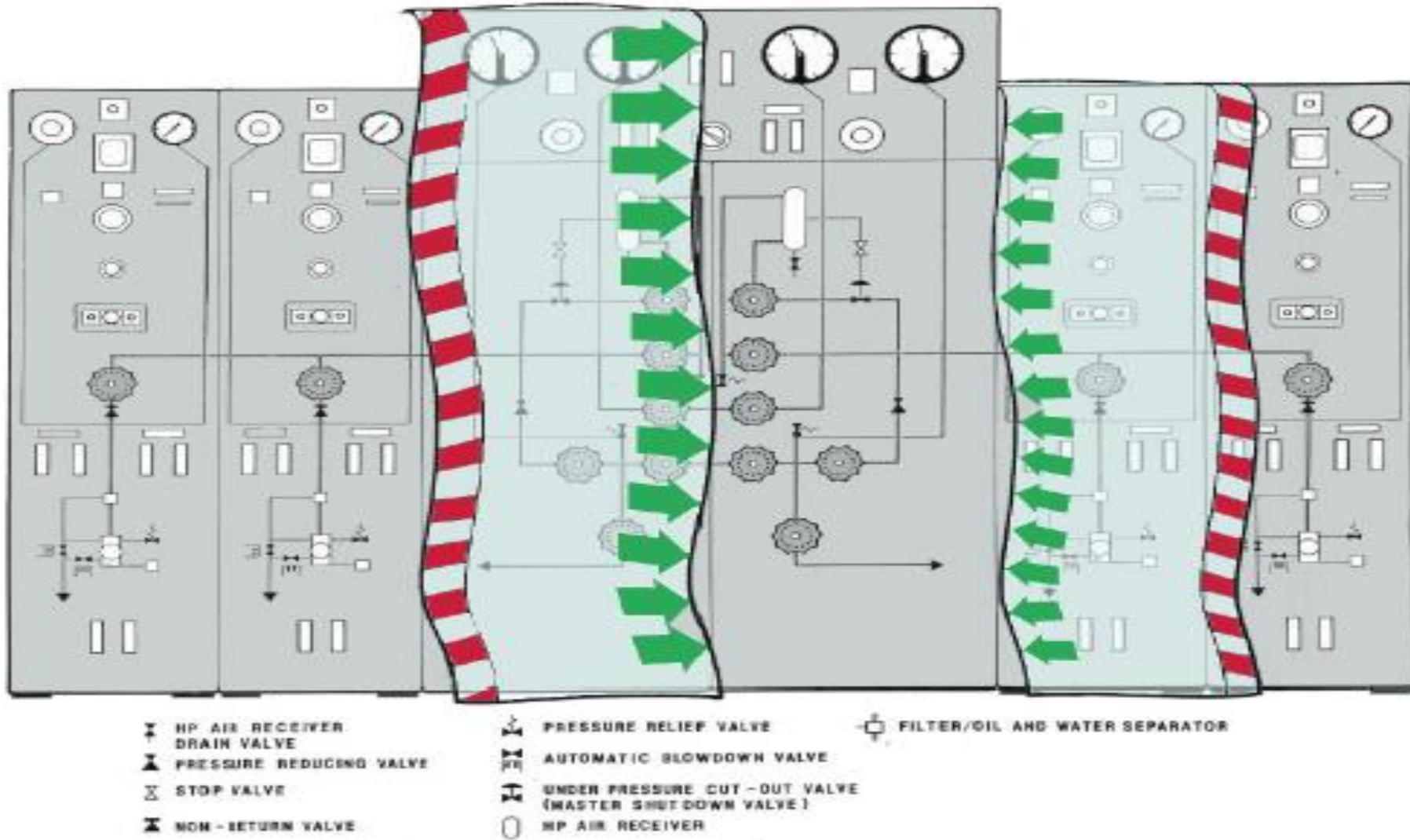

**B7 – Mechanical Equipment Rear view of panel**

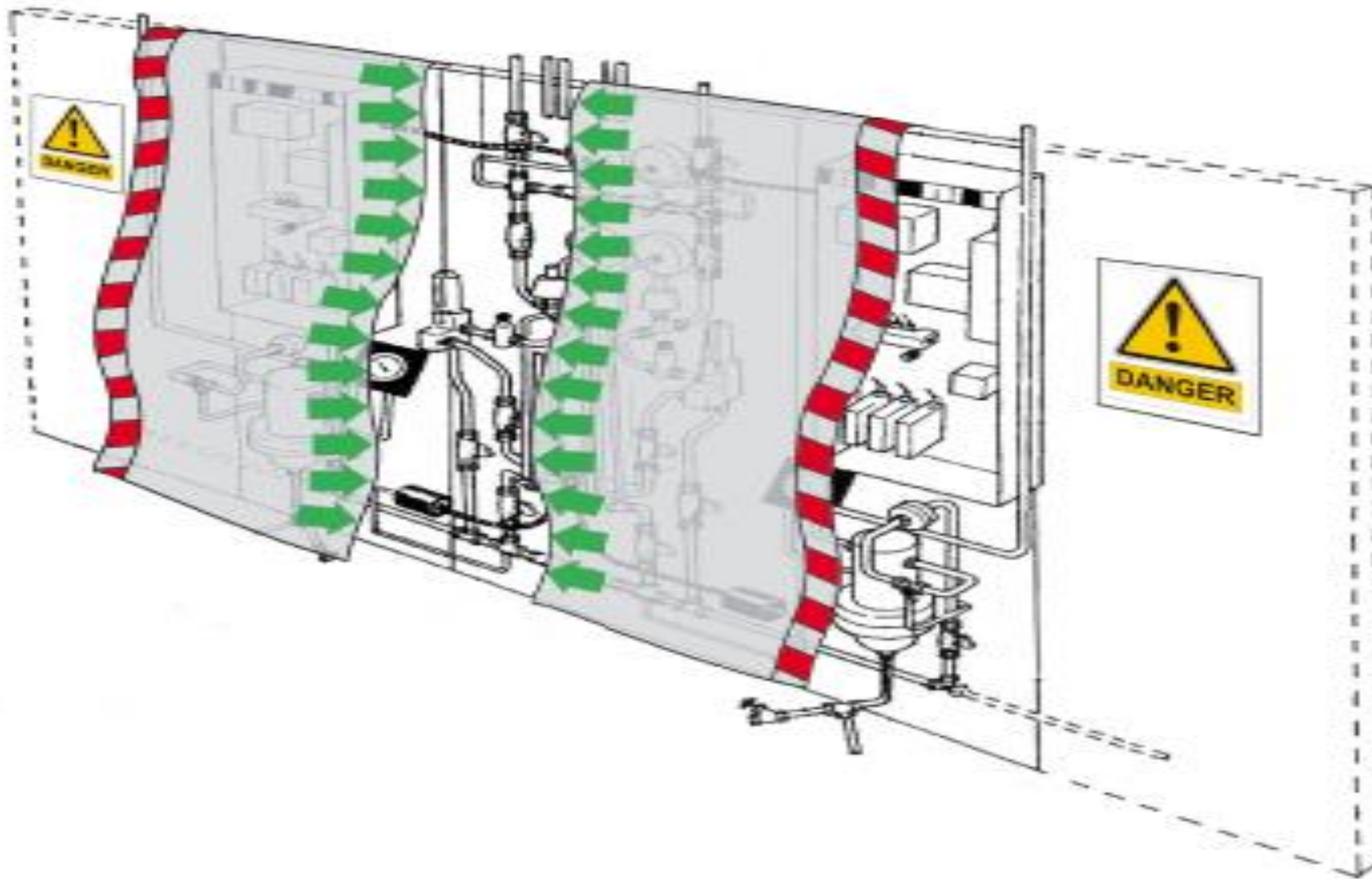

## Appendix C – Examples of Demarcation for Risk Management and Hazard Zones

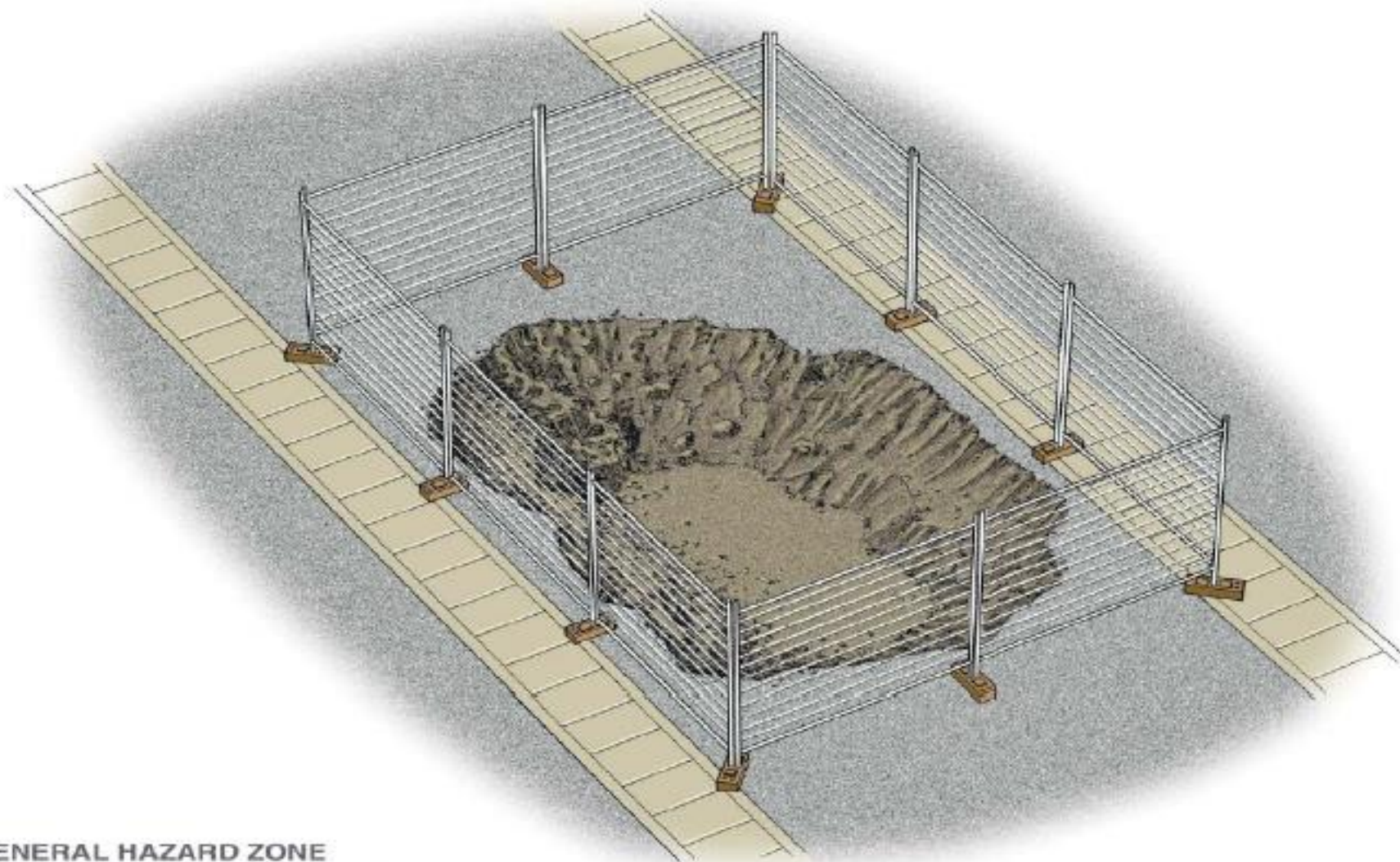

### GENERAL HAZARD ZONE

These drawings are for demarcation illustrative purposes only  
and are not drawn to scale.



## Appendix C – Examples of Demarcation for Risk Management and Hazard Zones

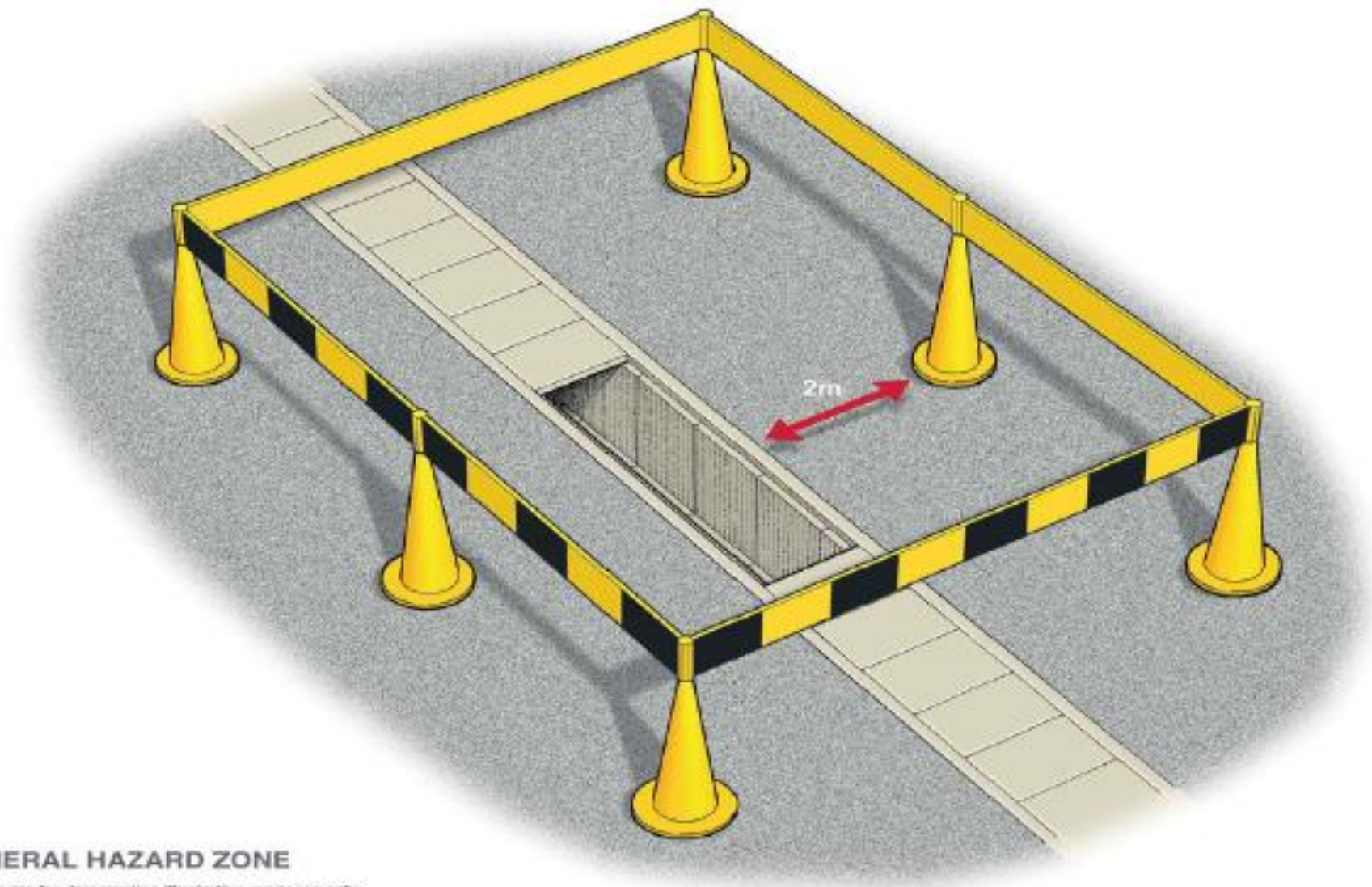

### GENERAL HAZARD ZONE

These drawings are for demarcation illustrative purposes only  
and are not drawn to scale.

### Appendix C – Examples of Demarcation for Risk Management and Hazard Zones

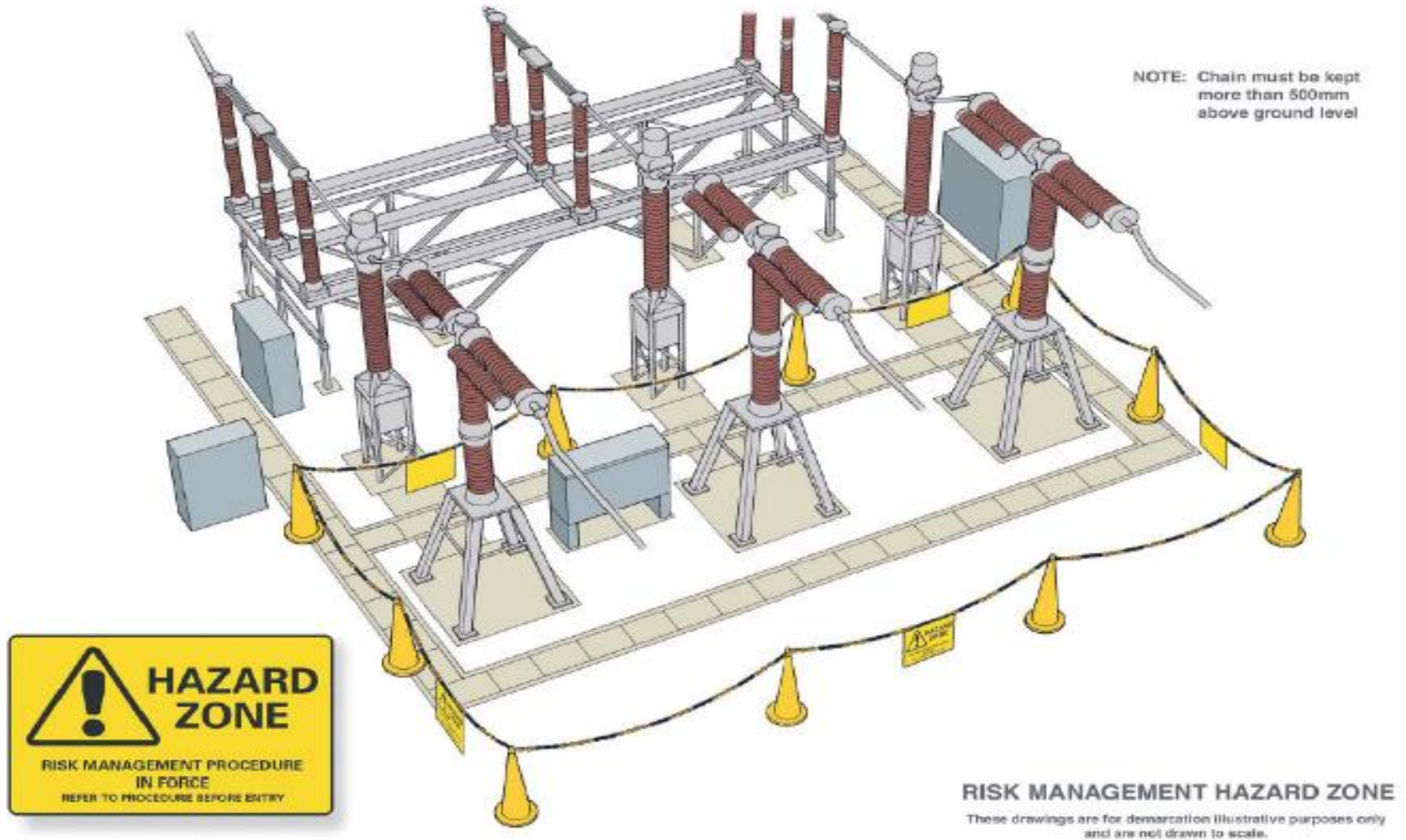

**Appendix D – Examples of Safety Rule Demarcation in a CDM Area**  
**D1 – Large CDM Area**



## D2 – CDM Demarcation as Part of the Safety Rule Demarcation



### D3 – Safety Rule Demarcation as Part of the CDM Demarcation

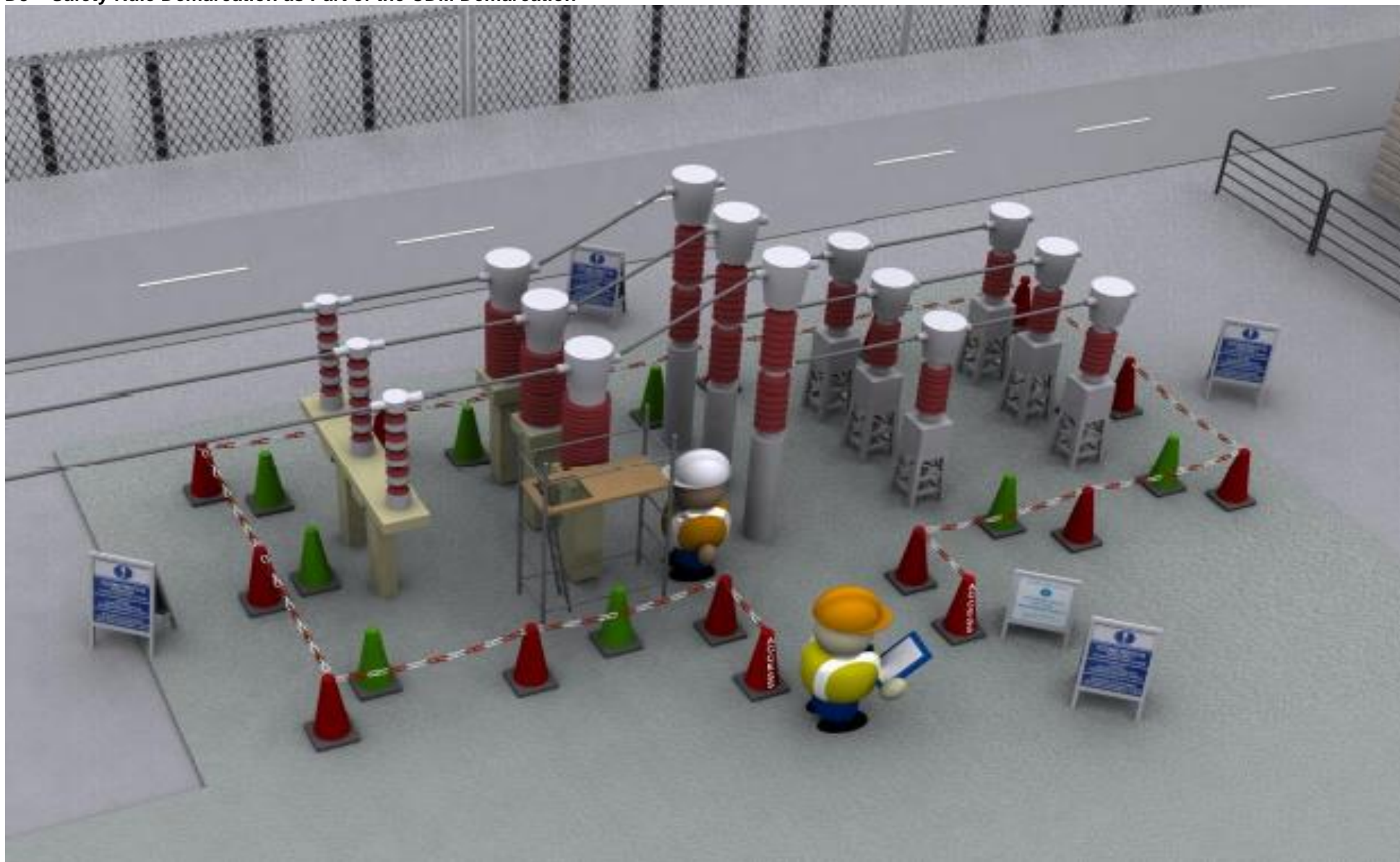

**Appendix E – Safety Notices**

**SAFETY NOTICES**



**ACCESS PROHIBITION NOTICE  
WRAP ROUND  
OR NOTICE**



**ELECTRICAL  
DANGER NOTICE  
WRAP ROUND  
OR NOTICE**



**MECHANICAL  
DANGER NOTICE  
WRAP ROUND  
OR NOTICE**



**DESIGNATED  
GAS ZONE ACCESS POINT NOTICE  
(DISPLAYING GAS ZONE  
PRESSURISED  
ACCESS PROHIBITED)**



**VENTED GAS ZONE  
ACCESS POINT NOTICE  
(DISPLAYING GAS ZONE VENTED  
ACCESS PERMISSIBLE)**



**TESTING AREA  
NO ENTRY**



**RISK MANAGEMENT HAZARD ZONE  
NOTICE**



**KEEP CLEAR OVERHEAD  
LIVE EQUIPMENT NOTICE**



**ACCESS POINT NOTICE**

---

## Appendix F - Authorisation Matrix for Contractors Personnel

Contractors appointment under this NSI shall be limited to the following sections.

<b>Contractor Personnel</b>	<b>Person</b>	<b>Competent Person</b>	<b>Authorised Person</b>	<b>Senior Authorised Person</b>
Sections		All Sections		