

National Grid UK Electricity Transmission plc

Uncontrolled when printed

NATIONAL SAFETY INSTRUCTION and Guidance

NSI 3 HIGH VOLTAGE METAL CLAD SWITCHGEAR WITH SPOUTS

Copyright National Grid plc 2014 ©, all rights reserved. No part of this publication may be reproduced, stored in a retrieval system, or transmitted in any form or by any means electronic, mechanical, photocopying, recording or otherwise, without the written permission of National Grid obtained from the issuing location.

The contents of National Grid documents are based on the needs of National Grid and the conditions under which it operates. It shall not therefore be assumed that the contents stated therein necessarily meet the particular circumstances and requirements of other organisations. The principles set out in this document are for information only and therefore National Grid is not liable to any third party for any loss or damage resulting from reliance on the contents. It is the responsibility of such external organisations to check that the document is the latest version and is appropriate for their purposes.

DOCUMENT HISTORY

Issue	Date	Summary of Changes / Reason	Author(s)	Approved By (Title)
1	February 2011	Reformatted and re-drafted to follow 3 rd edition Electricity Safety Rules layout.	NSI Working Group	MDE Manager Les Adams 
2	April 2014	Renamed as "National Safety Instruction and Guidance" which now incorporates and replaces NSI 3 Issue 3 and NSI 3 Guidance Issue 1.	NSI Review Group	ETAM Operations North Manager Mike Dean

KEY CHANGES

Section	Amendments
All	Minor grammar and format changes – aligned to new NSI format.

HIGH VOLTAGE METALCLAD SWITCHGEAR WITH SPOUTS

CONTENTS

	Page
1 Scope	1
2 Definitions	1
3 Dangers	1
4 Control of Access to Spouts	2
5 Work on the Busbar Spouts, Busbars and Busbar Connections of a Multi-Panel Switchboard	3
6 Work on Feeder Spouts, Voltage Transformer Spouts and Single Panel Busbar Spouts and associated Connections	7
7 Work on a Circuit Breaker or Voltage Transformer	10
Appendix A – Authorisation Matrix for Contractors Personnel	14

1 SCOPE

To apply the principles established by the Safety Rules and provide guidance on National Safety Instruction 3, when applying the principles established by the Safety Rules to achieve **Safety from the System** for personnel working on the busbar, voltage transformer, feeder spouts and associated connections of **High Voltage** metalclad switchgear. It also covers working on a circuit breaker or voltage transformer when removed from its service position.

The layout of this guidance note reflects that of legislative codes of practice, where the rule (or mandatory obligation) is identified by a green panel on the left-hand side. The guidance follows after the rule and is identified by a blue panel.

Within National Grid, guidance notes hold equivalent status of an Approved Code of Practice (ACOP) in law. If not followed, you will be required to demonstrate that your safe system of work is of an equal or higher standard.

2 DEFINITIONS

Terms printed in bold type are as defined in the Safety Rules.

Title	Definition
<i>Metalclad Switchgear Movable Earths</i>	Portable Primary Earth(s) applied to metalclad switchgear spouts before a Safety Document is issued.
<i>Potential Indicator</i>	A calibrated and tested portable voltage indicating device listed on ENA Approvals List G9 used for the purpose of indicating the presence of High Voltage .

3 DANGERS

The **System Danger(s)** to personnel working on metalclad switchgear are electrocution, burns and effects on eyes, arising from:-

- Gaining access to **Live** conductors
- The application of **Earthing Device(s)** to **Live Equipment**
- The incorrect sequence and method of application or removal of **Earthing Device(s)**

NSI 3
4.1 to 4.3

4 Control of Access to Spouts

- 4.1 Individuals shall not allow any part of their body or objects to be inserted into the spouts of metalclad switchgear. The only exceptions are:
- Once safety precautions have been established, use of a *Potential Indicator* to prove that the spout(s) are not **Live**.
 - Application of *Metalclad Switchgear Moveable Earths*
 - An appropriate **Safety Document** has been issued
- 4.2 All spout orifice shutters that are not required for immediate access shall be **Locked** in the closed position, unless inaccessible.
- 4.3 Where work is to take place on a circuit breaker or a voltage transformer within the switch room, which has been withdrawn, the orifice shutters of any spouts which are or may become **Live**, shall, in addition to the requirements of 4.2, be secured with **Danger** notices.

Guidance
NSI 3
4.1 to 4.2

4 Control of Access to Spouts

- 4.1 Due to the design of metalclad switchgear the **HV** conductors within spouts are encapsulated by earthed metalwork. Therefore are not classed as an exposed **HV** conductor for the purpose of **Safety Distance**. Therefore the approach to the **HV** conductor is controlled by access to the spouts.

The *Potential Indicator* shall be proved for correct operation using the proving unit supplied before and after each use



Figure 4.1A - Potential Indicator (SEAWARD KD1E/33) and Proving Unit

- 4.2 It is a principle of operating and working on metalclad switchgear that spouts not required for immediate access, e.g. for work or during operational and safety switching, shall be **Locked** shut.

This is the principal control measure in preventing access to **Live** spouts. The shutters can be made inaccessible by a circuit breaker selected to the service position.

Danger notices are as defined in Management Procedure NSI 6 "Demarcation in Substations".

NSI 3
5.1 to 5.8

5 Work on the Busbar Spouts, Busbars and Busbar connections of a Multi-Panel Switchboard

5.1 The section of busbars on which work is to be carried out shall be **Isolated** at all points at which it can be made **Live**, including any voltage transformers and **Point(s) of Isolation** shall be established.

5.2 Where duplicate circuit breakers are in one tank or on-load busbar selector isolators are installed, and it is impossible to isolate them from all points of supply, then all switches that can be closed onto the busbars on which work is to be carried out shall be rendered inoperative by having their mechanisms **Locked** in the open position.

5.3 **Primary Earth(s)** shall be applied on the busbar being worked on at a panel other than that on which work is to be carried out.

5.4 When working on busbar spouts, *Metalclad Switchgear Moveable Earths* shall, where reasonably practicable be applied to the panel where work is undertaken. These shall be applied by the **Senior Authorised Person** prior to the issue of the **Safety Document**.

The recipient of the **Safety Document** shall remove one phase at a time during the course of the work. Each phase removed shall be replaced by the **Safety Document** recipient before another phase is removed.

5.5 Where *Metalclad Switchgear Moveable Earths* are not available or will prevent the work from being carried out by inhibiting access, the **Senior Authorised Person** shall prove each spout is not **Live** using a *Potential Indicator* immediately prior to the issue of the **Safety Document**.

5.6 An appropriate **Safety Document** shall be issued.

5.7 Where work is to be carried out on the busbars or busbar connections, the **Senior Authorised Person** shall determine where access is to be made. The **Competent Person** shall then remove the appropriate cover plates under **Personal Supervision** of the **Senior Authorised Person**.

5.8 The **Senior Authorised Person** shall where practicable, prove that each busbar connection is not **Live** in the working area using a *Potential Indicator*.

Guidance
NSI 3
5.1 to 5.2

5 Work on the Busbar Spouts, Busbars and Busbar Connections of a Multi-Panel Switchboard

5.1 Safety switching on metalclad switchgear is covered by Management Procedure NSI 1 “Operational and Safety Switching”.

Point(s) of Isolation on this type of **Equipment** is established at the relevant spout orifice shutters using the principle of the point at which the **Equipment** being worked on can be made **Live**.

Note: For work on busbar spouts of a multi-panel switchboard, the **Point(s) of Isolation** are all the busbar shutters on that busbar, not the circuit spouts, voltage transformer spouts or spouts of the other busbar for duplicate busbar installations.

Front Bus



Figure 5.1A – Points of Isolation on Busbar Shutters

5.2 Duplicate Circuit Breakers in One Tank

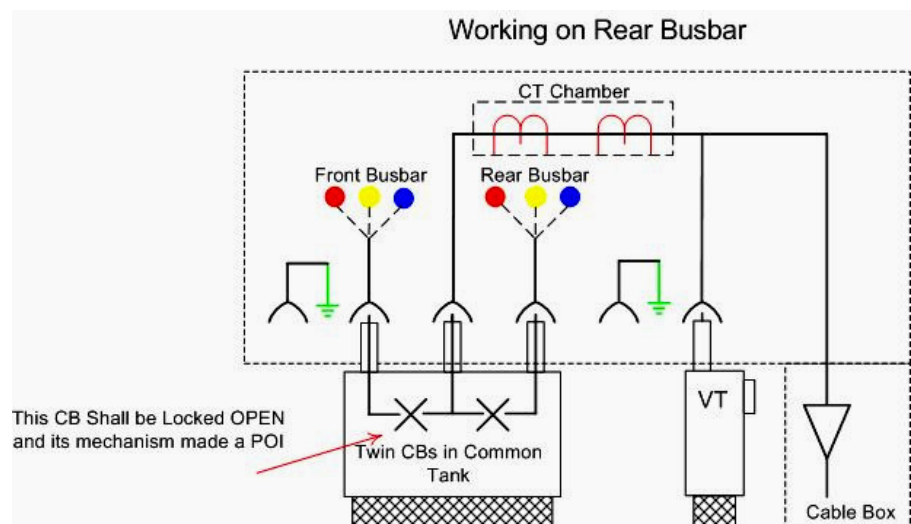

Figure 5.2A – Duplicate CBs in One Tank

Guidance
NSI 3
5.3 to 5.4

5.3 Where the design of the metalclad switchgear features integral earthing, the circuit breaker shall be used where practicable to provide an earth on the busbar. This will normally be at the bus section or bus coupler bay position. Where the use of a circuit breaker is not practicable or where the design of the switchgear does not allow for this, *Metalclad Switchgear Moveable Earths* may be used to provide an earth on the busbar. The spouts shall first be proved not **Live** by means of a *Potential Indicator*.

Where work is required on all busbar spouts of a busbar section and **Primary Earth(s)** prevent access to one panel, the **Safety Document** shall be cancelled and the **Primary Earth(s)** moved to another panel. A new **Safety Document** shall then be issued.

5.4 Prior to the application of *Metalclad Switchgear Moveable Earths*, where practicable it shall be proven that the spouts are not **Live** by the use of a *Potential Indicator*.

There are different designs of *Metalclad Switchgear Moveable Earths*. Some take the form of a simple test bushing, which screws into the spout orifice and may or may not be rated to withstand **HV** for test purposes. Other types are based on a truck design which is racked into the service position and an earthing mechanism is operated via a spring.

Metalclad Switchgear Moveable Earths shall be visually inspected for damage prior to application and the earth end connected first and removed last.



Figure 5.4A - *Metalclad Switchgear Moveable Earths*



Figure 5.4B – *Test Bushings for Metal Clad Switchgear*

Guidance
NSI 3
5.4 Cont: to 5.7



Figure 5.4C – Earth Connection Applied First to Bottom

- 5.5 Work where *Metalclad Switchgear Moveable Earths* would prevent access might include removal of shutters or shutter mechanisms, repair of spout orifice lips or capacitive tap connections.
- 5.7 As there is a risk that the incorrect cover plates could be removed and that access may be made to **Live** connections, **Personal Supervision** is required during the removal of cover plates by a **Senior Authorised Person**.

NSI 3
6.1 to 6.2

6 Work on Feeder Spouts, Voltage Transformer Spouts and Single Panel Busbar Spouts and Associated Connections

6.1 Work on associated connections:

- (a) The associated connections shall be **Isolated** at all points at which they can be made **Live**, including any voltage transformers. **Point(s) of Isolation** shall be established.
- (b) **Primary Earth(s)** shall where practicable be applied between the **Point(s) of Isolation** and the connections to be worked on.
- (c) An appropriate **Safety Document** shall be issued.
- (d) Where work is to be carried out on the associated connections, the **Senior Authorised Person** shall determine where access is to be made. The **Competent Person** shall then remove the appropriate cover plates under **Personal Supervision** of the **Senior Authorised Person**.
- (e) The **Senior Authorised Person** shall where practicable, prove that each associated connection is not **Live** in the working area using a *Potential Indicator*.

6.2 Work on Spouts:

- (a) The spouts on which work is to be carried out shall be **Isolated** at all points at which they can be made **Live**, including any voltage transformers. **Point(s) of Isolation** shall be established.
- (b) **Primary Earth(s)** shall where practicable, be applied between the **Point(s) of Isolation** and the spouts to be worked on.
- (c) When it is not practicable to apply **Primary Earth(s)** between the **Point(s) of Isolation** and the spouts or when the **Primary Earth(s)** would prevent access to the point of work the following shall apply:
 - (i) *Metalclad Switchgear Moveable Earths* shall, where reasonably practicable be applied to the spouts where work is undertaken. These shall be applied by the **Senior Authorised Person** prior to the issue of the **Safety Document**.

The recipient of the **Safety Document** shall remove one phase at a time during the course of the work. Each phase removed shall be replaced by the **Safety Document** recipient before another phase is removed.

An appropriate **Safety Document** shall be issued.

NSI 3
6.2 Cont: to 6.3

- (ii) Where *Metalclad Switchgear Moveable Earths* are not available or will prevent the work from being carried out by inhibiting access.

An **Earthing Device** shall be applied to the spouts to be worked on and a **Sanction for Work** shall be issued.

- 6.3 Where there is a risk of induced voltages, **Drain Earth(s)** shall where reasonably practicable, be connected at the nearest point, to the point of work, where access to the conductors can safely be obtained.

Guidance
NSI 3
6.1

6 Work on Feeder Spouts, Voltage Transformer Spouts and Single Panel Busbar Spouts and Associated Connections

Single-panel switchboards are rare in National Grid. A typical example would be an extensible panel board used as part of site auxiliary (3.3kV – 11kV) supplies. In the case of a ring main unit the ring switches can be locked in the open position and established as **Point(s) of Isolation**.

- 6.1 Safety switching on metalclad switchgear is covered by Management Procedure NSI 1 “Operational and Safety Switching”.

Point(s) of Isolation on this type of **Equipment** is established at the relevant spout orifice shutters using the principle of the point at which the **Equipment** being worked on can be made **Live**.

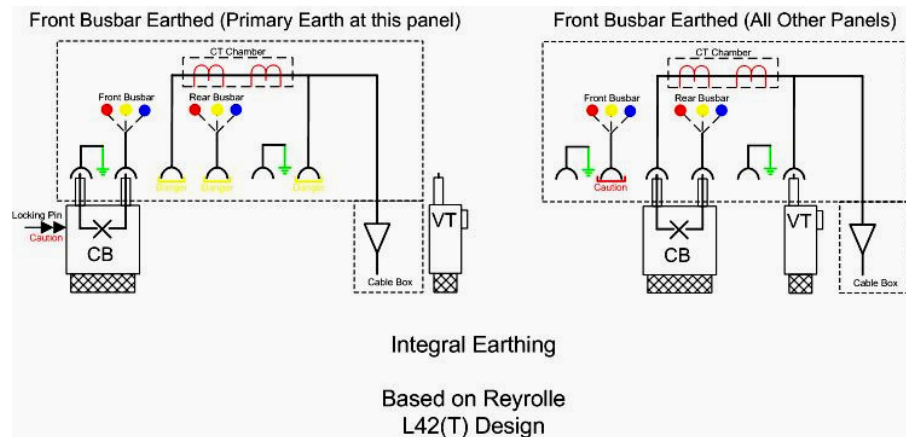

Figure 6.1A – Points of Isolation on Busbar Shutters

- 6.1d As there is a risk that the incorrect cover plates could be removed and that access may be made to **Live** connections, **Personal Supervision** is required during the removal of cover plates by a **Senior Authorised Person**.

Guidance
NSI 3
6.2

6.2 Safety switching on metalclad switchgear is covered by Management Procedure NSI 1 "Operational and Safety Switching".

Point(s) of Isolation on this type of **Equipment** is established at the relevant spout orifice shutters using the principle of the point at which the **Equipment** being worked on can be made **Live**.

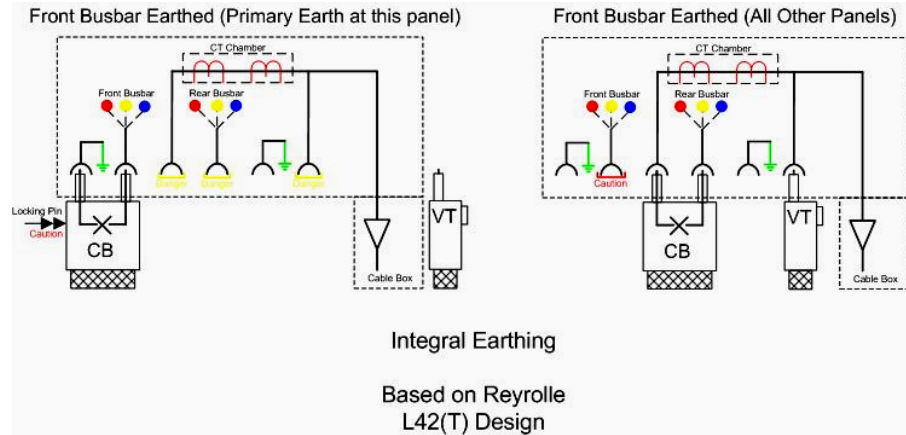

Figure 6.2A – Points of Isolation on Busbar Shutters

6.2ci Refer to guidance Section 5.4.

6.2cii **Primary Earths** applied to the spouts will demonstrate that the spouts in question are not **Live** and have been discharged. A **Sanction for Work** can then be issued to enable removal of the **Primary Earth** applied to the spouts to be worked on.

NSI 3
7.1 to 7.4

7 Work on a Circuit Breaker or Voltage Transformer

- 7.1 When work is carried out on a circuit breaker or voltage transformer which has been removed from its service position, electrically discharged, and transported to a workshop or similar area, the formal requirements of the safety rules do not apply.
- 7.2 If the work is to be carried out in the switchroom or enclosure where the fixed portion of the switchgear is situated, the shutters of any spouts which are, or may become, **Live** shall be **Locked** shut.
- 7.3 **Danger** notice(s) shall be attached where applicable on or near to the **Live Equipment** at the limits of the work area.
- 7.4 The **Senior Authorised Person** shall assess the means of achieving **Safety from the System**.

Guidance
NSI 3
7.1 to 7.4

7 Work on a Circuit Breaker or Voltage Transformer

- 7.1 Access to spouts shall be controlled as per Section 4.3.
- 7.2 Since the switch board will be **Live**, it is important that shutters are immediately **Locked** shut as this is the main control measure to prevent access to **Live** spouts in the work area.
- 7.4 The **Senior Authorised Person** shall assess the extent and nature of the work and the hazards present. Instructions can be confirmed by the issue of a **Limited Access Certificate** and / or detailed in risk assessment and method statement.

A **LV Permit for Work** would normally only be required if the isolation of **Low Voltage (LV)** and mechanical supplies are necessary in addition to that isolation brought about by removing the circuit breaker or voltage transformer from the service position.

It is important to note that spout orifice shutters **Locked** shut for this work are not considered as **Point(s) of Isolation**, but as a physical barrier to avoid **System** derived hazards. The **Key(s)** for any shutters shall be **Locked** in a **Key Safe**.

When work requires operation of the circuit breaker this can be carried out either using the slow-closing jack or via the **LV** trip and close supplies. Since the **Control Person (CPS1)** will not have consented to a **Safety Document**, formal agreement to operate the circuit breaker via an "Operate As Required" shall be obtained from the appropriate **Control Person**.

Guidance
NSI 3
7.4 Cont:



Figure 7.4A - OCB Withdrawn and Umbilical Removed

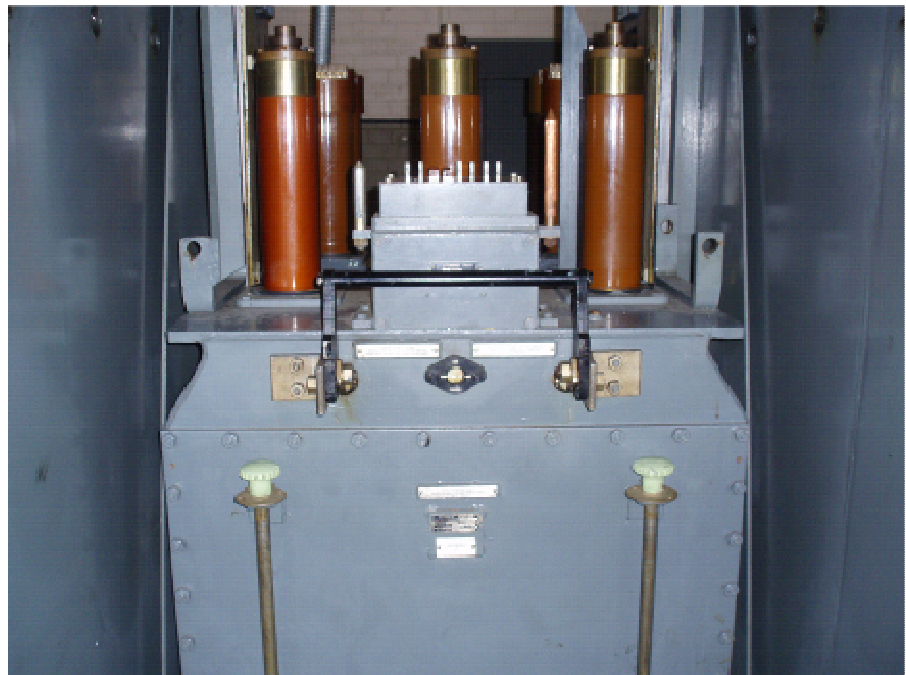

Figure 7.4B - Voltage Transformer Withdrawn

Note: the primary (rear) and secondary (front) connections are automatically broken by withdrawing the VT

Guidance
NSI 3
7.4 Cont:

Work to take place under:
LAC
Oral Instructions
Personal Supervision

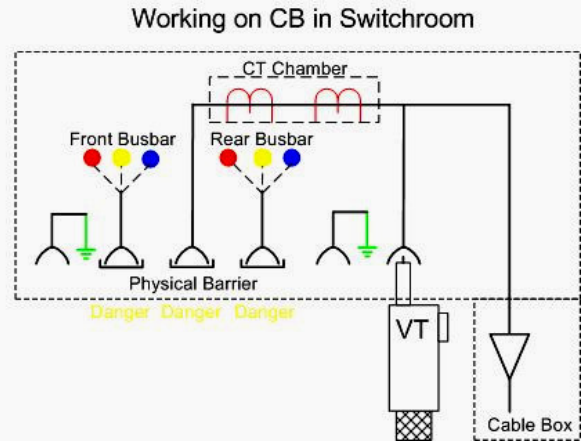
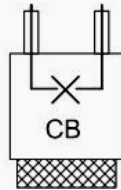

Figure 7.4C Working on Withdrawable HV Equipment in the Switchroom

Appendix A - Authorisation Matrix for Contractors Personnel

Contractor Personnel	Person	Competent Person	Authorised Person	Senior Authorised Person
Sections	N/A	N/A	N/A	N/A

Contractors Personnel

Contractors by law have a duty to provide a safe system of work for their employees.

National Grid have a duty in law to employ competent Contractors to undertake work on metalclad switchgear and provide them with relevant safety information to enable them to develop their own safe systems of work.

National Grid Supply Chain Management processes ensure competent Contractors are selected.

Once a competent Contractor is selected, National Grid has a duty to ensure the Contractor understands **Danger(s)** associated with undertaking work within an **HV** switchroom or compound, permit systems, demarcation and safe access and egress, including movement of objects and vehicles etc. This is accomplished by Contractors employees being authorised to National Grid Safety Rules and to NSI 6 and 8, via Management Procedure - NSI 30 "Appointment of Persons".

The Contractor selected shall be an expert in the area of **HV Metalclad Switchgear with spouts** and therefore there is no requirement for authorisation under NSI 3.

Before a **Safety Document** is issued the **Senior Authorised Person** shall be authorised to NSI 3 and shall ensure the Contractors risk assessment and method statements cover the **Danger(s)** identified in NSI 3.

The National Grid **Senior Authorised Person** will issue a **Safety Document** to a Contractors **Competent Person** authorised to NSI 6 & 8.

Note: If the work involves the application of **Drain Earth(s)** the Contractors **Competent Person** shall be authorised to Management Procedure - NSI 2 "Earthing High Voltage Equipment", or the **Senior Authorised Person** shall manage the **Drain Earth(s)** via the **Safety Document** transfer process.