

**CUSC Section 15
(CMP192)
User Commitment
Methodology**

**Guidance and
Implementation Document**

February 2013 Version 0.1

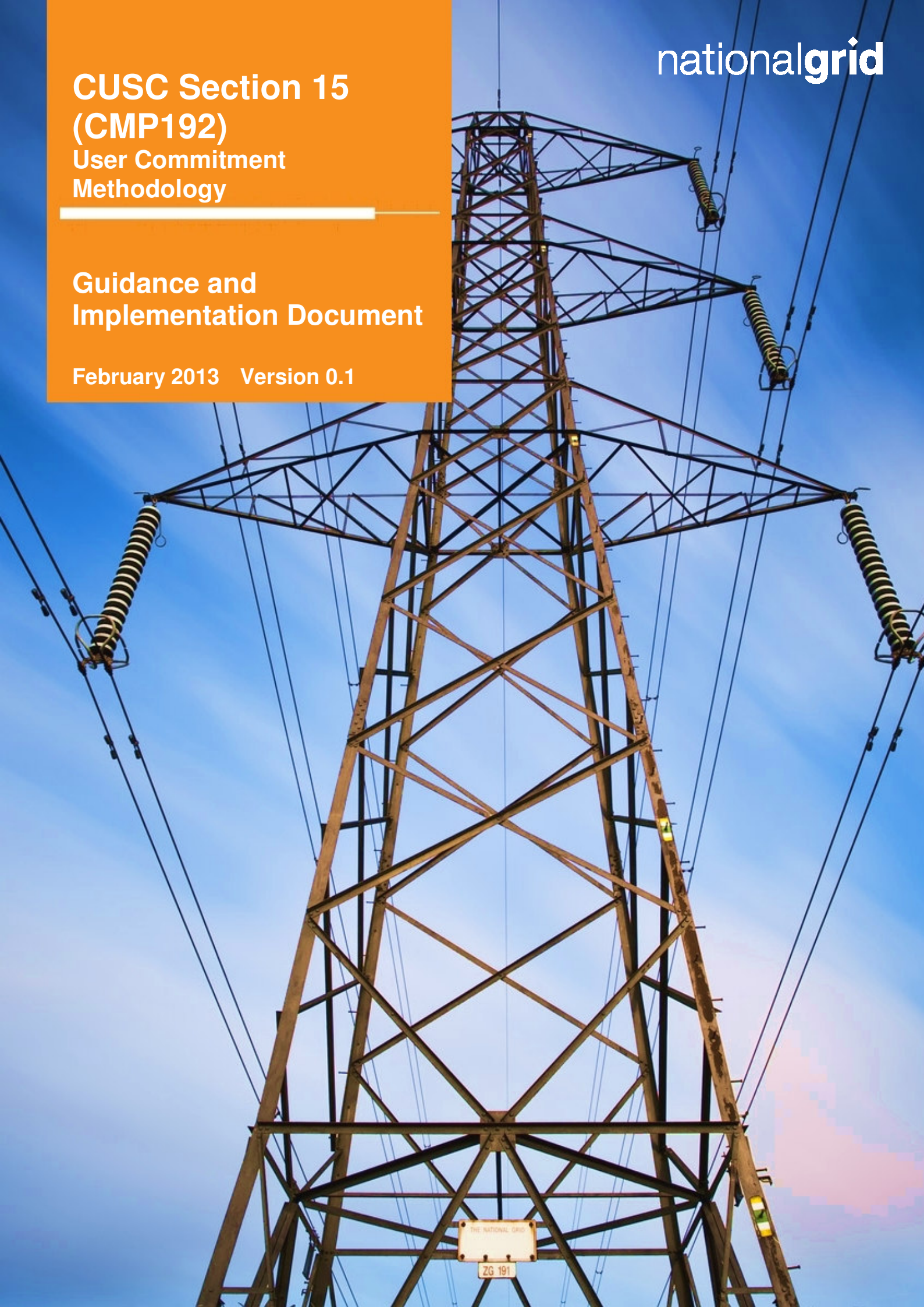

| | |
|---|----|
| 1. Summary | 3 |
| 2. Purpose of the document | 3 |
| 3. Background..... | 4 |
| 4. Attributable and Wider Transmission works | 5 |
| 5. Calculating liabilities | 9 |
| 6. Liability profile | 13 |
| 7. Security..... | 16 |
| 8. Termination, closure and capacity reduction..... | 17 |
| 9. Date Changes..... | 18 |
| 10. CUSC..... | 18 |
| 11. Offshore arrangements..... | 20 |
| 12. Embedded Generation | 21 |
| 13. Non Generation User commitment..... | 21 |
| 14. Transition of existing pre commissioning generation | 22 |
| 15. New applicants | 23 |
| 16 . Frequently asked questions..... | 24 |
| 16. Version Control | 31 |

1. Summary

New arrangements for generation user commitment have been codified in the Connection Use of System Code (CUSC) as a result of the CUSC modification Proposal (CMP) 192. The proposal was raised by NGET in February 2011 and approved by Ofgem on 30 March 2012.

The new arrangements will replace the current interim Final Sums methodology and the Interim Generic User Commitment Methodology (IGUCM) for generators, and will take effect from 1 April 2013. The proposal was based on incentivising generation projects to provide notice of cancellation, closure and capacity reduction in a timely manner such that inefficient transmission investment by the transmission owners can be minimised, whilst reducing the barrier to new entrants that such arrangements represent.

The new arrangements are formally set out in section 15 of the CUSC and comprise of a generic liability to cover broad system investment (Wider), and a specific liability to cover local generator-driven investment (Attributable). All generation projects would be liable for a proportion of the wider amount, whilst only pre-commissioning generation projects would be liable for their particular attributable amount. In calculating the liabilities, the methodology includes a number of factors to more accurately reflect the risk of inefficient or stranded assets, and avoid over-securitisation of new investments. These factors cover sharing risk with consumers, potential for asset reuse by Transmission Owners (TO), catch-up investment, etc. Security for this liability will reduce for pre-commissioning generation projects as their project progresses to completion, whilst no security will be required for post-commissioning users (as per current CUSC arrangements).

Impact of the change

The new arrangements take effect on 1 April 2013. Pre commissioning generation will be transitioned to the new arrangements ahead of this date and will be given updated contracts with the choice of fixed or actual liabilities.

2. Purpose of the document

This document has been written to provide guidance to customers about how the new arrangements impact their generation projects and how the new arrangements will be implemented ahead of 1 April 2013. Part 14 of this document includes a plan describing the key milestones.

This guidance document has been written to aide understanding and does not in anyway override/supersede any provisions within CUSC or any individual connection agreements, and the provisions and interpretation of the CUSC takes precedence

Version 2

This document has been updated in line with feedback received from customers during the transitional period. The version control on page 31 details any changes or additions between versions; the key changes since the last edition of the guidance document are provided below:

- Definitions for Attributable Works and MITS
- Attributable Liability Factors
- Wider Tariff Examples
- Distance Factor
- Key Consents
- New sections for TEC & Date Changes
- New Appendices Descriptions
- Additions to Frequently Asked Questions.

If you have any feedback or questions in respect of any part of this guidance document or any aspect of the new arrangements not covered in the document, we would welcome your engagement and encourage you to discuss this with your Customer Agreement Manager or via the email address below;

transmissionconnections@nationalgrid.com

3. Background

NGET and the other Transmission Owners (TOs) undertake investment works to accommodate the needs of generators already connected and those expected to connect in the future to the electricity transmission network. However, a generator may decide to cancel its project or reduce its capacity after the associated works have already begun. This may result in unnecessary costs to other network users, which are ultimately borne by the end consumer. User commitment arrangements place liabilities on generators triggering particular investment works, in order to financially secure the investment being undertaken on their behalf.

User commitment performs a vital function in ensuring adequate information is available to TOs to plan and develop the network in a manner that is economical and efficient, and protects the interests of consumers and wider industry. User commitment signals are also financially underwritten to incentivise the provision of accurate and timely information and to ensure that the risk of stranded assets is placed on those parties best placed to mitigate and manage the risk.

Existing arrangements were cited as a barrier to entry, particularly for smaller parties. The arrangements for generators already connected to the transmission system, differ significantly from the arrangements for generators that are awaiting connection. The existing arrangements were lacking the required transparency, as they were not detailed in Connection and Use of System Code (CUSC), and there were interim amendments which were introduced to accommodate the issues detailed above.

In February 2011 NGET proposed a modification to the CUSC to introduce enduring User commitment arrangements. The proposal was further developed by the industry, with the final approval¹ being given by Ofgem. The User Commitment methodology introduced by CMP192 was implemented into a new section of the CUSC (Section 15)² on 30 March 2012, with an effective date of 1 April 2013.

The new User Commitment Methodology replaces the existing interim security methodologies from 1 April 2013. This includes both Final Sums³ and the Interim Generic User Commitment Methodology (IGUCM)⁴.

¹ <http://www.nationalgrid.com/NR/ronlyres/4386A099-44CF-467A-AD2C-882C1AE3DACC/52833/CMP192D.pdf>

² <http://www.nationalgrid.com/NR/ronlyres/2561685B-659F-4E6C-9CB8-AE74AEE582FD/52985/CUSCSection15v1031March2013.pdf>

³ http://www.nationalgrid.com/NR/ronlyres/6302C1A3-B7B5-42BF-9054-81B4AFA858F5/42130/SecuritiesConsultationReportv1Final_PDF.pdf

⁴ <http://www.nationalgrid.com/NR/ronlyres/B719C93E-01EC-4CA8-BF52-D3C180C200D5/35852/InterimGenericUserCommitmentMethodologyStatements.pdf>

4. Attributable and Wider Transmission works.

The new arrangements comprise a generic liability to cover broad system investment (Wider), and a specific liability to cover local generator-driven investment (Attributable). All generation projects would be liable for a proportion of the wider amount, whilst only pre-commissioning generation projects would be liable for their particular attributable or local amount. This part of the guidance document explains the differences between the two categories.

Attributable

Attributable Investment is driven directly by the connection of new generation and therefore the risk should be placed 100% on generation and not shared with demand.

Attributable works are those works in a construction agreement that directly relate to a generator being connected to the transmission network. This includes the works up to and including those at an existing Main Integrated Transmission System (MITS).

Definition of Attributable works

“Those components of the Construction Works which are required (a) to connect a Power Station which is to be connected at a Connection Site to the nearest suitable MITS Node; or (b) in respect of an Embedded Power Station from the relevant Grid Supply Point to the nearest suitable MITS Node (and in any case above where the Construction Works include a Transmission substation that once constructed will become the MITS Node, the Attributable Works will include such Transmission substation) and which in relation to a particular User are as specified in its Construction Agreement”

Definition of MITS

Attributable works are defined as the works required to connect the generator to an existing MITS (Main Integrated Transmission System) node, as defined in Section 11 of the CUSC. Section 11 defines MITS nodes as follows:

- Grid Supply Point (GSP) connections with 2 or more transmission circuits connecting at the site; or,
- Connections with more than 4 transmission circuits connecting at the site.

A Grid Supply Point is defined in Section 11 of the CUSC as being a point of delivery from the National Electricity Transmission System to a Distribution System or a Non-Embedded Customer;

For the avoidance of doubt the existing MITS is a MITS already in existence at the time a generator is made an offer.

MITS maps

A map of the GB Existing Transmission System which includes 132kv, 275kv and 400kv substations is currently available in Appendix A1 of the Electricity Ten Year Statement⁵.

The MITS can be identified on the above map by identifying substations with more than 4 transmission circuits or a GSP with at least 2 transmission circuits. Any GSP with more than 2 transmission circuits is identified by the visibility of circuits that go from a higher to lower value (or vice versa) due to connecting to a DNO or Embedded Customer. Examples are provided below:

⁵ <http://www.nationalgrid.com/uk/Electricity/ten-year-statement/current-elec-tys/>

Examples of MITS

Example 1, Single MITS, more than 4 transmission Circuits

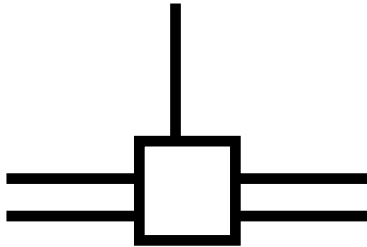

Example 2, Grid Supply Point (GSP) connections with 2 or more transmission circuits

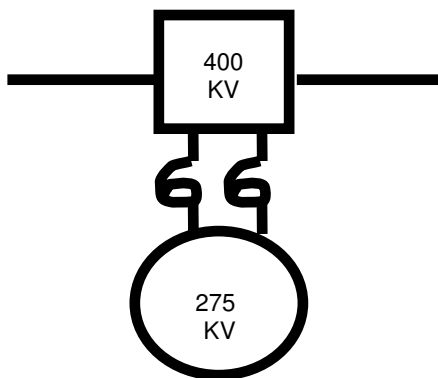

Example 3, Generator connecting to Multiple MITS

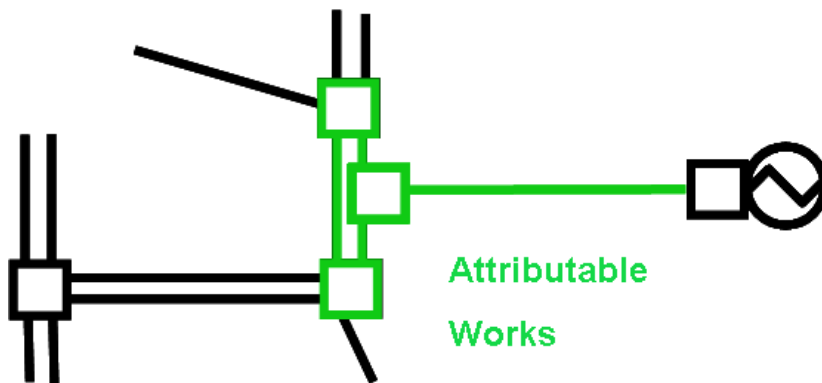

Wider

Both generation and demand drive the requirement for wider transmission investment and therefore the risk of any wider investment being inefficiently incurred should be shared 50/50 between Generation and Consumers.

Wider works in this context are the works that are not categorised as Attributable (ie the works on the MITS).

Sharing of Risk

- The liability for Attributable works is borne 100% by generation.
- The liability for wider system investment is shared 50/50 between generation and consumers.

| | Generation | Consumers |
|--------------|------------|-----------|
| Attributable | 100% | 0% |
| Wider | 50% | 50% |

Definitions of Attributable and Enabling

In discussions with customers regarding CUSC Section 15, clarity was sought regarding the differences between Attributable Works, and the Enabling Works that form part of Connect and Manage⁶.

Enabling Works are the minimum transmission reinforcement works which need to be completed before a generator can be connected to, and given firm access to, the transmission system. This must include criteria to allow the system to be operated in a safe manner and without incurring excessive costs. Attributable Works do not factor in this criteria; for clarity, Enabling Works will be in a Construction Agreement Appendix H and Attributable Works will be in a Construction Agreement Appendix MM.

In some cases it is likely that the Enabling Works will be the same as the Attributable Works, however in some circumstances (eg long radial parts of the network), Enabling Works may be required to be greater than the works necessary to connect to the MITS. In other circumstances where there is sufficient diversity of operations, it is possible that Enabling Works will be less than the works necessary to connect to the MITS, and therefore less than the Attributable Works. Examples of Enabling vs. Attributable Works are given on the following page.

For the avoidance of doubt, the definitions of works used in the new arrangements under CUSC Section 15 do not replace or impact the definition of Enabling Works introduced by Connect and Manage.

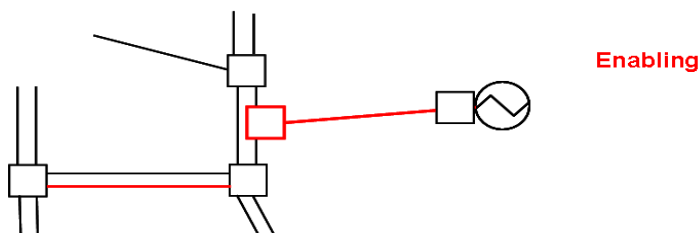

⁶ <http://www.nationalgrid.com/NR/rdonlyres/01463C70-F178-4930-9A00-780FE5330F2D/47332/CMversion50.pdf>

Pre and Post Commissioning

The aim of the new arrangements in CUSC is to incentivise future generation projects (pre commissioning) to provide notice of cancellation in a timely manner, and for existing generation projects (post commissioning) to provide notice of closure or capacity reduction, in a timely manner. This will enable inefficient transmission investment by the transmission owners to be minimised.

Both pre and post commissioning generation projects may have an impact on decisions for new Transmission investment. The addition of new generation (pre commissioning) to the National Electricity Transmission System (NETS), and the closure of existing generation (post commissioning) has an equal and opposite effect on the need for network capacity. The cancellation of a pre-commissioned Power Station could affect attributable and wider transmission system investment decisions, and the closure of a post-commissioned generation project will only affect new wider transmission system investment decisions. The new arrangements in CUSC focus on information to assist transmission companies to efficiently manage ongoing new investments on the transmission system, and hence avoid under-utilisation of assets.

- The liability for pre-commissioning generation projects takes account of transmission investment for attributable and wider works; and
- The liability for post-commissioning generation projects takes account of the investment for wider works only.

| | Pre | Post |
|--------------|-----|------|
| Attributable | Yes | No |
| Wider | Yes | Yes |

5. Calculating liabilities

The liabilities for both the Wider and Attributable works are calculated differently. The Wider Liability is generic and covers investment on the wider transmission system. The attributable liability is specific to the local investment driven by the connection of new generation projects. Examples of these are set out below.

Wider Liability

The wider liability is a zonal £/MW charge. The charges are to be published annually and are calculated from the apportionment of wider load related and non load related Capex across system boundaries, which are then mapped to generation zones. This process is broken down into the following four steps:

Step 1 - Each Transmission Owner (TO) provide the load related and non load related Capex for the next four years to give the total wider value at risk (VAR).

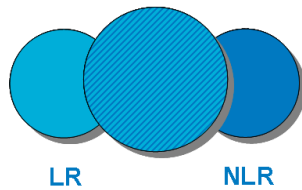

Step 2 – The wider VAR is then reduced by two factors

- the User Risk Factor (URF) 50%. This factor accounts for the 50/50 share between generation and consumers described in part 4 of this document; and
- the Global Asset Reuse Factor (GARF) 33%. This value is fixed and represents the transmission assets which a TO could potentially reuse on another project.

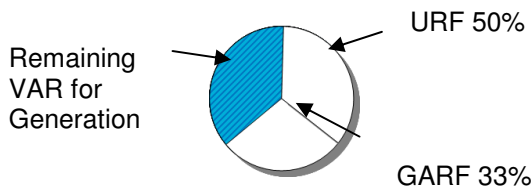

Step 3 – Remaining VAR is then apportioned by boundaries and mapped to Generation Zones by reference to the following table (taken from Table F1.1 of the Electricity Ten Year Statement (ETYS)⁷):

| Boundary No | Boundary Name | Licensee | Zone Numbers |
|-------------|-------------------------------|----------------------|--|
| B1 | North West | SHE Transmission | Z1 |
| B2 | North-South | SHE Transmission | Z1, Z2 |
| B3 | South West | SHE Transmission | Z3 |
| B4 | SHETL-SPT | SHE Transmission/SPT | Z1, Z2, Z3, Z4 |
| B5 | North-South | SPT | Z1, Z2, Z3, Z4, Z5 |
| B6 | SPT-NGET | SPT/NGET | Z1, Z2, Z3, Z4, Z5, Z6 |
| B7 | Upper North-North | NGET | Z1, Z2, Z3, Z4, Z5, Z6, Z7 |
| B8 | North to Midlands | NGET | Z1, Z2, Z3, Z4, Z5, Z6, Z7, Z8, Z9 |
| B9 | Midlands to South | NGET | Z1, Z2, Z3, Z4, Z5, Z6, Z7, Z8, Z9, Z10, Z11 |
| B10 | South Coast | NGET | Z16, Z17 |
| B11 | North East & Yorkshire | NGET | Z1, Z2, Z3, Z4, Z5, Z6, Z7, Z8 |
| B12 | South & South West | NGET | Z13, Z16, Z17 |
| B13 | South West | NGET | Z17 |
| B14 | London | NGET | Z14 |
| B15 | Thames Estuary | NGET | Z15 |
| B16 | North East, Trent & Yorkshire | NGET | Z1, Z2, Z3, Z4, Z5, Z6, Z7, Z8, Z10 |
| B17 | West Midlands | NGET | Z11 |

⁷ http://www.nationalgrid.com/NR/rdonlyres/3CB470F1-1A12-4EDE-A34C-000FF051C37B/57732/ETYS_2012_Appendix_F.xls

Step 4 – An annual statement of zonal wider liabilities is published on the NGET Website.

2013/14 Cancellation Charge Tariff Statement

| Zone | Tariff (£/MW) |
|------|---------------|
| Z1 | 29,221.20 |
| Z2 | 21,624.46 |
| Z3 | 18,200.85 |
| Z4 | 16,358.15 |
| Z5 | 10,305.45 |
| Z6 | 9,885.35 |
| Z7 | 6,722.85 |
| Z8 | 3,216.11 |
| Z9 | 1,455.89 |
| Z10 | 1,196.99 |
| Z11 | 1,857.54 |
| Z12 | 959.31 |
| Z13 | 654.03 |
| Z14 | 959.31 |
| Z15 | 342.67 |
| Z16 | 1,973.64 |
| Z17 | 6,553.22 |

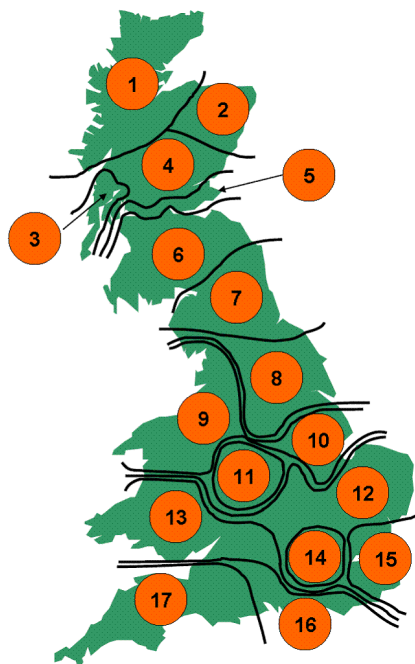

To summarise, the generic wider liability is a zonal cancellation charge calculated by apportioning each Transmission Owner's (TO) wider Capex into the 17 zones in the Electricity Ten Year Statement (ETYS). These are the same zones as previously published in the in the Seven Year Statement (SYS).

The apportionment of wider Capex to each ETYS zone is based on the following factors.

| Input | Source/Fixed Factor | Description |
|---------------------------------|------------------------|--|
| User Risk Factor | 50% | Share of the wider risk between generation and consumers. |
| Global Asset Reuse Factor | 33% | Percentage of the wider transmission assets which a TO could potentially reuse on another project. |
| Boundary levels | Nov 12 ETYS | Depth of each SYS boundary multiplied by the increase in required capability on that boundary. |
| Boundary non compliance factors | Nov 12 ETYS | Ratio between available capacity and required capability on each boundary. |
| Generation base | Nov 12 Generation Base | Current and Future Generation by zone. |
| Wider Capex data | April 2012 RIIIO T-1 | Sum of TO Capex excluding any attributable works cost. |

Please note that the Seven Year Statement (SYS) has been replaced by the Electricity Ten Year Statement (ETYS) which is available at:

<http://www.nationalgrid.com/uk/Electricity/ten-year-statement/current-elec-tys/>

Attributable Liability

The Attributable liability will be calculated bi-annually and will be specific to the components that make up the attributable works. Components are considered to be substations or lengths of cable or overhead line between substations (and not the individual assets making up that component). The process is broken down in the steps below;

Step 1 - Each Transmission Owner (TO) provide for each component, the total Capex estimate and the current estimate of cancellation amount for the next 6 month security period to give the total Value at Risk (VAR) per component.

Step 2 – The Attributable VAR for each component is then reduced by 3 Factors (where appropriate).

Strategic Investment Factor (SIF)

- This factor limits the attributable liability to the proportion of the investment that the generator has triggered. This factor ensures the generator isn't liable for more than their proportion should the TO build a component with greater capability than the generator requires. This also removes the volatility of previous sharing arrangements, where the actions of another generator could significantly impact the liability of another generator.

$$SIF = \frac{Generator_Capabilty_ (MW)}{Component_ Capabilty_ (MW)}$$

Example: 500 MW Power Station and TO building a component capability of 2000 MW.

$$SIF = \frac{500}{2000} = 0.25$$

Local Asset Reuse Factor (LARF)

- For each attributable component listed by a TO, the LARF is an estimate of what percentage of the component could be reused, should the attributable generator cancel their project. This percentage is an average representation of the ability to reuse any part of the component over the whole of the construction period. These factors will be linked to the component type, unless the TO considers that the design of the component is suitably different from the norm.

The LARF is an approximation of asset reuse and does not vary through the construction programme. As part of the implementation programme, we had hoped that a table of reuse factors for standard components would be published in this guidance document. However, we now understand that an estimation of reuse will vary across TOs, and will be on a case by case basis. Going forward, we will review this based on tested and proven data on reuse, following reconciliation data if/when generation projects terminate.

Distance Factor

- Where the nearest suitable MITS is not the connection MITS, the attributable works distance factor will be the pro rata share of the transmission capacity to connect the generation project to the nearest suitable MITS, on the transmission network.
- The distance factor allows a TO to make design decisions, without exposing the attributable generation project to more than the minimum attributable works.
- This factor is only applicable for components where distance is relevant ie cables and overhead lines. This factor will be determined at the start of the project based on the estimated straight line distances, and will not be updated throughout the construction programme.

⁹ <http://www.nationalgrid.com/NR/rdonlyres/2561685B-659F-4E6C-9CB8-AE74AEE582FD/52985/CUSCSection15v1031March2013.pdf>

- This factor was intended for offshore projects, however to transition all existing agreements to the new arrangements under CUSC, this has been applied universally.
- In some cases the MITS closet to the generation project is unsuitable, if for example the terrain makes the closest MITS uneconomical to connect to. The definition of Attributable however, is the nearest suitable MITS, and a TO will make the decision regarding the suitability. If there is a MITS that is closer and also suitable then the attributable works will be a prorata share.
- In transitioning the existing agreements to the new arrangements under CUSC, we have found that in all cases, that the nearest suitable MITS and the connection MITS, are the same.

Attributable component liability example:

$$\text{Component_VAR} \times \frac{\text{Generator_Capabilty_}(MW)}{\text{Component_Capabilty_}(MW)} \times (1 - \text{LARF}) = \text{Component_liability}$$

or;

$$£1,000 \times \frac{500}{1000} \times (1 - 0.4) = £300$$

Where;

| | |
|----------------------|----------|
| Component VAR | = £1,000 |
| Generator Capability | = 500MW |
| Component Capability | = 1000MW |
| LARF | = 40% |

6. Liability profile

This part of the guidance document breaks down how the Wider and Attributable liabilities are profiled, from the application for a pre commissioned generation project through to the closure or capacity reduction of a post commissioned generation project.

Trigger Date

Key to how the profile works is the trigger date. Other than in the scenario described below, the trigger date is three financial years prior to the financial year of connection; this will be 1 April of that financial year (as shown in the examples in the table below).

| Trigger Date | Completion Date |
|--------------|-----------------|
| 1 April 2014 | 31 October 2017 |
| 1 April 2015 | 20 April 2018 |

Where the completion date is changed by the generation project applying to delay completion, the Trigger date will not be amended in respect to the new completion date.

Where the Completion date is changed by the TO delaying the completion date, the Trigger date will be amended inline with the new completion date.

Wider Profile (Pre Commissioning)

For pre commissioning generation, the wider liability begins at the trigger date, and builds up from 25% of the wider liability to 100% in the year immediately before commissioning, as demonstrated below.

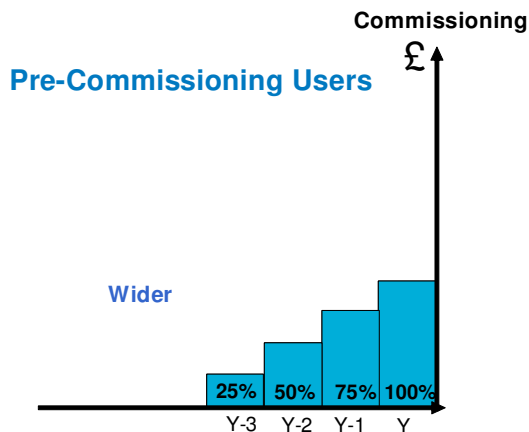

Wider Profile (Post Commissioning)

For post commissioning generation, the wider liability profile is driven by the notice period given prior to closure. With over two years notice, the liability will be 0% of the wider charge.

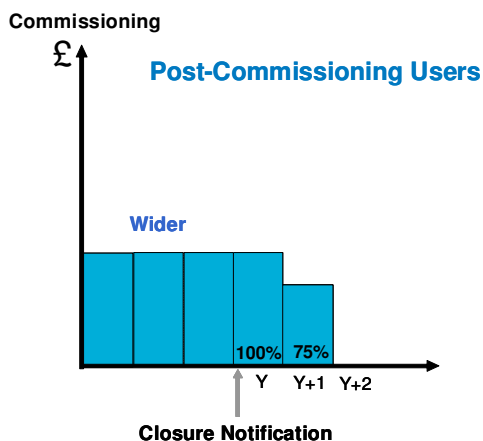

| Notice Given | % Wider Liability |
|--------------|-------------------|
| > 2 years | 0 |
| > 1 years | 75 |
| > 5 days | 100 |

Examples of a generator providing notice on 01/05/2013:

| Date Notice Provided | Effective | % Wider Liability |
|----------------------|------------|-------------------|
| 01/05/2013 | 01/05/2015 | 0 |
| 01/05/2013 | 06/05/2014 | 75 |
| 01/05/2013 | 31/10/2013 | 100 |

Attributable Profile

The attributable liability starts when a TO commits cost to the attributable assets. This liability will be provided bi-annually, and will give an estimate of the next bi-annual security period and the total Attributable Capex for each generation project.

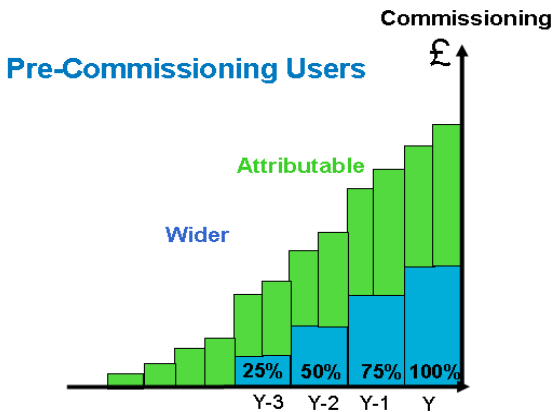

Total Profile

The table below demonstrates the full user commitment liability.

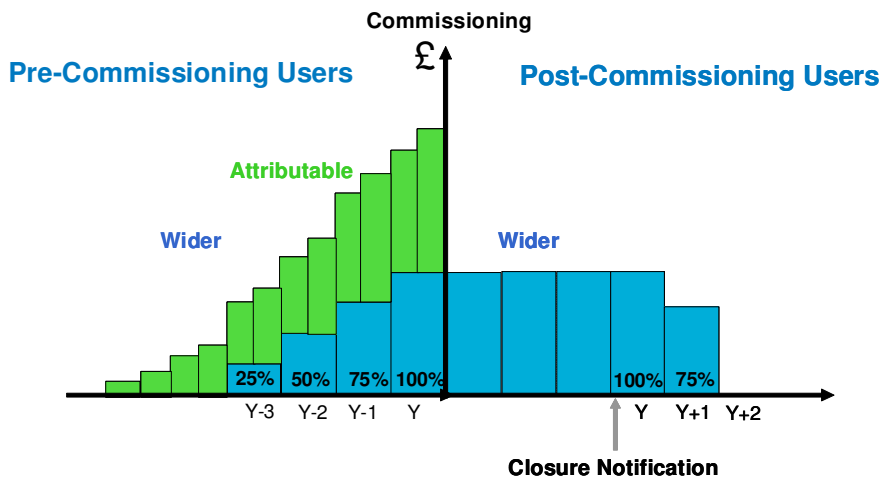

Actual or Fixed Attributable

Pre-commissioning generation projects will be given the choice to either fix their liability, or to receive a bi-annual update. This allows generation projects a full and transparent view of liabilities until commissioning. The bi-annual statements will reflect any changes to works up until the commissioning date. Those on a fixed liability will continue to receive bi-annual statements, although the liability amount will not change.

Pre commissioning generation projects, will be given the fixed or actual option upon transition to the new arrangements, and bi-annually thereafter until the fixed option is chosen.

Actual Security Profile

Unless generation projects opt for the fixed option, they will receive an updated statement bi-annually which will reflect the total liability, as well as the liability for the coming security period based on the TO expected expenditure up to that period.

Upon termination or capacity reduction whilst on the actual option, the attributable cancellation charge will be reconciled to reflect the actual TO spend as a result of that generation project.

Fixed Security Profile

At the time the bi-annual statement is issued, a profile demonstrating the cancellation amounts will also be provided, should the generator want the option to fix the attributable liability. Should this option be taken, the attributable liability will be fixed and apportioned in increments of 25% from the trigger date. If the fixed option is taken prior to the trigger date, the generation project will have a £/kW liability until the trigger point is reached, starting at £1/kW building up to a maximum of £3/kW. This liability will be capped at 25% should the £/kW value be higher than 25% of the liability.

For the avoidance of doubt, only attributable liability can be fixed, wider liability cannot be fixed.

| | |
|--------------------|--------------------------------|
| Completion year | 100% of estimate of total cost |
| Completion year -1 | 75% of estimate of total cost |
| Completion year -2 | 50% of estimate of total cost |
| Completion year -3 | 25% of estimate of total cost |
| Completion year -4 | £3/kW |
| Completion year -5 | £2/kW |
| Completion year -6 | £1/kW |

To fix liability the generator must return a signed copy of the Appendix MM3, as described in Section 9, along with the security amount and prior to the security deadline (typically 45 days prior to the start of the next security period).

Once the Fixed Cancellation Charge has been selected, there is no option to revert back to an Actual Attributable Works cancellation profile.

Should a project be terminated, or reduce the capacity within their agreement, this fixed cancellation charge will not be reconciled; no refund will be given, and no further amounts will be invoiced.

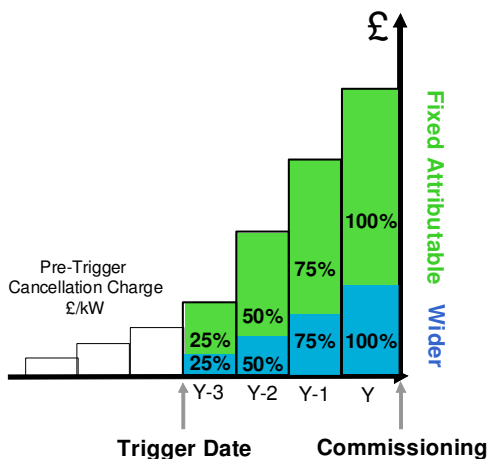

7. Security

A key benefit for generation projects under the new arrangements is that the level of required security does not follow the same profile as the liability.

- Post Commissioning generators are not required to secure their wider liability.
- Pre Commissioning generators do secure a percentage of the liability; however this percentage reduces at trigger points as likelihood of completion increases.

| Stage of generation project | Security as a percentage of annual liability |
|---|--|
| > 4 years from completion (Before trigger point) | 100% |
| Pre consents (between trigger point and consents) | 42% |
| Post consents | 10% |
| Post commissioning | 0% |

These reductions are based on an assessment by the TO of the percentage of new projects which cancel, before or after achieving consents. The percentage reduction at each trigger point will be reviewed periodically. The current assessment is based on data between 2007 and 2011.

For the avoidance of doubt, before the trigger date the security will always be 100% of the liability, regardless of consent.

The red line on the graph below shows the required security over the liability.

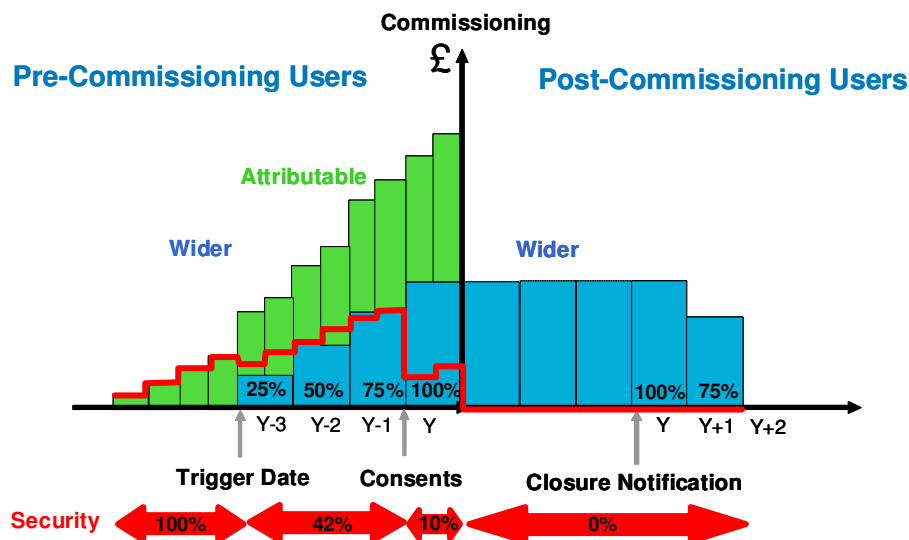

Key Consents

Key consents which trigger the reduction of security to 10% of liability, relate specifically to the generator's key consents. This milestone has been used to reduce security, as a result of analysis on terminated projects. This analysis showed a reduced risk of generation projects not reaching completion, after consents had been achieved. Typically, NGET will be satisfied that consents have been achieved once the developer provides notification that all key consent items have been granted in respect of the appropriate act. Example below:

"The consent and/or planning permission required to construct the Power Station granted (as appropriate and depending on location and size of Power Station) under or pursuant to Section 36 of the Act, the Planning Act 2008, the Town and Country Planning Act 1990 and Town and Country Planning (Scotland) Act 2006 and the discharge of such conditions

attached to that consent and/or planning permission as The Company acting reasonably shall require.”

However, there may be cases where conditions associated with consents must be also be discharged. Customers should contact their Customer Account Manager if they believe that they have been granted the key consents that enable them to commence works on the generation site. Once NGET is satisfied that key consents have been achieved, reductions to security requirements may be changed mid period and any resulting surplus security returned to the customer.

8. Termination, closure and capacity reduction

Pre commissioning - Actual

For a generation project that has remained on the Actual liability, and the agreement is terminated, NGET will invoice for the liability detailed in the MM1 (cancellation charge). The liability will be reconciled against actual spend, and the difference either invoiced or credited to the developer.

Should the developer fail to pay the invoiced cancellation charge, NGET will draw down on the secured amount detailed in MM2 (Cancellation Charge Secured Amount) and seek to recover any remainder through other channels.

Pre-commissioning - Fixed

For a generation project that has chosen to fix their liability, and the agreement is terminated, NGET will invoice for the liability detailed in the MM1 (cancellation charge). If capacity is reduced (partial termination), NGET will invoice for the proportion of the liability that the MW reduction reflects. The cancellation charge will not be reconciled to reflect actual spend.

As with Actual, should the developer fail to pay the invoiced cancellation charge, NGET will draw down on the secured amount detailed in MM2 (Cancellation Charge Secured Amount) and seek to recover any remainder through other channels.

Post-commissioning

The liability for a post-commissioning generator is dependant on the notice provided for closure or capacity reduction.

If notice is given greater than two years prior to closure or reduction, the liability will be 0% of the wider charge and therefore no action will be taken.

If notice is given less than 2 years prior to closure or reduction (1 year and 5 days), the generator will be invoiced for the percentage of the cancellation charge as described in Part 6 of this document. The invoiced amount will be calculated using the wider cancellation charge statement in place at the date of notification.

9. Date Changes

For pre commissioning generation projects where the date of commissioning changes, the treatment of the Trigger date (as described in section 6 of this document) differs dependant on this is initiated by the User or the Transmission Owner.

Date Changes by User

Where a change is initiated by the developer, the principles below will apply:

1. If the change in date occurs pre trigger date, the trigger date will be revised to the default position in respect of the revised commissioning date,
2. If the date change occurs post trigger date, the trigger date will not be revised in respect of the revised commissioning date. The fixed attributable and wider profile will be held at the current level and will increase from that level in line with the revised construction programme.

However, where an application is made by a User to change the completion date, and this application is submitted prior to the CMP192 effective date of 1 April 2013, the trigger date will be revised to the default position in respect of the revised commissioning date for this transitional period.

Date Changes by TO

Where a change is initiated by the Transmission Owner, the principles below will apply:

- If the change in date occurs pre trigger date, the trigger date will be revised to the default position in respect of the revised commissioning date,
- If the date change occurs post the trigger date, the trigger date will also be revised in respect of the revised commissioning date.

10. CUSC

CMP192 is now detailed in the CUSC within Section 15 - User Commitment methodology⁹. This part of the guidance document lists the newly implemented and amended CUSC sections. The key benefits of codifying security arrangements within CUSC, are to provide transparency of the methodology, and to enable any CUSC party to be able to raise a modification to these arrangements, using the usual CUSC governance process.

A full list of the amended and new CUSC sections is provided below; these will give you a fuller understanding of the revised format for Construction agreements and associated appendices:

- [Section 10 – Transition Issues](#)
- [Section 11 – Interpretation and definitions](#)
- [Section 15 – User Commitment methodology](#)
- [Schedule 2 Exhibit 3 – Construction Agreement](#)
- [Exhibit MM1 Cancellation Charge Statement](#)
- [Exhibit MM2 Cancellation Charge Secured Amount](#)
- [Exhibit MM3 Notification of Fixed Attributable Works Cancellation Charge](#)

Although these new sections and appendices have been added to CUSC, they are not effective until 1 April 2013. The new form of the construction agreement and the associated appendices will be introduced in line with the transition plan detailed in part 13 of this document.

Cancellation Charge Statements

Under new CUSC Section 15, NGET will be providing Users with 1 new appendix (Appendix MM) and 3 bi-annual statements (Appendix MM1-MM3) which outline liabilities and/or securities required on a bi-annual basis. The appendices and statements are explained below.

MM Attributable Works

This appendix will form part of the construction agreement and will include the following items:

- The works that have been designated as attributable.
- The LARF (Local Asset Reuse Factor) for each attributable component.
- The SIF (Strategic Investment Factor) for each attributable component.
- Key Consents.

MM1 Cancellation Charge Statement

This bi-annual statement details the cancellation charge (**liability**) for the forthcoming six month period. (This is **NOT** the amount required to be secured). This will include the following items:

- Wider Cancellation Charge.
- Attributable Cancellation Charge.
- Total Cancellation Charge (Sum of the wider and attributable).
- Generation zone in which the Power Station will be connecting into.
- This will be a statement signed by an authorised NGET signatory.

MM2 Cancellation Secured Statement

This bi-annual statement details the amount of the cancellation charge that must be secured in the forthcoming six month period. This will include the following items:

- Security Amount for the forthcoming six month period.
- Total cancellation charge (Sum of the wider and attributable).
- Percentage of the total cancellation charge used to calculate the secured amount (10%, 42% or 100%).
- This will be a statement signed by an authorised NGET signatory.

MM3 Notification of Fixed Attributable Works

This statement provides the user with their **attributable liability** from the date of the statement to completion, if the fixed option is elected.

This will include the following items:

- Pre trigger date will detail the £1/£2/£3 per kW per financial year*.
- Post trigger date will detail the percentage of the estimate of the final attributable works capital cost that makes up the fixed cancellation charge.
- The attributable works, costs and factors that the fixed cancellation charge is based upon
- For the avoidance of doubt, the user can only fix their attributable works cost, the wider cancellation charge will always be based on the wider tariff information published on the NGET website.

*Notes on the £/KW amount

- £1/KW only applies to the first year after signature of connection agreement and; £2/KW only applies in the second year after signature of connection agreement. £3/KW applies in the third year after signature until trigger date is reached.
- When opting to fix pre trigger date, the fixed cancellation amount will be in respect of the date the construction agreement was signed, ie if fixing in the third year after signature or more, and pre trigger date, the user would go straight to £3/KW.
- Where £1/KW, £2/KW or £3/KW is greater than 25% of the total attributable cancellation charge, the cancellation charge for the pre trigger years will be capped at 25% of the total attributable cancellation charge

11. Offshore arrangements

The new user commitment arrangements apply to offshore generation in the same way that it does for onshore generation. Onshore and Offshore transmission owners will provide Capex costs for attributable and wider investments, which will be used to calculate liabilities.

Generator Build

Where the offshore assets are built by the User under the Generator Build option, these assets are out of scope for new arrangements. NGET will not require security from a Generator Build party for transmission assets being built under OTSDUW Arrangements. For clarity, only transmission assets being constructed by a Transmission Owner will be captured by the arrangements in CUSC Section 15.

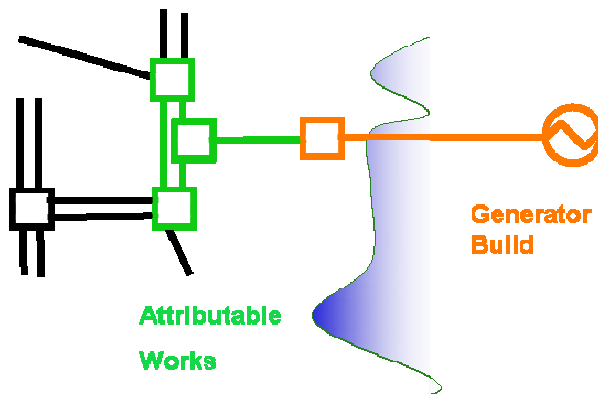

Integrated Offshore

The arrangements for an Integrated Offshore solution are currently being consulted on by Ofgem, and will be developed further by the industry. As noted above, in its current form the new arrangements will only apply to transmission being developed by TOs; however this does not preclude proposals being made to amend section 15 as integrated offshore is developed further.

In the example below both the links to the onshore transmission and the integrated links between platforms are being constructed by an OFTO, and therefore the new arrangements would apply. The attributable works will be the minimum works required to connect the offshore generator to the MITS (shown in green). Any links between offshore platforms (shown in blue) will not be categorised as attributable, and therefore by default be categorised as Wider. In this example, the generation project will only be exposed to specific liabilities for the minimum works to connect to the MITS and the integrated links will be socialised into the wider cancellation charge.

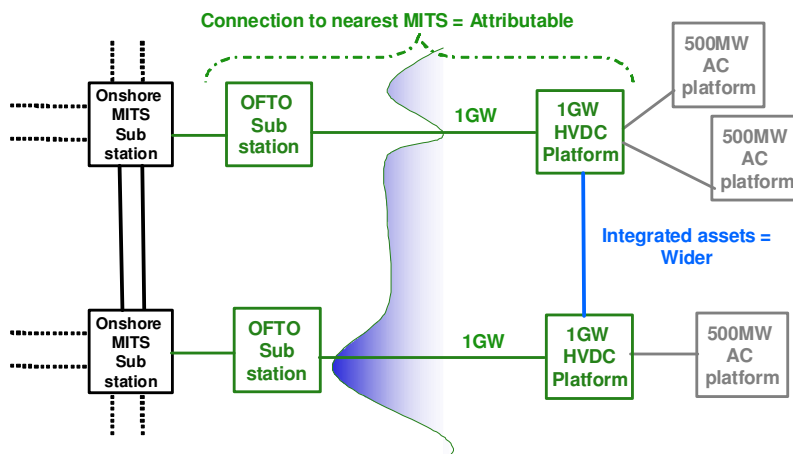

As more co-ordinated/integrated offshore designs are developed by the industry, the user commitment arrangements specific to these will be need to be explored. These discussions are expected to be progressed as part of the consultations on co-ordinated networks, being proposed by Ofgem.

12. Embedded Generation

Generation projects connected to the distribution networks (referred to as embedded generation) may also have an impact on the transmission system, and therefore may also have a liability for works on the transmission system. This part of the guidance document explains how the new arrangements apply to embedded generation.

In the new arrangements, embedded generation will not carry a user commitment liability post commissioning, either directly through connection agreements with NGET, or through connection agreements with the Distribution Network Operator (DNO).

The pre commissioning user commitment arrangements will apply to embedded generation projects with an impact on the transmission system. Embedded generation projects with Bilateral Embedded Generation Agreements (BEGAs) have access to the transmission system. In these cases, NGET will pass the pre commissioning wider liability to the User, and the attributable liability to the DNO.

For embedded generation projects without transmission access, ie Bilateral Embedded Licence Exemptible Large Power Station Agreement (BELLAs) and Statement of Works projects (SOW), NGET will pass both the pre commissioning wider liability and the attributable liability to the DNO.

In these cases, the DNO may choose to pass a liability onto the embedded User through their distribution connection agreement. The contractual relationship between the DNO and the embedded generation projects falls outside of the CUSC, and therefore the user commitment arrangements under Section 15 do not apply via the DNO. NGET are actively involved in moving forward discussions in this area, as it has been raised as an issue through DCUSA and the DG forum.

13. Non Generation User commitment.

The user commitment methodology detailed in section 15 of CUSC is only applicable to generation. As such, demand connections and Interconnectors will remain on the current interim arrangements until 31 March 2015. This decision was made by Ofgem following consultation in December 2012.

<http://www.ofgem.gov.uk/Pages/MoreInformation.aspx?docid=7&refer=Networks/Trans/ElecTransPolicy>

14. Transition of existing pre commissioning generation

CMP192 was implemented on 1 April 2012, with an effective date of 1 April 2013. The year between implementation and effective date, was to enable well developed working level processes to be implemented, and to allow an efficient transition of existing agreements. The timeline below details the dates for transition, and the dates by which NGET will provide Users information in respect of the new arrangements.

Whilst this timeline is our current expectation and the plan we are working to, some of the new processes have not yet been fully developed from the principles that were implemented by the modification, and as such the dates by which we endeavour to provide this information may be subject to change during the transitional period.

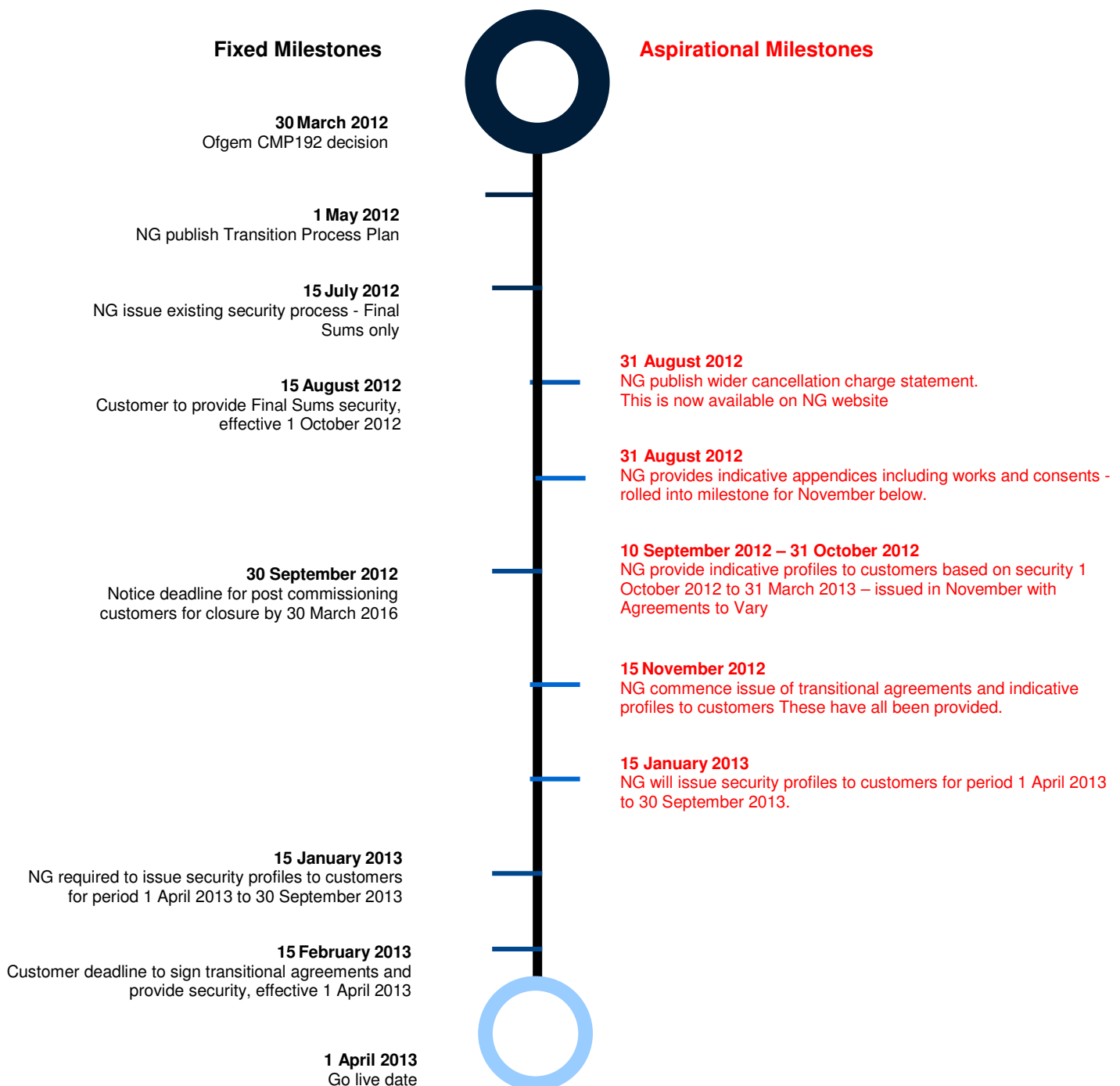

15. New applicants

During the transition period, new applicants will be offered connection agreements in the normal CUSC timescales. Until the full processes are developed and the liabilities for the period beginning 1 April 2013 are calculated, offers will continue to be made under the existing user commitment arrangements.

It is our expectation that the offers made from November 2012 will receive an offer in the current arrangements and an agreement in the form of the new arrangements, with security effective 1 April 2013.

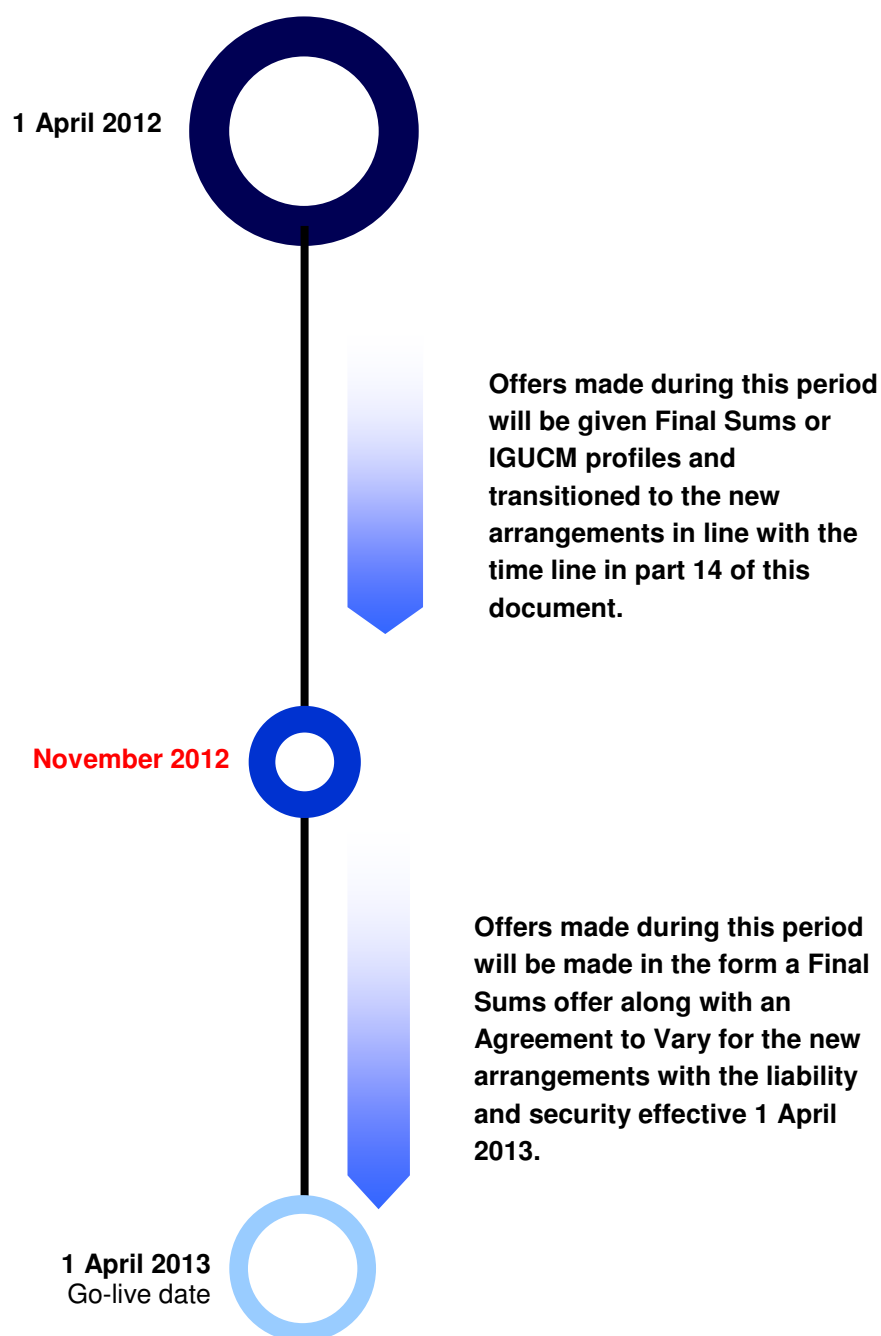

16 . Frequently asked questions

To add further clarity to the arrangements detailed in this guidance document a collection of questions and answers are detailed below. This section has been updated with questions raised during transition.

Where can I find more detail about CMP192?

Full CMP192 background and information can be found on our website:

http://www.nationalgrid.com/uk/Electricity/Codes/systemcode/amendments/amendment_archi ve/

Will customers get offers in the form of the new arrangements from this point onwards?

No, the effective date of the new arrangements is 1st April 2013. We expect that offers made from November 2012 to have both a Final Sums and CMP192 offer and offers from January 2013 to be in the form of the new arrangements.

When will customers see first sight of the project specific security information?

The Wider Liability data covering the period from 1st April 2013 to 31st March 2014 for post commissioning generators was made available on the 1st September 2012 and ongoing it will be published annually.

For the security period commencing 1st April 2013, we will be issuing project specific information on 15th January 2013.

Do customers need to sign outstanding offers, or will you reissue a new offer?

Signed agreements will be transitioned to the new arrangements ahead of 1st April 2013; any outstanding offers should be signed and will transition in line with the plan. (Plan was published on 30th April 2012)

Is there an option to stay on IGUCM/Final sums?

There are no options for generation projects to stay on IGUCM/Final Sums (grandfathering). Although grandfathering the existing arrangements was an alternative discussed in the working group, this option was not implemented by Ofgem.

We expect offers made from January 2013 will include new profiles with security effective from 1st April 2013. Customers with existing Construction Agreements will be transitioned to Section 15 with effect from the 1st April 2013.

The only exception to this is non generation agreements, as described in section 13 of this document.

If a generator is currently on IGUCM (ie fixed) are they limited to the fixed option of the new arrangements?

All generators will be given the opportunity to choose a fixed or variable option when they are given their transitional offer.

What is the trigger date?

Trigger date is 1 April in the financial year which is three financial years prior the to the financial year of connection (as described in section 6 of this document).

Is the Attributable definition the same as the Enabling definition?

No, Attributable and Enabling are two different definitions. Attributable is the Works up to the nearest suitable MITS substation, as defined in Section 15 of the CUSC and is only required for security/liability purposes.

Enabling works are the works required prior to connection and may include works beyond the nearest suitable MITS substation, as required for system operation.

Will there be any opportunity for free TEC reduction before the implementation of CMP192 or in the future?

NGET offered Users the opportunity to request a free review of the impact of reducing TEC or Registered Capacity. This was issued 26 February 2013, link attached: <http://www.nationalgrid.com/uk/Electricity/GettingConnected/PoliciesAndGuidance/>

Under CMP192, will post-commissioned BELLA / BEGA sites not currently subject to TNUoS charges become exposed to the wider cancellation charge.

For a BEGA, the post commissioning wider cancellation charge would be passed to the user as they have explicit TEC. For a BELLA, the post commissioning wider cancellation charge would be passed to the DNO.

What is the definition of security; is it essentially a part-deposit for works to be undertaken?

Security is a proportioned amount of the liability for the transmission works undertaken on your behalf

How do the new arrangements work for Interconnectors which are currently on IGUCM or Final Sums?

The new arrangements do not apply to Interconnectors. Interconnectors that are currently on IGUCM or Final Sums will stay on their current security methodology, as outlined in section 13 of this document.

How will this effect Embedded generation?

When the User has a contract for works with NGET ie BEGA, the liability for wider works are passed to the User, and the attributable works to the DNO. When there is no Construction Agreement with NGET, all of the liability is passed to the DNO.

How will this effect Demand Connections?

New and existing Demand Connections eg Network Rail projects, will be offered Final Sums security only.

Does any security need to be updated ie Letter of Credits, Parent Company Guarantees or Escrow accounts?

Security amounts will change under the new arrangements, so any existing security valid after 1st April 2013 will need to be updated. Parent Company Guarantees (PCG) may refer to clauses in the Construction Agreement which under the new arrangements may have changed. These PCG references will need to be updated, and a suggested template incorporating these changes is available from your Customer Account Manager

Who picks up the shortfall between security and liability should the user not pay when invoiced?

NGET will pursue all credit management options to recover any outstanding liabilities from the customer. Any remaining shortfall would be recoverable from all users through an annual adjustment to the Maximum Allowed Revenue (MAR), as set out in the Licence.

Does the 2 year post commissioning liability start before commissioning?

The post commissioning liability will only begin at the commissioning date of the project, ie, when the generator starts to pay TNUoS.

Sample profiles under CMP192

Customers may have received sample Section 15 profiles during the development of the CMP192 proposal. These examples were loosely based on the principles of the new arrangements, however they were not split into the Attributable & Wider categories and were intended as indicative numbers to give an understanding of the CUSC modification. The data used for these examples was from January 2011. Since then, a more up-to-date indication of these profiles has been provided using the July 2012 final sums and IGUCM data, which also include correctly categorised works. These profiles were provided in November 2012, and actual profiles will be issued in January 2013.

Is the nearest suitable MITS geographically closest or nearest site electrically (MW).

The nearest suitable MITS is the geographically closest 'as the crow flies.'

How is the nearest suitable MITS decided?

The nearest suitability of a MITS is determined by the TO when making an offer, and can include considerations such as the most economically or geographically suitable MITS.

Is the construction of a new MITS substation “Attributable” or “Enabling”?

Construction of a new MITS would be attributable, as all of the works up to and at the nearest suitable MITS would be attributable. Enabling is the Connect & Manage definition of the works required to be completed before the generator can connect. This is likely to be attributable works as defined by CMP192.

If a MITS is being demolished and a new MITS put in it's place, is that work attributable or wider?

The CUSC definition of attributable works (below) states that it should be the components that are required to get from the connection site to the nearest suitable MITS, and should include any new MITS that would be created.

How will the specific reuse factors be calculated?

For wider works the asset re-use factor will be 33%. This figure is fixed, but will be reviewed periodically and the TO will provide specific re-use factors for each component of the attributable works. Should specific re-use data not be available, then the wider re-use factor will be applied as a default, currently 33%.

After shared transmission reinforcement works have been completed are they still considered ‘at risk’ and therefore requiring security, or do these fall out of the works that needs securing?

In theory, providing a user has not fixed their attributable works, an attributable scheme could be removed once the risk of stranding of the scheme is removed. However, it is likely that all of the generation triggering the scheme will need to connect before the TO is satisfied that there is no further risk of stranding.

Are the SIF and LARF and Distance Factor updated throughout the construction programme? Are they re-determined in the event of termination, and can Actual Attributable Works liability be capped?

LARF is an estimation of the amount of reuse and this will reflect the full construction period. Upon termination, the amount of reuse will be reconciled. If the user opts to fix the attributable profile, there would be no reconciliation upon termination of cost or reuse. Fixing can be done at any time, pre or post trigger.

Do fixed profiles start at £1/KW?

If the fixed option is chosen, the pre trigger date attributable liability will build up from £1/kW until it reaches a maximum of £3/kW. The starting point will be based on the date that the original agreement was signed, eg, if the generation project opted for a fixed liability 3 years after the contract was signed (and more than 4 years from connection date), the fixed liability would be £3/kW. For the Avoidance of Doubt, the £1/kw rate only applies in the first year of signing an offer.

What are the inputs into Wider Tariff?

This is calculated by taking TO Load related and Non-load related Capex, and removing attributable Capex to give the wider Capex. This is apportioned by SYS (now ETYS) zone boundary capabilities and zonal impacts. Please note that the Seven Year Statement (SYS) has been replaced by the Ten Year Statements (ETYS). The zones for both will remain the same for the foreseeable future.¹⁰

Why both load and non load related?

The Capex shared between existing and future generation and between generation and demand, therefore input should be new and system maintenance work.

Where does the Capex forecast come from?

TO are required annually to provide a wider Capex forecast for the next 4 financial years.

¹⁰ <http://www.nationalgrid.com/uk/Electricity/ten-year-statement/current-elec-tys/>

When is the next update/enduring process?

Actual profiles will be issued on or before 31 January 13, and annually thereafter.

Are the wider works portion of the overall liability fixed and due in full, from 4 years out from the connection date?

The wider cancellation charge will be published annually and from trigger date, the wider liability increases in 25% increments, starting at 25% of that year's annual charge, increasing to 100% of the charge in the year of completion.

If a user sharing attributable works terminates, what is the impact on the remaining user(s)?

Each users liability is limited by the SIF and therefore capped at TEC capability.

Will users still be liable for, and have to secure, connection asset charges post connection?

For pre commissioning generation where connection assets have been identified as attributable works, then they will be secured under the new arrangements.

For post commissioning generation, connection assets can either be paid for upfront in which case no security would be required, or these can be paid for over an agreed period (normally 25 or 40yrs). In this case, a termination amount would be secured by the user. This termination amount is not secured under the new arrangements, and this process is detailed in CUSC 2.20 and 2.21

When do I need to sign the agreement to vary?

The transitional agreement must be signed by 15th February 2013, in line with the deadline for security provision.

How flexible is this date?

This date is inline with the security process in each contraction agreement. If this date is not achievable you should contact your CAM as soon as possible.

If we do not sign the by 31st March 2013 will our existing agreement be terminated and on what contractual basis?

We will of course discuss agreements with users prior to 31st March 2013, however as the previous arrangements are no longer available after this date, transition to the new arrangements must be in place. As with existing security arrangements, failure provide security by the 15th February 2013 would be an event of default, which could ultimately lead to termination.

What constitutes users key consents?

Key consents will be specific to each project, so it is not always possible to determine what consents are required and what conditions may be associated with granting of these consents. As such, we have included a generic paragraph in the Appendix MM, and CAMs will work with Users to determine when all consents are granted and discharged on an individual basis. NGET will need to be satisfied that the project is intending to proceed.

What if a generator only receives partial key consents? (ie for only a proportion of their agreement).

If a generator receives partial contents, their security will remain at 42% of their liability. In order to reduce security to 10%, the customer may consider reducing the capacity of their agreement (to reflect the consent) or splitting it into two separate agreements, via the modification application process.

When does security need to be provided?

Construction agreements and CUSC Section 15 require a User to provide security 45 days before the start of the security period. There are 2 6 month security periods each year; starting on 1st April and 1st October.

What forms can the security take?

Acceptable forms of credit are Letters of Credit, Performance Bond/Parent Company Guarantee or use of an Escrow Account.

What changes have been made to the agreement appendices?

Where applicable to your current construction agreement the following revisions have been made:

- Appendix H: The categorisation of works associated with the previous security regime has removed and replaced with a simplified categorisation of enabling works, wider derogated works and wider non derogated works
- Appendix J: Removal of references to previous security methodologies
- Appendix M: Removed from Construction agreement. Details now in CUSC section 15.
- Appendix MM: Addition of new appendix that identifies the Attributable Works.

What are the new statements I will be receiving for security?

The MM1, MM2 and MM3 are explained on Page 14 of this document.

What is the difference between the figures on the MM1 and the MM3?

The difference between the MM1 and MM3 is actual v fixed.

Can you provide S curves for the full period for both attributable and wider costs?

- We recognise the value of S curves to customers, and will endeavour to provide S curve information for actual attributable works where the information is available.
- S curve for the fixed attributable works can be derived from the MM3 bi-annually.
- S curve for the wider cancellation charge can be derived from the wider cancellation statement published annually on our website.

What is the treatment of Connection Assets, and how are they defined - in particular in relation to attributable works?

For pre commissioned Users where connection assets have been identified as attributable works, these will be secured under the new arrangements.

For post commissioned Users, connection assets can either be paid for upfront in which case no security would be required. Alternatively, these connection assets can be paid for over an agreed period (normally 25 or 40yrs). In this case, a termination amount would be secured by the user. This termination amount is not secured under the new arrangements, and this process is detailed in CUSC 2.20 and 2.21.

What is the definition of security – is it essentially a part-deposit for works to be undertaken?

Security is not a part-deposit. Security would only be drawn upon in the event of failure to pay a cancellation charge invoice, and is returned upon completion or payment of that invoice.

The amount of Security required is a proportion of a user's liability for the works to be undertaken on their behalf, to allow connection to the system.

The liability, also known as the cancellation charge, is shown in Part 1 of the MM1 and again on the MM2. More than 4 years prior to the charging date of the project, the security will be 100% of the liability. Once past the trigger date, that is to say less than 4 years from the charging date, this is reduced to 42% of the liability or 10% if your key consents are achieved.

Regardless of the level of security in place, the liability of the project upon termination (subject to reconciliation as and where appropriate) will remain as per MM1.

The diagrams in Sections 6 and 7 could use more explanation. Do they represent a six-monthly payment profile?

The diagrams in Section 6 and 7 provide demonstrations of liability over the lifecycle of the project. The actual attributable amounts can change biannually, whereas the fixed attributable and wider amounts are annual values.

It would be helpful to represent on the diagrams the in-service period between pre-commissioning and post-commissioning - are the charges zero? How does this then relate to the commencement of TNUoS charges, and is there a relationship between TNUoS and works carried out?

Each Construction agreement includes a defined charging date. Prior to the charging date, the pre commissioning user commitment applies, and after the charging date the post commissioning user commitment will apply, in addition to TNUoS where applicable.

What is the post-commissioning treatment of attributable assets?

No security or User commitment is required for attributable assets post commissioning. The exception to this is for connection assets, as noted in Question 1.

How and how often will updates be provided on ongoing developments in liabilities over the four-year pre-commissioning period?

Bi-annual statements of liability and security requirements will be issued in January and July, however;

- The Wider cancellation will only increase annually (from 1 April)
- The fixed attributable amount will only increase annually (from 1 April)

The current wider cancellation amount and a forecast of the next 3 years will be published annually, on or before 31 January.

What are the implications of the various dates (triggers, connection, etc.) being changed (forward or backwards) a) by the Customer and b) by the TO?

The default trigger date is the 1 April in the financial year which is 3 financial years prior to the financial year of the completion date, eg where the completion date is 31/10/17 the trigger date would be 01/4/14

| Year | | |
|------|----------|----------|
| y-3 | 01/04/14 | 31/03/15 |
| y-2 | 01/04/15 | 31/03/16 |
| y-1 | 01/04/16 | 31/03/17 |
| y | 01/04/17 | 31/10/17 |

a. Completion date changing on customer request.

- Where the User requests a change to the completion date pre trigger date, the trigger date will be moved in line with the revised completion date. (ie 1 April in the financial year, 3 financial years prior to the financial year of the revised completion date).
- Where the User requests a change to the completion date post trigger date, the trigger date will not be moved in line with the revised completion date. (ie trigger date would be 1 April in the financial year, 3 financial years prior to the financial year of the completion date prior to the change).

b. Completion date changes by the TO.

- If the TO changes the completion date pre or post trigger date, the Trigger would be revised to the default position in respect of the revised completion date.

If connection dates change or planning consent is gained within a security period, is it always necessary to wait for the next security review before the amount changes?

A revised security profile would normally be issued with an agreement that changes the completion date, and security would be required upon acceptance of that agreement.

Where the user notifies NG that consent is achieved mid security period, there is no reason for us to hold the higher level of security until the next biannual statements are issued.

What are the processes and procedures for capacity reduction? And is there anything to say about increasing capacity?

Pre-commissioning capacity reduction is detailed in CUSC section 15 part 2 - 3.9 & 3.10

- Where the reduction is effective before trigger date;
 - Attributable works Actual – Cancellation amount is an actual works cancellation amount.
 - Attributable works Fixed – Reduction in TEC*pre trigger amount (either £1,2 or 3/kw) (or 25% of cancellation charge if lower)
 - Wider – N/A
- After Trigger date
 - Attributable works Actual – Cancellation amount is an actual works cancellation amount.
 - Attributable works Fixed – Attrib works cancellation amount*MW reduction*cancellation charge profile (%)
 - Wider – Zonal unit amount*MW reduction*cancellation charge profile (%)

Capacity increase would require a mod application and is likely to result in a second construction agreement for the additional capacity and a separate security profile for that agreement.

When are potential users repaid in the event that a project does not proceed?

Upon termination, users will be invoiced for the cancellation amount;

- The wider element of this cancellation amount isn't subject to any further reconciliation.
- If fixed, the attributable amount isn't subject to any further reconciliation.
- If Actual, Within 60 days the generator will be provided with an estimate of the revised estimate of the attributable cancellation charge, and justification of spend and any reuse. As soon as possible after this (and a maximum of 12 months of the termination or reduction) the generator will receive a revised statement, and any difference will then be credited or invoiced to the generator within 28 days of the statement being issued.

What is the information flow on the data behind the budgeted expenditure on upgrades, the LARF and the SIF? There should be some formal way in which this has to be presented to CUSC parties.

NGET and the other TOs provide a cancellation amount, an estimation of potential reuse and the capability for each component. We would encourage any customers to discuss specific project progress and variables with CAM.

Up until now, connection dates have not impacted on security. Now they do, how will connection timescales (that may not always be realistic) be corrected and / or accounted for?

CMP192 was in part designed to keep completion dates realistic, and those projects that are more uncertain, outside of the 4 year trigger period. We expect CMP192 to drive a number of completion date changes from both TOs and Users.

During the transitional period, we have received a number of applications to change dates as well as issuing a number of revised dates due to TO notifications.

How does CMP192 impact on user commitment in Scotland? What can we expect in Scotland moving forwards?

The information required for the new arrangements under CMP192 is now a requirement under the System Operator - Transmission Owner Code (STC). Projects in Scotland have same user commitment arrangements as in England and Wales.

How will changes, including reductions in user commitment resulting from CMP192 be passed through to embedded generators, how will DNOs treat securitisation, and what developments have there been further to Section 11?

The user commitment required by NGET for embedded generation with a transmission impact, comes from its contractual relationship with the relevant DNO. We are aware that DNOs are currently discussing whether they should pass on the full or reduced liability. NGET has raised this with issue with DNOs, Ofgem and with the DCUSA issues group

16. Version Control

| | | |
|-------------|--|----------|
| | | |
| Version 1 | Published Version | 14/05/12 |
| Version 0.1 | <p>Changes:</p> <p>Further Clarification Definitions of SIF/DF/LARF.</p> <p>Definitions and descriptions of MITS.</p> <p>Section added for STC.</p> <p>Key Consents Paragraph revised.</p> <p>Wider Tariff information and examples added.</p> <p>Descriptions of new Appendix MM and Bi-annual statements included.</p> <p>Additional information regarding Appendices H & J provided.</p> <p>Date & TEC Change sections added.</p> <p>Closure examples provided.</p> <p>Frequently asked questions revised</p> | 29/01/13 |
| | | |
| | | |