

National Grid UK Electricity Transmission plc

NATIONAL SAFETY INSTRUCTION 6 and Guidance



DEMARCATIION IN SUBSTATIONS



Copyright National Grid ET plc 2026 ©, all rights reserved. No part of this publication may be reproduced, stored in a retrieval system, or transmitted in any form or by any means electronic, mechanical, photocopying, recording or otherwise, without the written permission of National Grid obtained from the issuing location.

The contents of National Grid documents are based on the needs of National Grid and the conditions under which it operates. It shall not therefore be assumed that the contents stated therein necessarily meet the particular circumstances and requirements of other organisations. The principles set out in this document are for information only and therefore National Grid is not liable to any third party for any loss or damage resulting from reliance on the contents. It is the responsibility of such external organisations to check that the document is the latest version and is appropriate for their purposes.

DOCUMENT HISTORY

Issue	Date	Summary of Changes / Reason	Author(s)	Approved By (Title)
1	Nov 2009	Formatted and re-drafted to follow 3 rd edition Electricity Safety Rules layout. Safety notes and safety bulletins	NSI Working Group	MDE Manager Les Adams 
2	April 2011	Annual review; document amended as detailed below and minor text changes as highlighted in yellow.	NSI Review Group	MDE Manager Les Adams 
3	April 2014	Renamed as "National Safety Instruction and Guidance" which now incorporates and replaces NSI 6 Issue 5.	NSI Review Group	ETAM Operations North Manager Mike Dean
4	April 2016	Annual review; document amended as detailed below and minor text changes as highlighted in yellow.	NSI Review Group	ETAM Operations North Manager Matt Staley
5	March 2021	Reviewed and Reformatted	Electricity Transmission Operations Safety Rules Team	Head of ET Operations Matt Staley
6	Feb 2022	Full review & update	NSI 6 Working Group	Matt Staley Director of Asset Operations
7	Jan 2023	Minor update	Safety Rules Team	Matt Staley Director of Asset Operations
8	May 2024	Minor updates	Safety Rules Team	Ro Quinn Director of Asset Operations
9	April 2026	Minor updates	Safety Rules Team	Kate Grant Director of Asset Operations

KEY CHANGES

Section	Amendments
Various	Addition of the the word rope (as alternative to chain or barriers) – rope is similally coloured to the chain or barriers and supplied by the National Contracted supplier.
5.1d Rule	Words 'where reasonably practicable' added to the Green cones shall be placed 1m inside the work area, this is to allow for scenarios where space is at a premium.
9.2a Rule	Clarity added to confirm erection of demarcation after all safety precautions have been established.

DEMARICATION IN SUBSTATIONS

CONTENTS

	Page
1 Purpose and Scope	1
2 Definitions	2
3 Dangers	3
4 Risk Assessment	4
5 General Demarcation of Work Areas	5
6 Additional / Alternative Demarcation of Work Areas on Gas Insulated Switchgear (GIS)	7
7 Additional / Alternative Demarcation of Work Areas on or near Metal Enclosed (HV), Low Voltage and Mechanical Equipment	9
8 Demarcation of Risk Management and General Hazard Zone(s)	11
9 Roles and Responsibilities – Demarcated Work Areas	12
10 Roles and Responsibilities – Risk Management and General Hazard Zone(s)	13
11 Contractor’s Work Area Demarcation	14
Appendix	
A – Examples of NSI 6 Demarcation Drawing	15
B – Examples of Demarcation for Work Areas	17
B1 - Permit for Work	
B2 - Testing	
B3 - Limited Access Certificate	
B4 - Where a Natural Fence Already Exists	
B5 - Gas Insulated Switchgear	
B6 - Low Voltage	
B7 - Mechanical	
C – Examples of Demarcation for General and Risk Management Hazard Zone	32
C1 - General Hazard Zone	
C2 - Risk Management Hazard Zone	
D – Examples of Contractor’s Work Areas	35
D1 - Off Safety Rules	
D2 - Where Contractors Work Area and Safety Rules Demarcation Area are the same size	
D3 - Where a Safety Rules Demarcation Area is inside a Contractor’s Work Area	
E – Safety Notices	37
F – Authorisation Matrix for Contractors Personnel	38

1 Purpose and Scope

To apply the principles established by the Safety Rules and provide guidance on National Safety Instruction 6, on the use and application of demarcation for work to achieve **Safety from the System** for **Personnel** working on or near to **Equipment** in substations. This also includes *Risk Management Hazard Zone(s)* and general hazard zones to ensure safety.

In line with the Construction Design and Management (CDM) regulations – all work classified as Cat 1 or 3 within AMBP 310 is now considered to be work undertaken under CDM Regulations and needs to demonstrate controlled access / egress to the work area. The delineation of the work area by the use of the demarcation described in this document will now be considered as the initial default position to demonstrate CDM compliance.

There are two levels of authorisation to this NSI for a **Senior Authorised Person**, limited and full.

Limited authorisation roles and responsibilities are for:

- OHL **Senior Authorised Person** for demarcation application in a Substation.

Full authorisation roles and responsibilities are for:

- Substation **Senior Authorised Person** for demarcation of **HV, LV** and mechanical **Equipment**.

The layout of this guidance note reflects that of legislative codes of practice, where the rule (or mandatory obligation) is identified by a green panel on the left-hand side. The guidance follows after the rule and is identified by a blue panel.

Within National Grid, guidance notes hold equivalent status of an Approved Code of Practice (ACOP) in law. If not followed, you will be required to demonstrate that your safe system of work is of an equal or higher standard.

2 Definitions

Terms printed in bold type are as defined in the Safety Rules.

Title	Definition
<i>Access Point Notice</i>	A notice defining access to and egress from a demarcated area (Pedestrian access for crossing chains, rope or barriers at other points is strictly prohibited)
<i>Access Prohibition Notice</i>	A notice prohibiting access
<i>Danger Notice</i>	A notice which is attached to Equipment and structures to warn of electrical or mechanical Danger(s)
<i>Designated Gas Zone Access Point Notice</i>	A notice identifying all required access points to the gas zone which require venting prior to access in accordance with Management Procedure - NSI 10 "Equipment Containing Pressurised Insulating / Interrupting Gas"
<i>Keep Clear Overhead Live Equipment Notice</i>	A notice warning about Danger from overhead Live Equipment
<i>Risk Management Hazard Zone</i>	An identified area where access is restricted from Equipment , which may have a defect and may have the potential to cause harm
<i>Risk Management Hazard Zone Notice</i>	A notice that is attached to a yellow and black chain, rope or barrier demarcating a <i>Risk Management Hazard Zone</i>
<i>Testing Area No Entry Notice</i>	A notice prohibiting entry to the testing area unless under the Personal Supervision of the holder of the Safety Document
<i>Testing Notice</i>	A notice reading "Test Area" in the form of red sleeves
<i>Vehicle Access Point Notice</i>	A notice defining vehicle access to and egress from a demarcated area (Pedestrian access / egress is only allowed when escorting a vehicle)
<i>Vented Gas Zone Access Point Notice</i>	A notice identifying all required access points to the gas zone which have been vented and can now be entered in accordance with Management Procedure - NSI 10 "Equipment Containing Pressurised Insulating Gas"

3 Dangers

The **System Danger(s)** to **Personnel** arising out of inadequate demarcation in substations are electrocution, burns, impact from release of pressure and effects on eyes arising from:-

- Mistaking **Equipment** on which it is unsafe to work, from that which it is safe to work
- Inadvertently infringing **Safety Distance** to **HV Equipment**
- Inadvertent contact with **LV Equipment**.
- Inadvertent contact when mechanical **Equipment** operates.
- Inadequate planning leading to a failure in the co-ordination of all work activities
- Failure to adequately control risks associated with Hazard Areas and Testing activities

NSI 6
4.1

4 Risk Assessment

- 4.1 The **Senior Authorised Person** shall carry out a site specific written risk assessment taking into account the work to be undertaken to determine the most appropriate system and positioning for defining clear boundaries between safe and unsafe workplaces.

Guidance
NSI 6
4.1

4 Risk Assessment

- 4.1 Demarcation of a work area is a main control measure achieving **Safety from the System** by ensuring clear boundaries between safe and unsafe workplaces. Consideration as to the type of demarcation used and the prioritisation, and positioning of that demarcation for types of **Equipment** is further explained in Sections 5 - 8.

In General, the **Senior Authorised Person** shall consider (but not be limited to) the following as part of their risk assessment:-

- Proximity to adjacent **Equipment**
- **Danger** which may arise from **Live Equipment** or **Equipment** which may become **Live** e.g. over sailing conductors
- The location and need for more than one designated access point including designated vehicle access point(s)
- The work area has adequate space for the proposed method of work, plant and / or equipment to be used
- Controlling the work into the safest position e.g. suitable laydown areas
- Clear delineation of the work / test area
- Nature of works e.g. maintenance, testing, refurbishment or construction etc.
- The unique considerations of the work (environment / restrictions or geographical / operational boundaries)
- Other work going on in the vicinity, if so consider the interface
- Other legislative requirements (All Cat 1 or 3 work will be now considered as under CDM regulations by default)
- Considerations (knowledge & experience) expressed by the **Competent Person** and members of the **Working Party**
- Where it has been identified that more than one **Working Party** is required in a single demarcated work area, consideration shall be given to using multiple smaller demarcated work areas or staggered working arrangements. If this is not reasonably practicable then suitable co-ordination shall be established prior to starting work and maintained throughout the work.

NSI 6
5.1 to 5.3

5 General Demarcation of Work Areas

5.1 Free standing demarcation shall be:-

- (a) Independently supported.
- (b) Not attached to any structure supporting **Equipment**.
- (c) Identified using the appropriate coloured cones placed at intervals not exceeding 6 metres, supporting plastic chain, **rope** or barriers suspended more than 500 mm above ground level or by a rigid barrier.
- (d) Identified by green cones, with coloured sleeves if appropriate, placed 1 metre inside the work area, **where reasonably practicable**, at intervals not exceeding 6 metres.
- (e) Supplemented by a designated access point(s) consisting of two 1 metre high red cones with clear plastic sleeves displaying white lettering indicating "access / egress" directions. These cones should be a maximum width of 1 metre apart. An *Access Point Notice* shall be positioned adjacent to these cones. If no **Safety Document** recipient is on site, the "access / egress" point shall be closed prohibiting access.

5.2 Free standing demarcation is not required where a natural boundary, wall or fence exists. Green cones shall be placed at the entrance point and 5.1(e) shall be met.

5.3 Additional requirements to Section 5.1 and 5.2 for **Safety Document(s)** Demarcation

(a) **Permit for Work / Sanction for Work** area shall be identified by:-

- Red cones
- Red & white chain, **rope** or red & white rigid barrier
- *Danger Notice(s)* attached to adjacent **Equipment** as specified by the **Senior Authorised Person**
- *Access Prohibition Notice(s)* attached to structures / **Equipment** where required as specified by the **Senior Authorised Person**
- *Keep Clear Overhead Live Equipment Notice(s)* placed under **Live** or **Charged Equipment** where required

When testing is required the demarcation shall be supplemented by:-

- *Testing Notice* sleeves placed over green cones at the access / egress point
- *Test Area No Entry Notice(s)* positioned inside the "access / egress" point(s). The "access / egress" point(s) shall be closed

(b) **Limited Access Certificate** work area shall be identified where required by:-

- Blue cones
- Blue & white chain, **rope** or blue & white rigid barrier
- *Danger Notice(s)* attached to all adjacent **Equipment** outside the demarcated work area where required
- *Access Prohibition Notice(s)* attached to structures / **Equipment** where required as specified by the **Senior Authorised Person**
- *Keep Clear Overhead Live Equipment Notice(s)* placed under **Live** or **Charged Equipment** where required

Guidance
NSI 6
5.2 to 5.3

5 General Demarcation of Work Areas

All demarcation shall be carried out in accordance with the standards shown in Appendix B.

5.2 Appendix B “B4 - Where a Natural Fence Already Exists” illustrates the demarcation requirements when a fixed compound with an access gate or an existing fence line forms all or part of the demarcated work area. This situation also includes buildings such as noise enclosures, reactor buildings or a block house etc. within the **HV** compound.

5.3 *Danger Notice(s)* shall be attached to **Equipment** and structures adjacent to the demarcated work area, in sufficient numbers to be clearly visible from all sides. Refer to Appendix B. The **Senior Authorised Person** has the option to utilise free standing **Danger** signs as an alternative.

5.3(a) Where reasonably practicable boundary marking shall be arranged so that all structures supporting any **Live Equipment** are excluded from the demarcated work area.

Where this is not reasonably practicable precautions against unsafe access shall be taken. Unsafe access shall be clearly identified by attaching sufficient *Access Prohibition Notice(s)* visible from all directions of approach to the **Equipment** and structures at a level beyond which it is unsafe to pass to warn people of **Danger**. Refer to Appendix B.

Testing Notice Sleeves etc. are required when Testing is carried out under Management Procedure NSI 9 – “Testing HV Equipment” or under an **Approved** restoration of motive power procedure (ROMP).

5.3(b) If via a **Senior Authorised Person** Risk Assessment it is deemed that the nature of the work e.g. Weedkilling across the whole substation, pest control or floor cleaning within a substation; does require a **Limited Access Certificate**. It may not be practical to demarcate the whole substation, part of it or indeed any of it.

NSI 6
6.1 to 6.4

6 Additional / Alternative Demarcation of Work Areas on Gas Insulated Switchgear (GIS)

- 6.1 Where reasonably practicable the demarcation requirements for establishing a work area; when working in a GIS Substation shall follow the processes described in Rule / Guidance 5.1 to 5.3 as first preference.
- 6.2 Where it is not reasonably practicable to utilise the demarcation methodology described in Rule 5.1 to 5.3; then the **Senior Authorised Person** may further Risk Assess the demarcation requirements stated in Rule 5.1 & 5.3, due to limitations in the work space / area or the design of the GIS **Equipment** within the GIS Substation.
- 6.3 Where the work includes internal access to GIS **Equipment**; then the following additional demarcation requirements to Section 6.1 and 6.2 shall be used:
- Self-fixing boundary markers around a gas barrier with a red stripe indicating the danger side, a green stripe indicating the safe side, separated by a white stripe.
 - *Designated Gas Zone Access Point Notice(s)* attached, by suitable means, to all required access points above atmospheric pressure.
 - *Vented Gas Zone Access Point Notice(s)* attached, by suitable means, to all required access points where the gas zone has been vented.
- 6.4 Where the work in a GIS Substation includes ongoing work area changes, to be completed in stages, due to the GIS **Equipment** design, it is permissible to have a staged demarcation plan risk assessed by a **Senior Authorised Person**.

Guidance
NSI 6
6.2

6 Additional / Alternative Demarcation of Work Areas on Gas Insulated Switchgear (GIS)

- 6.2 Where by design or due to space limitations some of the standard demarcation utilised for AIS substations is not deemed practicable to undertake the work safely; the **Senior Authorised Person** can risk assess the work area demarcation to ensure a designated work area is in place. Deviation from some of the standard demarcation utilised for AIS substations is permitted.
- 6.2(i) Where such limitations occur, clearly indicating the safe working area is still the main priority, however if risk assessed by a **Senior Authorised Person**, alternative demarcation (poles & smaller green cones), supplied via an existing National Contract provider similar to that depicted in fig 6.2a below can be used.



Fig 6.2a (images are for illustration purposes only)

Note: All Safety Notices shall be in place and Testing Area signage and sleeves are still required to be utilised when required.

Guidance
NSI 6
6.2 Cont to 6.3

6.2(ii) Should it be deemed necessary, via a **Senior Authorised Person** risk assessment, then the Safety Notices depicted in Appendix E can also be resourced with variations of different fixings to suit the environment being worked in. For example:

- the Safety Signs could be attached by magnets or magnetic strips
- the Safety signs could be wrap around with Velcro fastenings
- plastic 'stick on' / magnetic hooks or clamps could be used to accommodate signage.

Note: As long as all wording, symbols or diagrams stay the same as those depicted in appendix E; then all suitable signs or their fixings utilised so that the Safety Signs will remain in place during the course of work will be deemed compliant.

6.2(iii) If due to design / limited space and the demarcation equipment described in 6.1 or 6.2 is unable to be used. Then via a **Senior Authorised Person** risk assessment, cones and chains, **rope** or barriers may not be required and the most appropriate demarcation to be utilised may be:

- a transparent demarcation curtain shall be attached to the front and rear of the **Equipment**, either side of the point of work. The green horizontal arrows shall point inward to the **Equipment** where work is being carried out, and
- *Danger Notice(s)* shall be fixed to any other adjacent **Equipment** that presents **Danger** or foreseeable risk, in sufficient numbers so as to be visible from the work area at all times.
- Access and Testing notices shall be used.

Note: Should this demarcation arrangement be used, it should not affect the operation of the adjacent **Equipment** or create a risk of tripping the adjacent **Equipment**.

6.2(iv) Should the design of the **Equipment** or the location of it, such as under a walkway or gantry, make it impractical to use any standard cones / poles to attach chain / **rope** / barriers, as described in Rule 5.3 or those in Guidance 6.2(a). Then via a **Senior Authorised Person** risk assessment, the cones may be replaced by a more suitable means of attaching the chains / **rope** / barriers to delineate the work area. This could be, but not limited to:

- plastic 'stick on' / magnetic hooks or clamps that fix the chain / **rope** / barriers to handrails or supporting structures.

Note: Green cones, Access, Safety and Testing Notices shall always be used. NOT utilising cones for affixing chains / **rope** / barriers is a last resort option. The priority is still to delineate a work area that is recognisable and understood by all relevant parties that may be affected.

6.2(v) Should the design of the **Equipment** or the location of it, such as under a walkway or gantry, make it impractical to use the standard *Access Point Notice* then via a **Senior Authorised Person** risk assessment, a smaller version, resourced from a National Contract provider, containing the same information is permissible. It may be affixed differently but needs to be placed to ensure it is visually obvious to all relevant parties.

Guidance
NSI 6
6.4 Cont

- 6.4 Where the demarcation changes due to the complexity of the work being undertaken, e.g. if scaffolding is erected for staged work, then a staggered demarcation plan can be implemented using sequential risk assessments and hold points within a method statement. **Senior Authorised Person** to provide **Personal Supervision** during demarcation changes. It is acceptable to finalise some notices, agreed by the **Senior Authorised Person**, where access is not immediately available.

NSI 6
7.1 to 7.4

7 Additional / Alternative Demarcation of Work Areas on or near Metal Enclosed (HV), Low Voltage and Mechanical Equipment

Rooms on NG **Locations** that contain **Equipment** such as Air Systems, Metal Enclosed Switchgear, Diesel Generators, Relay Rooms, and those of a similar design and nature not specifically named shall follow Rule 7.1 and 7.2.

- 7.1 Where reasonably practicable the demarcation requirements for establishing a work area; shall follow the processes described in Rule / Guidance 5.1 to 5.3 as first preference.

- 7.2 Where it is not reasonably practicable to utilise the demarcation methodology described in Rule 5.1 to 5.3; then the **Senior Authorised Person** may further Risk Assess the demarcation requirements stated in Rule 5.1 & 5.3, due to limitations in the work space / area.

7.3 LV Equipment Specific

- (a) When work is to be carried out on **LV Equipment** (including any work undertaken under a **Certificate for Live LV Work**) which may or may not be in proximity to exposed **HV, LV** or Mechanical **Equipment** the requirements of Rule 5 or in the case of GIS, Rule 6 shall be adhered to.

- (b) When work is specifically carried out on a section of **LV** panels, a transparent demarcation curtain shall be attached to the front and rear of the panels, either side of the point of work. The green horizontal arrows shall point inward to the panel where the work is being carried out.

and

Danger Notice(s) shall be fixed to any other adjacent **Equipment** that presents **Danger** or foreseeable risk, in sufficient numbers so as to be visible from the work area at all times.

7.4 Mechanical Equipment Specific

- (a) When work is to be carried out on Mechanical **Equipment** which is in proximity to exposed **HV, LV** or Mechanical **Equipment** the requirements of Rule 5 or in the case of GIS, Rule 6 shall be adhered to.

- (b) When work is specifically carried out on a section of Mechanical panels, a transparent demarcation curtain shall be attached to the front and rear of the panels, either side of the point of work. The green horizontal arrows shall point inward to the panel where the work is being carried out.

and

Danger Notice(s) shall be fixed to any other adjacent **Equipment** that presents **Danger** or foreseeable risk, in sufficient numbers so as to be visible from the work area at all times.

Guidance
NSI 6
7.2 to 7.4

7 Additional / Alternative Demarcation of Work Areas on or near Metal Enclosed (HV), Low Voltage and Mechanical Equipment

7.2 Where by design or due to space limitations some of the standard demarcation utilised for AIS substations is not deemed practicable to undertake the work safely; the **Senior Authorised Person** can risk assess the work area demarcation to ensure a designated work area is in place. Deviation from some of the standard demarcation utilised for AIS substations is permitted.

The hierarchy for deviation away from standard AIS demarcation is provided in Guidance 6.2, and

When working in rooms covered in this section only; it is permissible, via a **Senior Authorised Person** risk assessment to not utilise any cones or chains / **rope** / barriers to demarcate a work area, as a last resort due to limited space. However, all Safety Notices shall still be displayed and other control measures such as limiting access or prohibiting access by the use of signage or posting safety observers at the work area may need to be applied.

Where **Danger** may arise from **Live LV** terminals, screening shall be applied in accordance with Management Procedure NSI 12 "Low Voltage Equipment"

7.3(a) Proximity to exposed **HV Equipment** includes Supplies Pillars, Marshalling Kiosks, etc. and when working on the outside of Block Houses or Reactor Houses, etc. within the **HV** compound.

For all **LV** work including work under a **Certificate for Live LV Work** the **Senior Authorised Person** shall via risk assessment determine the level and quantity of demarcation required.

7.3(b) Should this demarcation arrangement be used, it should not affect the operation of the adjacent **Equipment** or create a risk of tripping the adjacent **Equipment**.

7.4(a) Proximity to exposed **HV Equipment** includes Supplies Pillars, Marshalling Kiosks, etc. and when working on the outside of Block Houses or Reactor Houses, etc. within the **HV** compound.

Where **Danger** may arise from **Live LV** terminals, screening shall be applied in accordance with Management Procedure NSI 12 "Low Voltage Equipment"

7.4(b) Should this demarcation arrangement be used, it should not affect the operation of the adjacent **Equipment** or create a risk of tripping the adjacent **Equipment**.

NSI 6
8.1 to 8.3

8 Demarcation of Risk Management and General Hazard Zone(s)

- 8.1 Risk Management Hazard Zone(s) subject to a risk management procedure shall be designated by:
- Yellow cones
 - Yellow and black plastic chain, **rope** or rigid barriers
 - *Risk Management Hazard Zone Notice(s)* attached to the chain / **rope** or barriers
 - Provision of any required pedestrian / vehicle access points based on a risk assessment e.g. controlled lowering of chains or barriers – managed via 'T' card process.
- 8.2 Information on the Risk Management Hazard Zone(s) shall be recorded at the **Location**.
- 8.3 General Hazard Zone(s) shall be designated by:
- Yellow cones
 - Yellow and black plastic chain or rigid barrier e.g. Heras fence / crowd barriers
 - Provision of any required pedestrian / vehicle access points based on a risk assessment e.g. controlled lowering of chains or barriers – managed via 'T' card process.

Guidance
NSI 6
8.1 to 8.2

8 Demarcation of Risk Management and General Hazard Zone(s)

- 8.1 All demarcation, shall where reasonably practicable, be carried out in accordance with the standards shown in Appendix C. Risk Assessment to be filed in accordance with the 'T' card process – 15 drawer cabinet or notice board.
- Where there is a requirement for ballistic screening (e.g. scaffold and ballistic netting, shipping containers, etc.), that in itself along with appropriate signage may be used to demarcate a Risk Management Hazard Zone.
- 8.2 Details to be recorded on the Substation Status Board. Risk Assessment to be filed in accordance with the 'T' card process – 15 drawer cabinet or notice board..

NSI 6
9.1 to 9.5

9 Roles & Responsibilities – Demarcated Work Areas

9.1 The **Senior Authorised Person** shall risk assess whether demarcation is required for work carried out under a **Limited Access Certificate**.

9.2 Where a work area is to be demarcated:-

(a) The **Senior Authorised Person** shall instruct a **Competent Person** authorised to full NSI 6 and 8 on the positioning of the demarcation equipment. Demarcation equipment shall then be erected by the **Competent Person** or by a **Person** under the **Personal Supervision** of the **Competent Person**

Demarcation shall be:-

- Erected after **all** safety precautions have been established but before any **Safety Document(s)** is issued
- Removed after clearance of the **Safety Document(s)** but before cancellation

(b) The **Senior Authorised Person** issuing the **Safety Document** shall ensure that the designated work area has been demarcated correctly by the **Competent Person** before issuing the **Safety Document**

(c) Entry to a demarcated area is only permitted by a member of the **Working Party** under the terms of the **Safety Document**.

9.3 Before work commences, the **Safety Document** recipient shall undertake an inspection of the demarcation equipment to confirm its continuing suitability. The **Safety Document** recipient shall then enter their name and the date on the *Access Point Notice*.

It is permissible for the **Safety Document** recipient to stand up a cone or reaffix a chain / **rope** / barrier that has accidentally fallen to ground. If there has been significant disruption to the demarcation equipment then a **Senior Authorised Person** shall be contacted prior to its re-instatement.

9.4 No **Personnel** shall enter or exit a demarcated work area by crossing over or under any chain, **rope** or barrier. A designated access point shall be used.

9.5 The **Safety Document** recipient identified on the *Access Point Notice* is permitted to dismantle chains, **ropes**, cones or barriers at the designated vehicle access point(s) to allow access / egress of plant and vehicles.

The chains, **ropes**, cones or barriers at the designated vehicle access point(s) shall be restored immediately once the plant / vehicles have entered or left the work area.

The designated vehicle access point(s) shall be identified on site by the positioning of a *Vehicle Access Point Notice* only, between the two cones identified as the vehicle access point.

NSI 6
9.6 to 9.7

- 9.6 If there is more than one **Safety Document** in force for one specific demarcated work area, it will only be necessary for one of the **Safety Document** recipients to complete the requirements of 9.3. There shall be mutual agreement between the **Safety Document** recipients.
- 9.7 When testing is to be carried out, the **Safety Document** recipient shall ensure that all *Testing Notice* sleeves, *Testing Area No Entry Notice(s)* are correctly displayed and “access / egress” point(s) closed before the testing commences. These shall be removed upon completion of the test.

Guidance
NSI 6
9.1 to 9.6

9 Roles & Responsibilities – Demarcated Work Areas

- 9.1 Where reasonably practicable a **Limited Access Certificate** work area shall be demarcated, especially inside an **HV** compound.

Examples of when it may not be reasonably practicable to erect demarcation is where the work takes place across the whole **HV** compound such as when spreading weed killer or when doing non-intrusive ground surveys for buried services.

- 9.3 An example of significant disruption is where there have been strong winds overnight and the boundary of the demarcated work area has been substantially blown over to the extent that it is not clear where the cones / chain, **rope** or barriers should be re-erected etc.

- 9.5 If the **Senior Authorised Person** decides to utilise a designated vehicle access point, this shall be clearly identified to the **Competent Person** on a sketch and incorporated in the RAMS.

- 9.6 When there is more than one **Working Party** working in a single demarcated work area, the first **Safety Document** recipient to start work in the demarcated work area each day shall complete the requirements of 9.3.

When more than one **Working Party** is set to work, the **Senior Authorised Person** shall ensure co-ordination between each **Working Party** is established, ensuring all activities that could affect another **Working Party** are considered. Where appropriate this shall be recorded on all toolbox talk forms. During the work it is each **Competent Person's** responsibility to ensure adequate co-ordination is maintained.

NSI 6
10.1 to 10.2

10 Roles & Responsibilities - Risk Management and General Hazard Zone(s)

- 10.1 A **Competent Person** authorised to full NSI 6 and 8 working to instructions of a **Senior Authorised Person** can erect / remove demarcation of *Risk Management Hazard Zone(s)*.

- 10.2 A **Competent Person** authorised to full NSI 6 & 8 can erect / remove demarcation of General Hazard Zone(s).

NSI 6
11.1 to 11.2

11 Contractor's Work Area Demarcation

- 11.1 The Contractor's work area shall be discussed and agreed with the National Grid **Senior Authorised Person** and / or Project Lead prior to the commencement of works.
- 11.2 Where it is identified that the Contractor's work area will be the same physical size as the Safety Rule demarcation work area. The **Senior Authorised Person** can use either:
- (a) Safety Rule demarcation
or
 - (b) Contractor's demarcation
- 11.3 When a demarcated Safety Rules work area is required, for Cat 1 or 3 work, within a Contractor's work area it shall be clearly defined and distinguishable to avoid confusion with the general Contractor's work area, as determined by the **Senior Authorised Person**.

Guidance
NSI 6
11.1 to 11.2

11 Contractor's Work Area Demarcation

- 11.1 All delineated Contractor work areas, unless specifically stated, shall by default be considered as Construction, Design and Management (CDM) Regulations demarcation.
- Contractor's demarcation may be used to define the limits of a work area under a **Limited Access Certificate** but only when the limits of work can be clearly specified on the **Limited Access Certificate** as a means of achieving **Safety from the System**.
- 11.2 Where it is clearly identified that the Contractor's work area will be the same physical size as the Safety Rule demarcation work area it is not appropriate to double delineate.
- 11.2(a) The **Senior Authorised Person** will agree with the Principle Contractor that the Safety Rule demarcation can be used to define the Contractor's work area. (Appendix D2 – Example 1)
- 11.2(b) The **Senior Authorised Person** will agreed with the Principle Contractor the positioning and type of Contractor's demarcation that can be used. Entry point Safety Rules demarcation, shall be used. (Appendix D2 – Example 2)
- The method and standards of demarcation for a Contractor's work area are subject to the CDM Regulations and are the responsibility of the Principal Contractor and shall be appropriate to the levels of risk associated with the construction work.
- The Contractor's work area (as depicted in Appendix D3)
- 11.3 Where a demarcated Safety Rules work area is required within a Contractor's work area, then an independent Safety Rules work area shall be established to clearly demonstrate that a Safety Rules work area under a **Permit for Work** exists.
- A staged demarcation plan may form part of the RAMS to determine any changing demarcation needs throughout the project.
- The delineation used for the Contractor's work area may be considered as fixed barriers and therefore used to form part of the Safety Rules demarcated work area.

Appendix A – Examples of NSI 6 Demarcation Drawings

Notes:

1. Drawing can be in any format e.g. marked-up photocopy of layout drawing, hand drawn etc. but must clearly show the position of demarcation equipment and the location of the work area relevant to nearby **Live Equipment**.
2. Positions of demarcation equipment must be clearly shown on the drawing e.g. use of dimensions or shown positioned against clear fixed objects e.g. trenches, fences, **Equipment** structures etc.
3. Plan and Elevation drawings may be required e.g. for GIS work areas or where overhead **Live Equipment** needs to be identified / demarcated.
4. If a sketch is used additional details / information can be placed in the RAMS.
5. NSI 6 & 8 combined drawings are allowed as long as they have all the detailed information included.

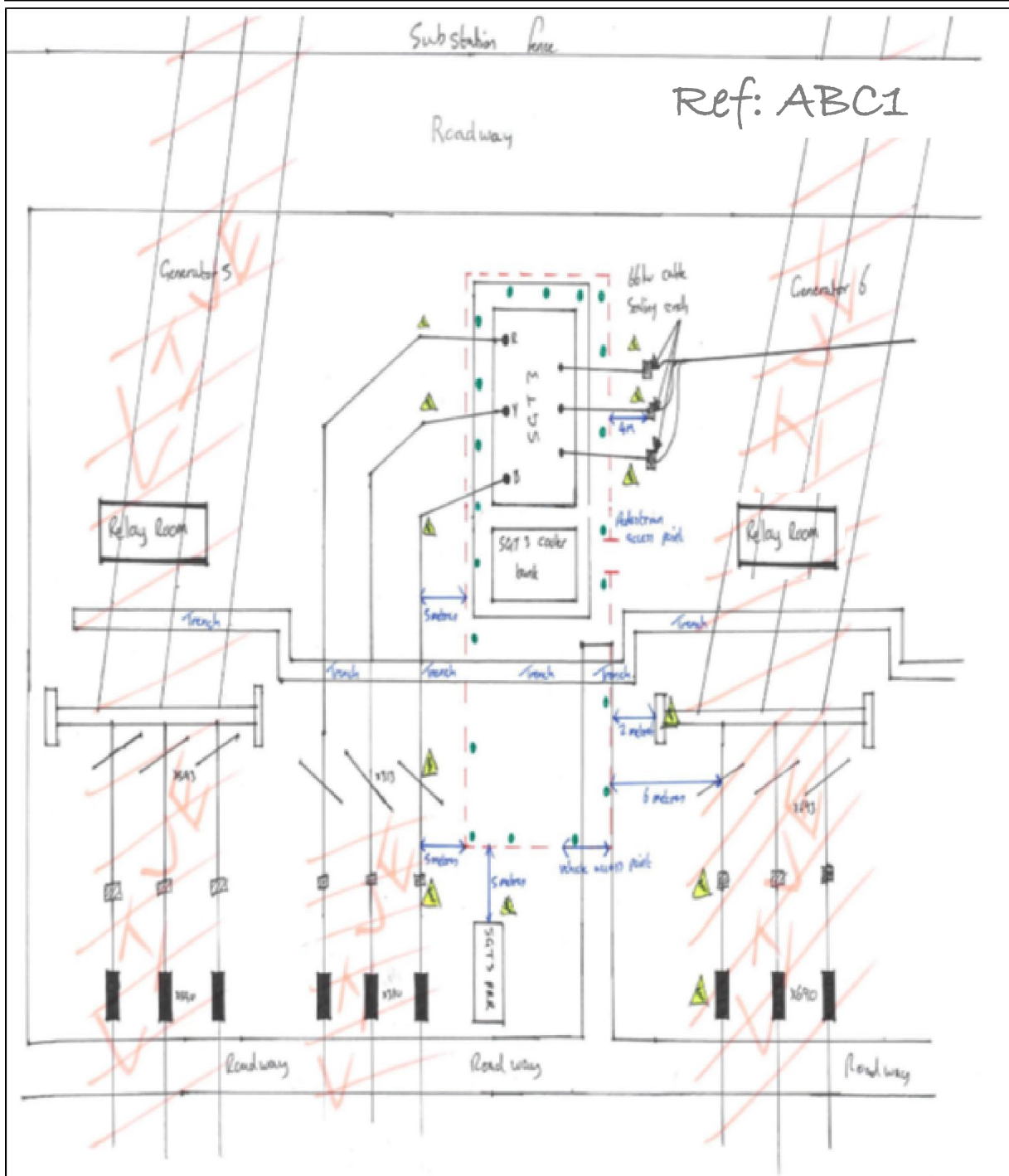

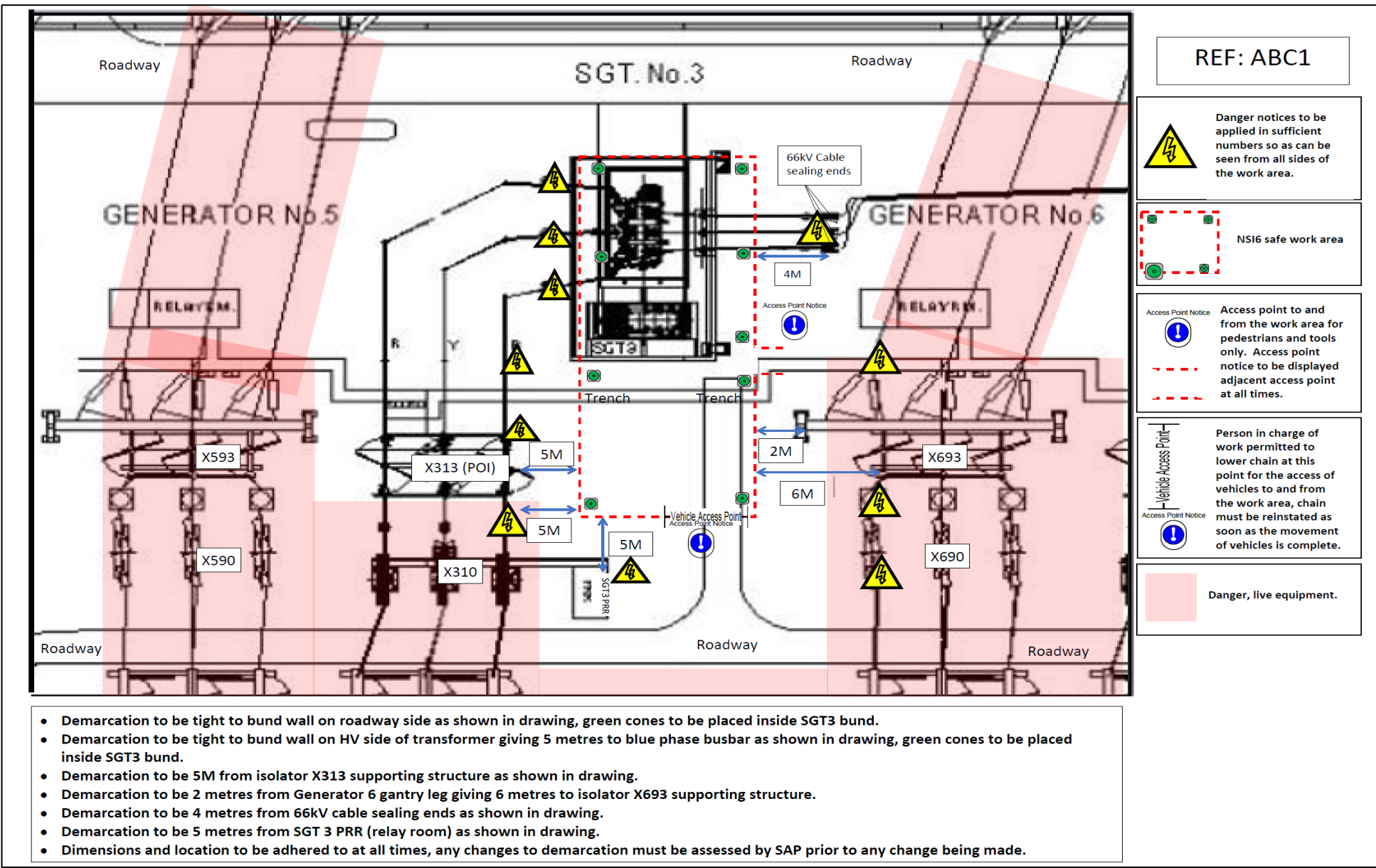

Appendix B – Examples of Demarcation for Work Areas B1 – Permit for Work

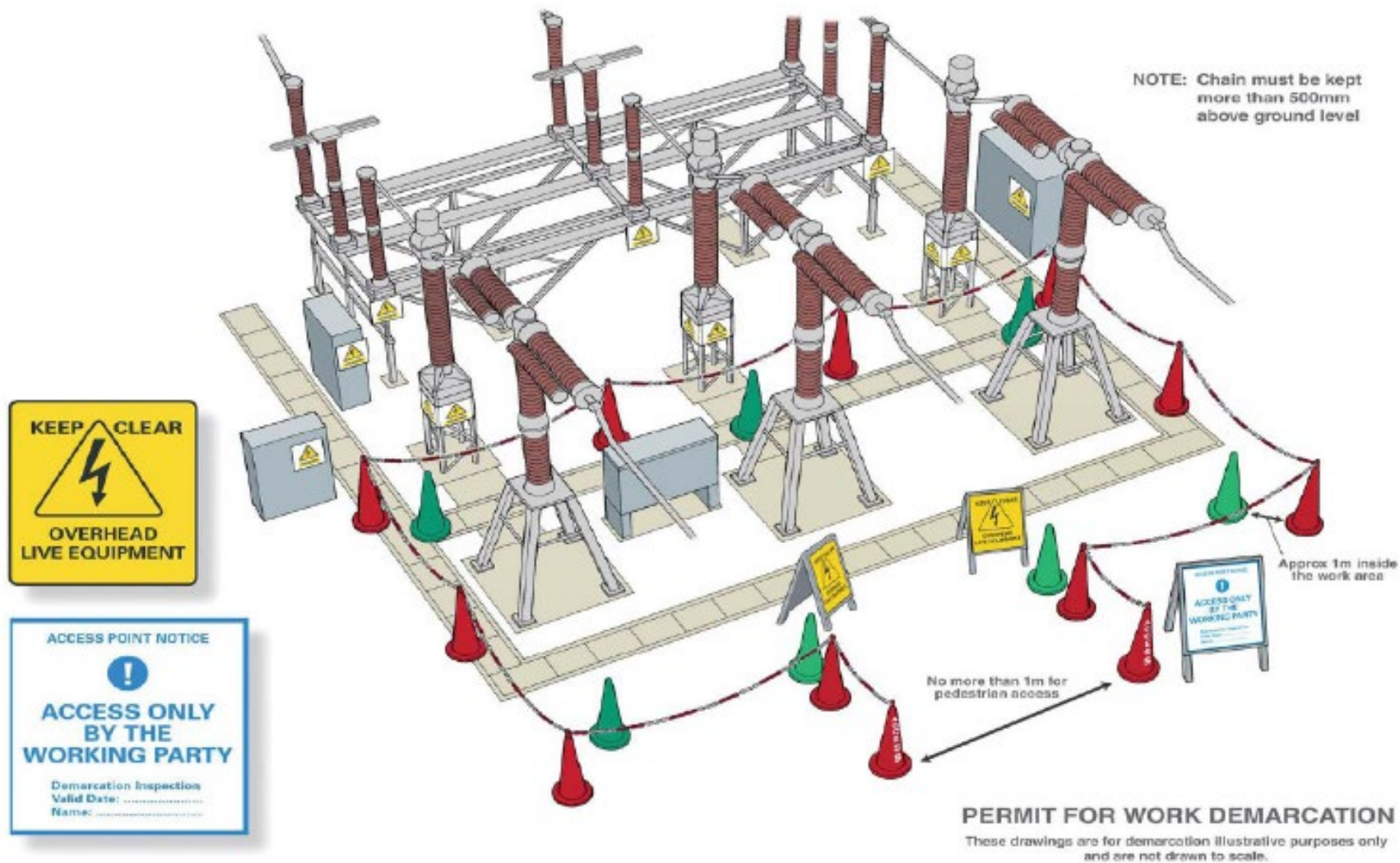

B2 – Permit for Work – Testing Area

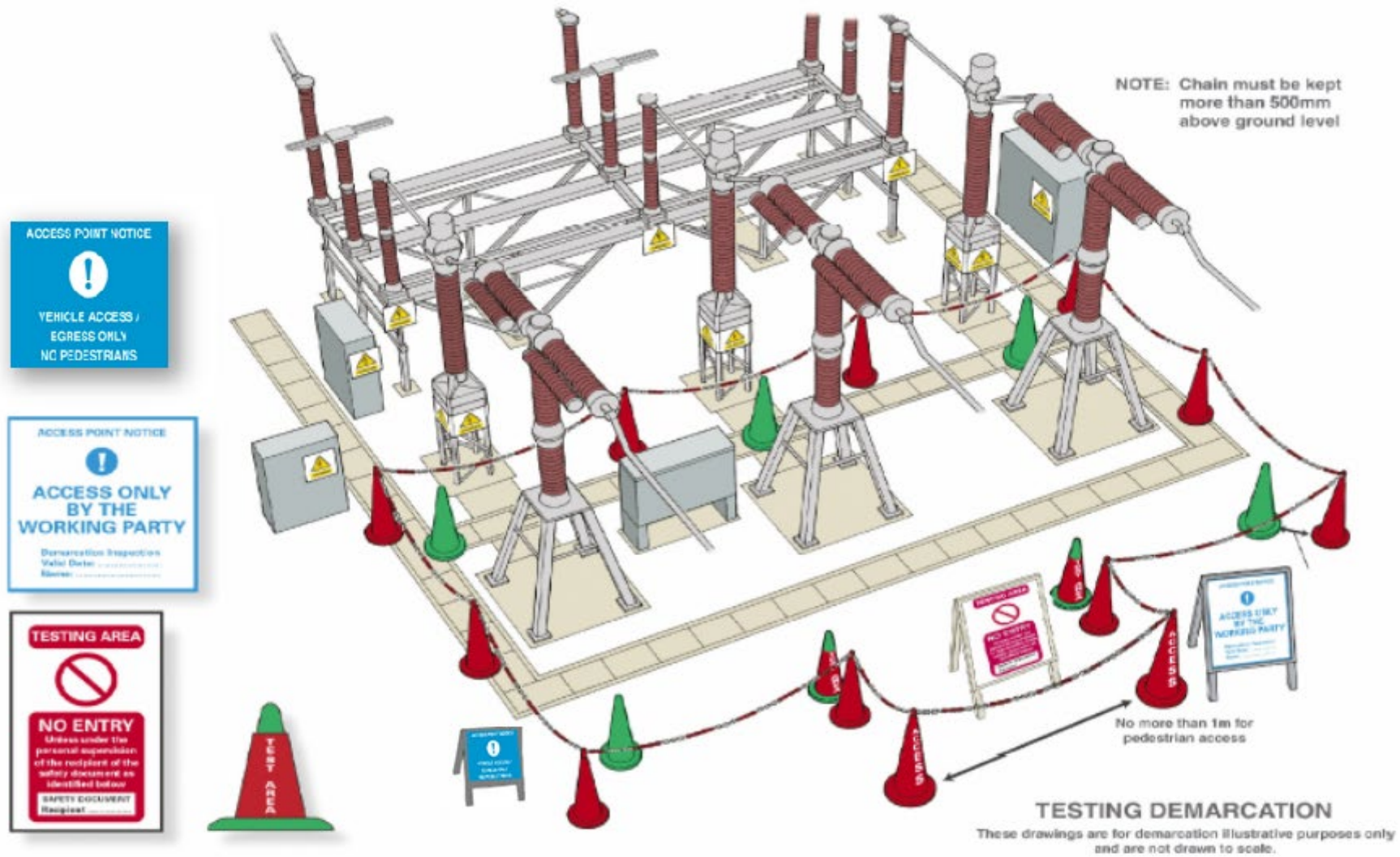

B3 – Limited Access Certificate

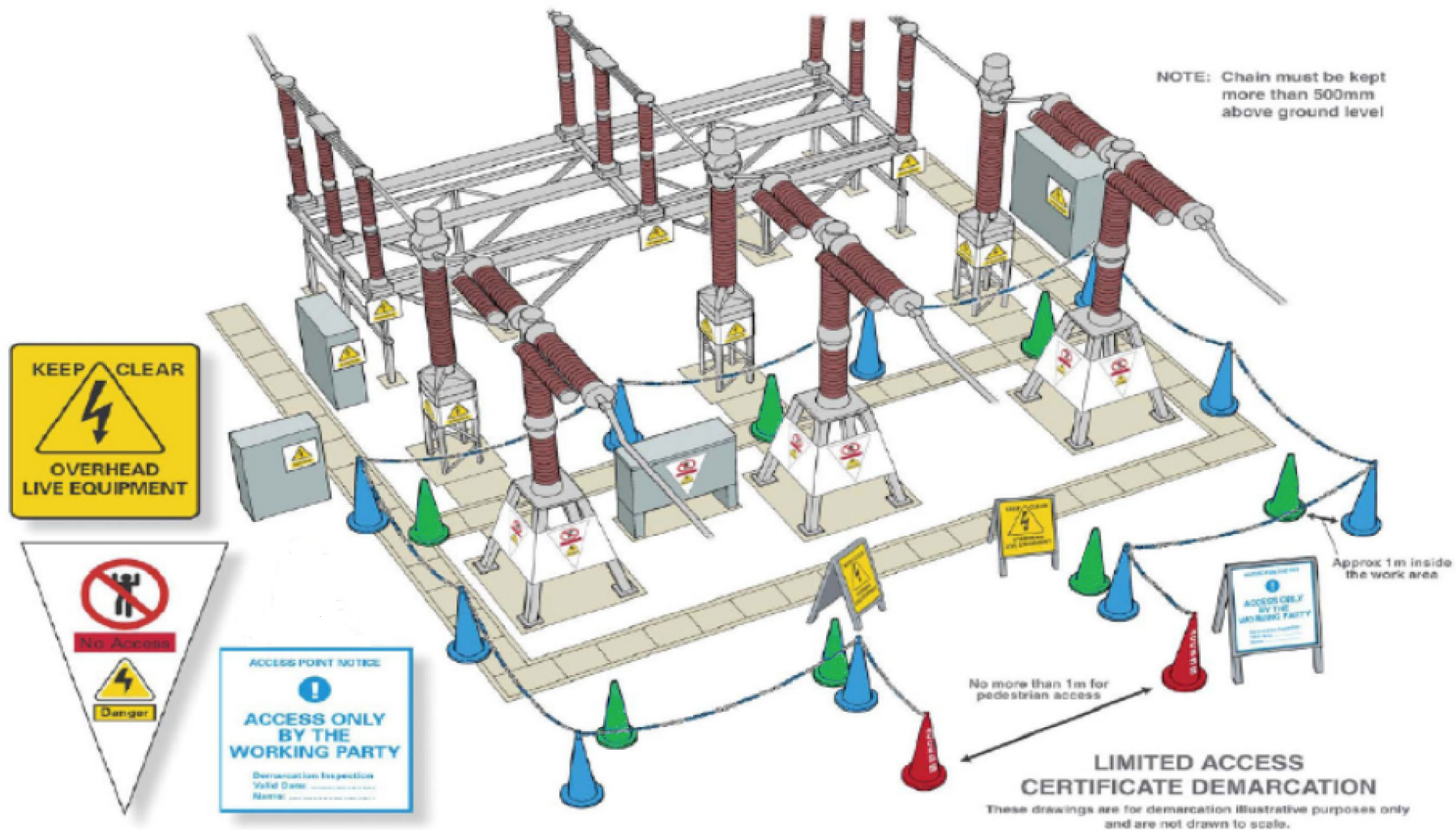

B4a – Where a Natural Fence Already Exists



NOTE: If similar components are immediately adjacent to the one being worked on, 'Danger' notices would be affixed to the outside of the gates of the other compounds.

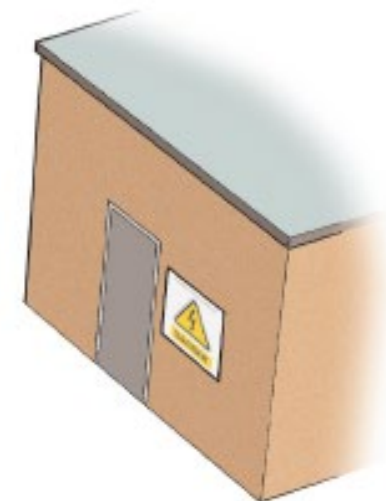

WHERE A FIXED FENCE ALREADY EXISTS

These drawings are for demarcation illustrative purposes only and are not drawn to scale.

B4b – Where a Natural Fence Already Exists

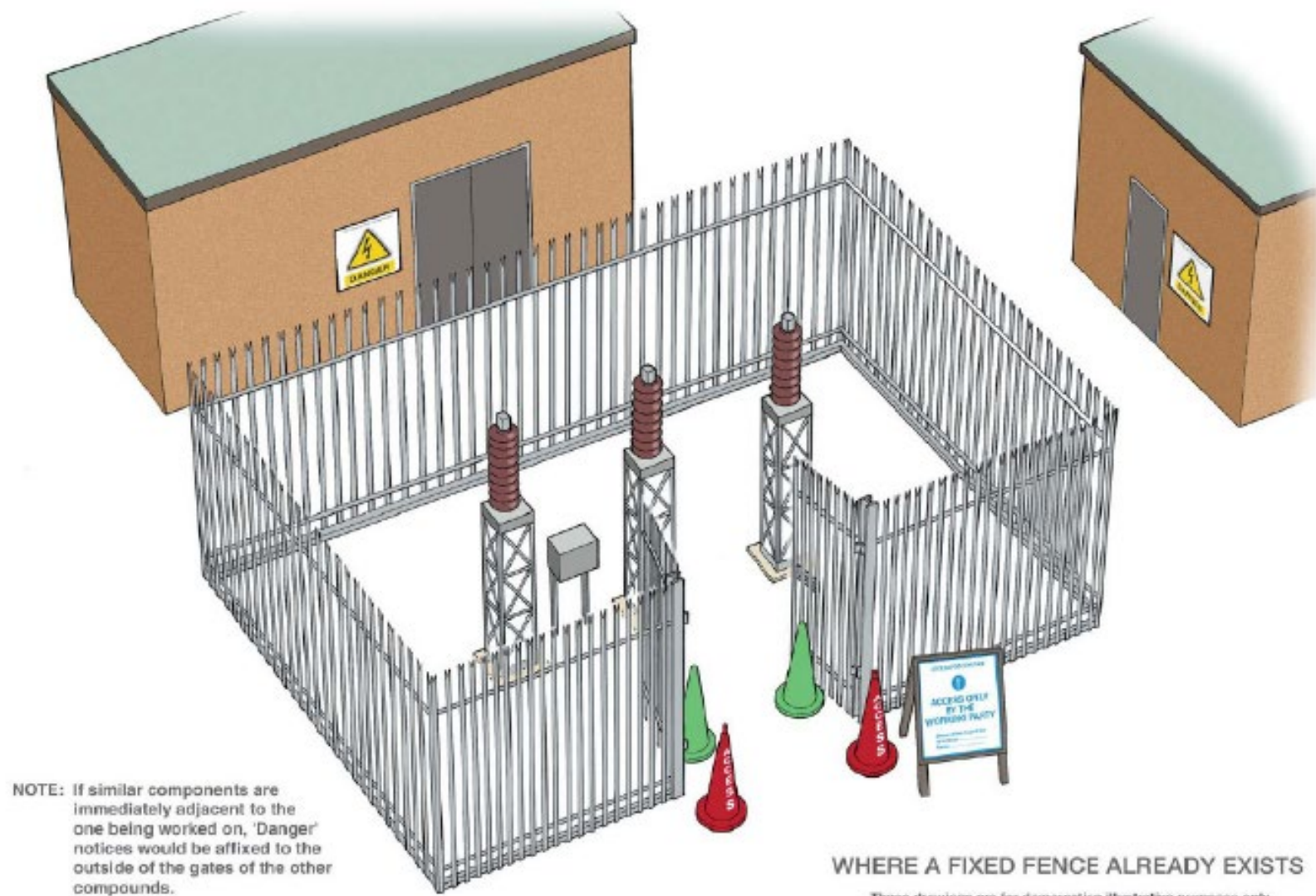

B4c – Where a Natural Fence Already Exists

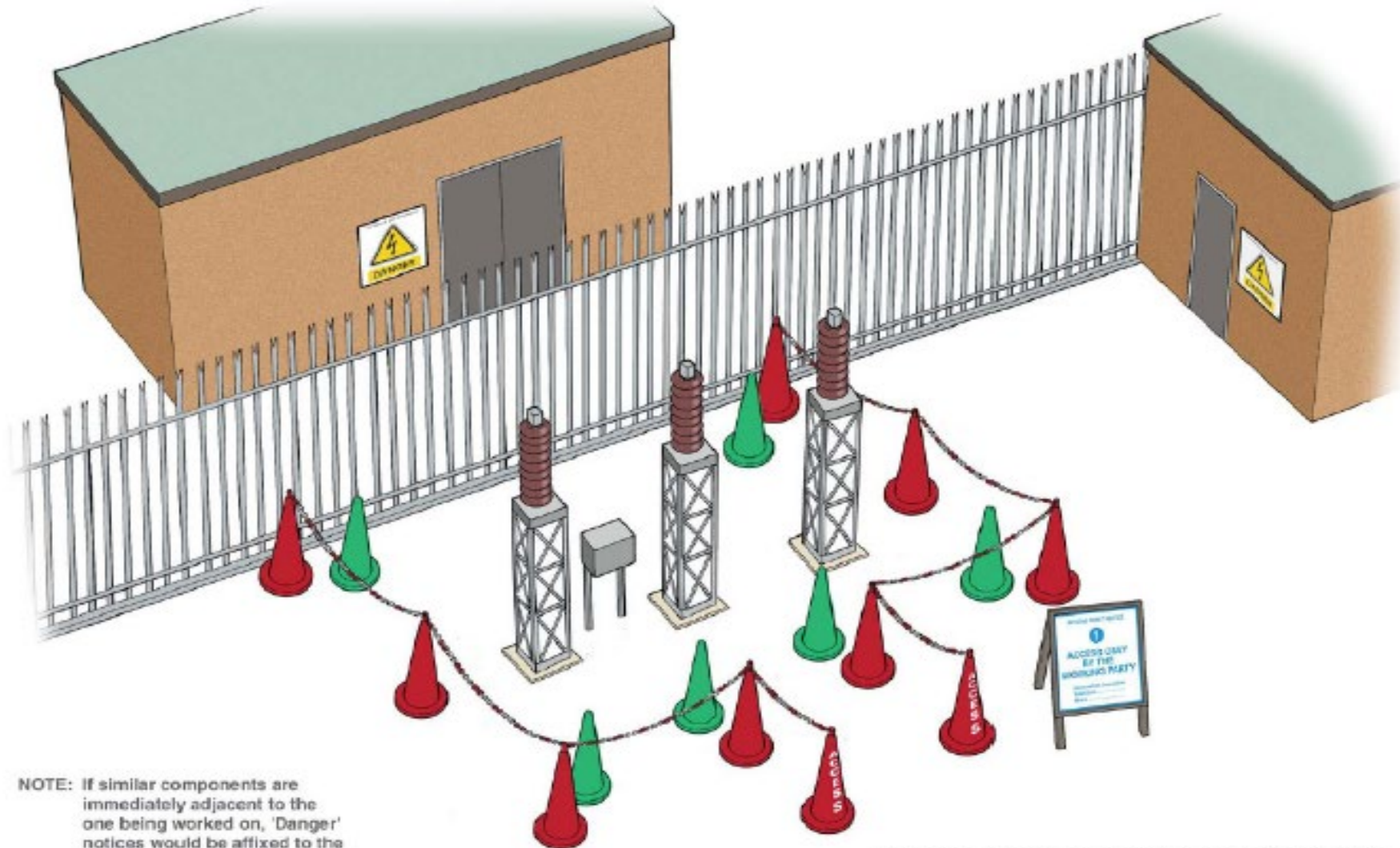

NOTE: If similar components are immediately adjacent to the one being worked on, 'Danger' notices would be affixed to the outside of the gates of the other compounds.

WHERE A FIXED FENCE ALREADY EXISTS

These drawings are for demarcation illustrative purposes only and are not drawn to scale.

B5a – Gas Insulated Switchgear

NOTE: Gas zone access point notice displaying a mandatory symbol allowing access after depressurisation and purging of compartment.

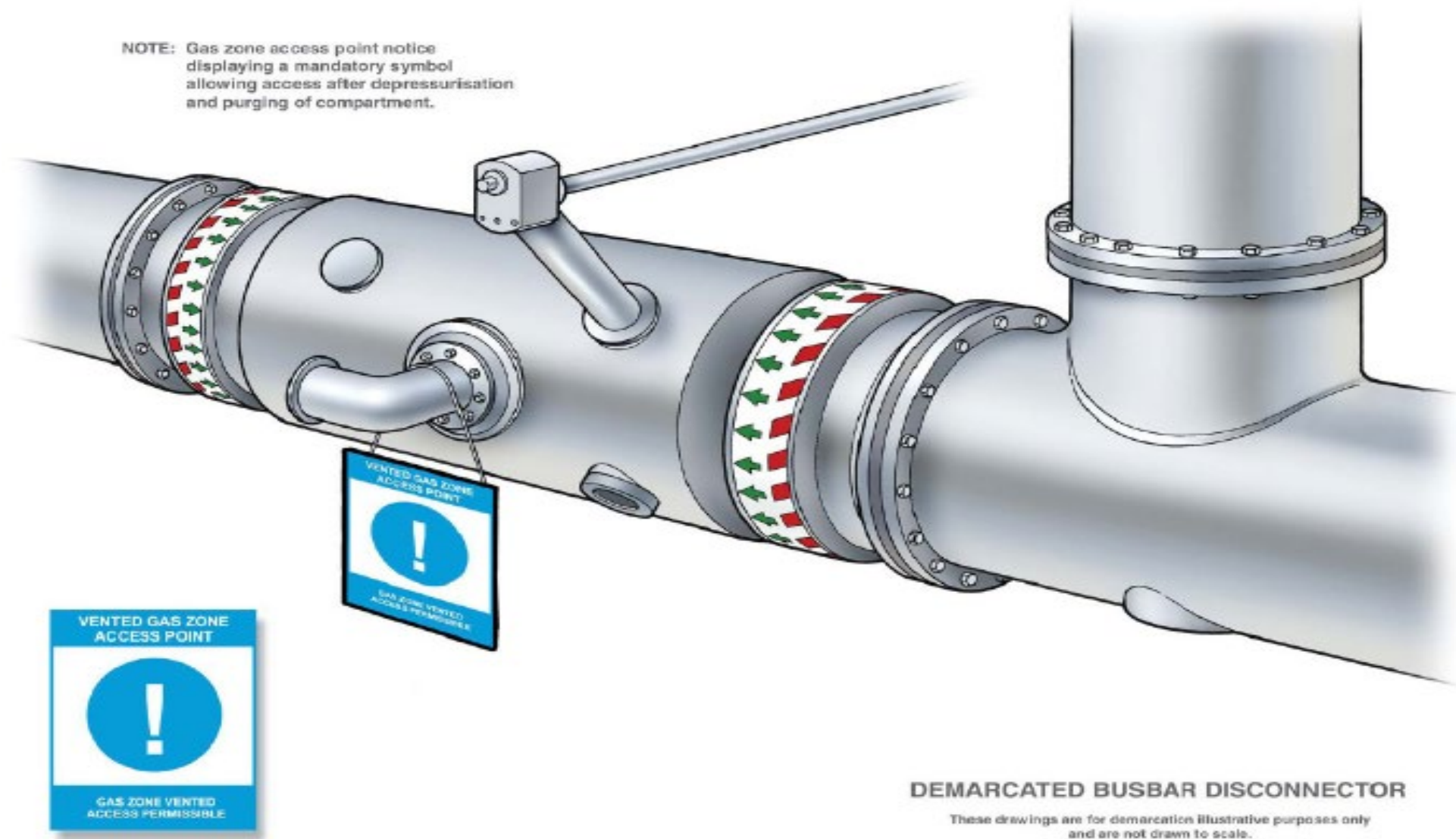

B5b – Gas Insulated Switchgear

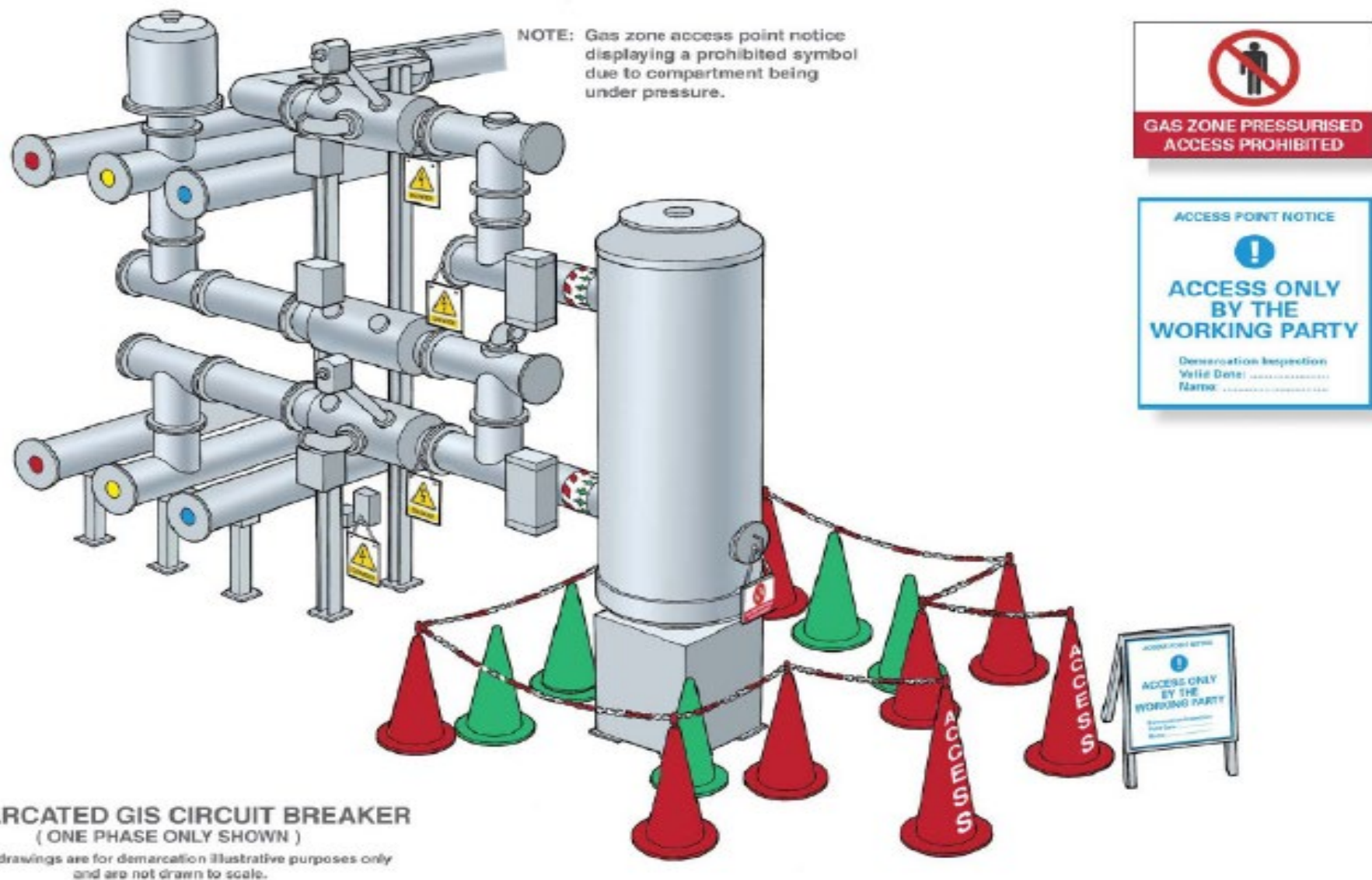

B6a – Low Voltage Equipment

NOTE: Similar demarcation at rear of panel

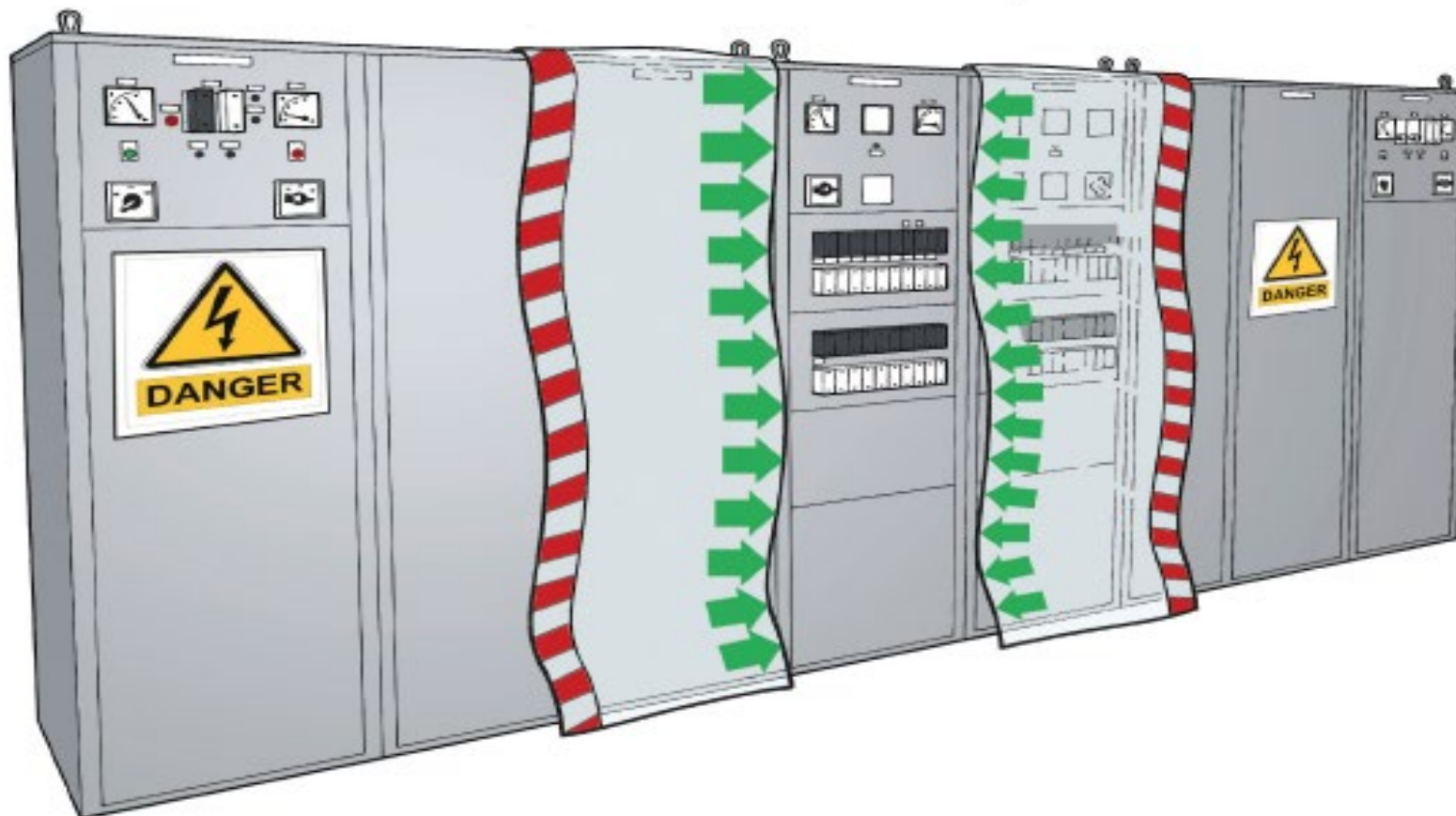

50 VOLT DISTRIBUTION BOARD

These drawings are for demarcation illustrative purposes only
and are not drawn to scale.

B6b – Low Voltage Equipment

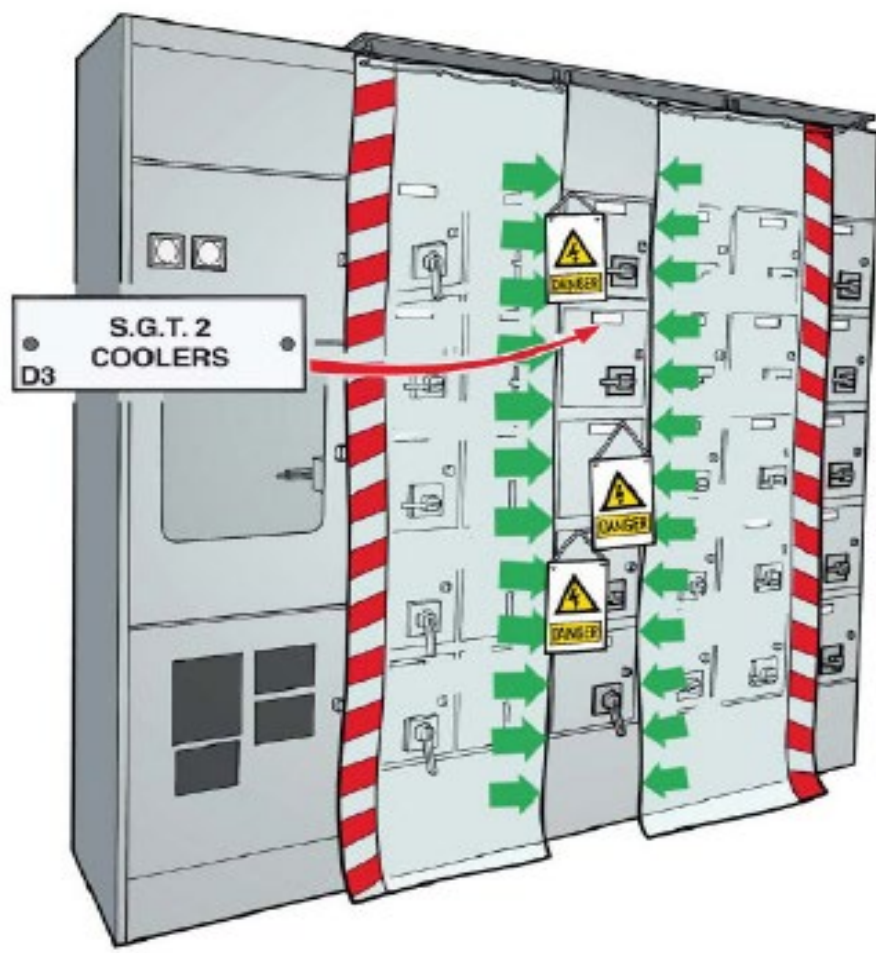
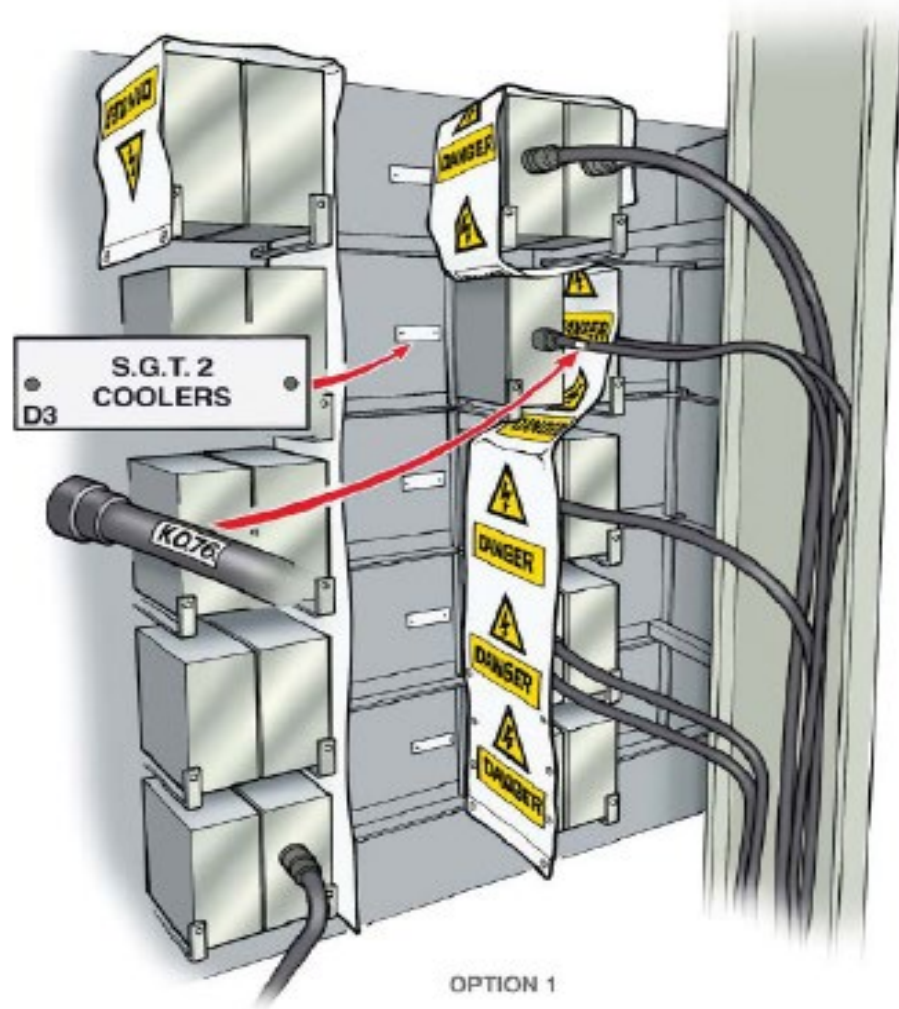

INSTALLATION OF S.G.T. 2 COOLER SUPPLY

These drawings are for demarcation illustrative purposes only
and are not drawn to scale.

B6c – Low Voltage Equipment

NOTE: An example of danger tape preventing accidental removal of wrong terminal connections

Danger tape or danger signs may be used in this situation

Where danger may arise from these terminals, screening material must be used

Rack being worked on

INSTALLATION OF A NEW TERMINAL RACK

These drawings are for demarcation illustrative purposes only and are not drawn to scale.

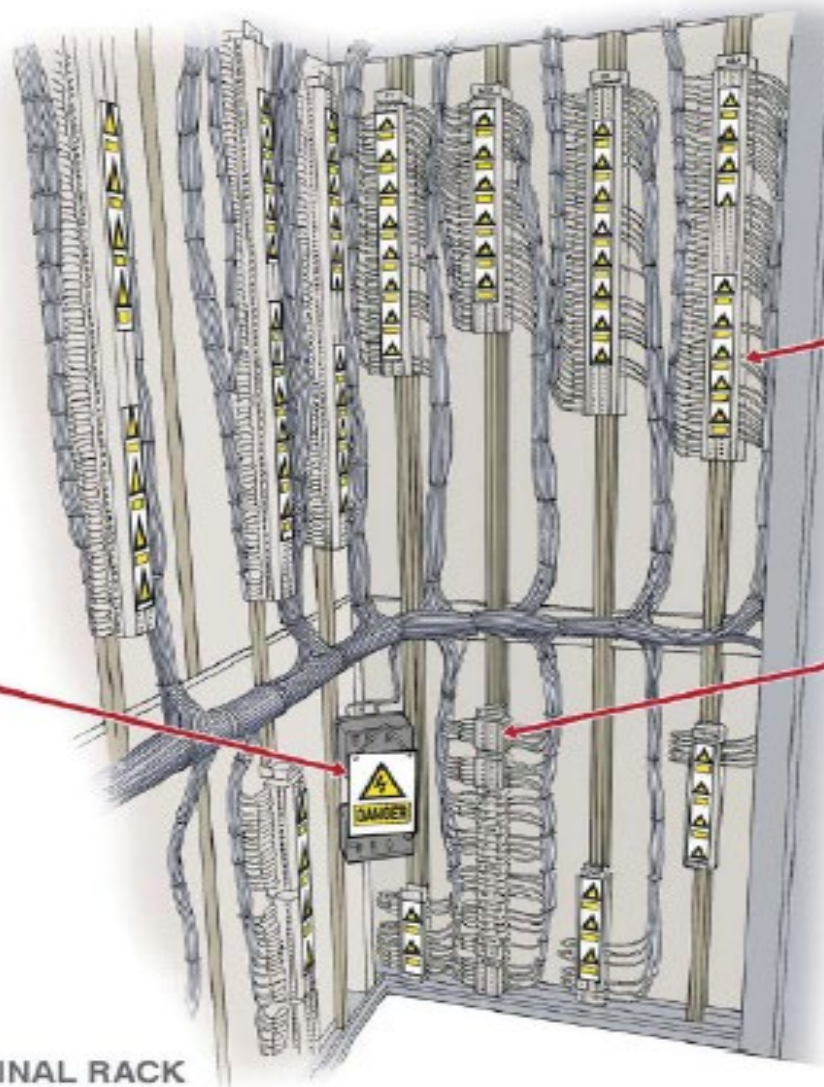

B6d – Low Voltage Equipment

NOTE: Screening material must not allow the build-up of hydrogen gas under the screening.

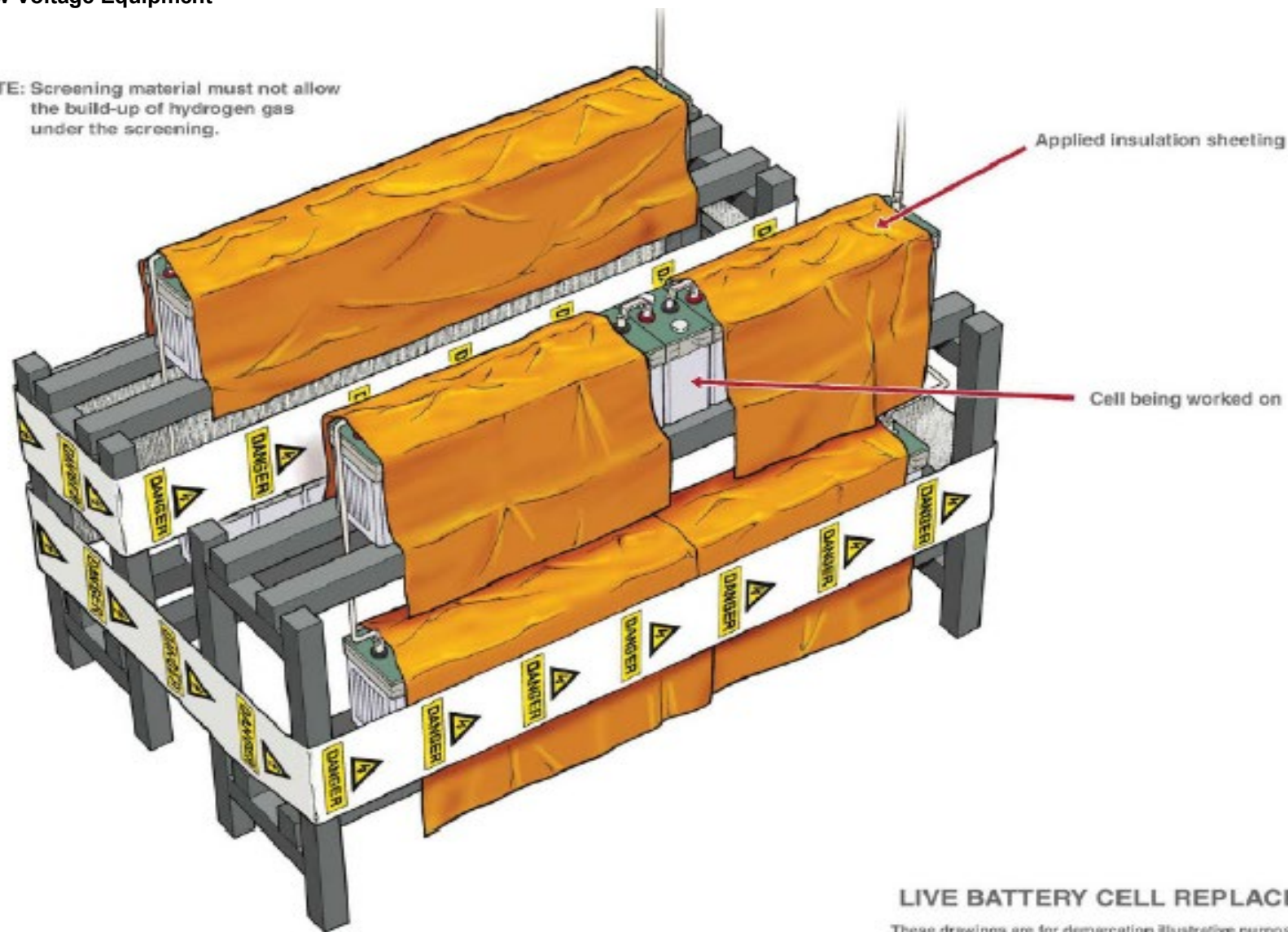

LIVE BATTERY CELL REPLACEMENT

These drawings are for demarcation illustrative purposes only and are not drawn to scale.

B7a – Mechanical Equipment

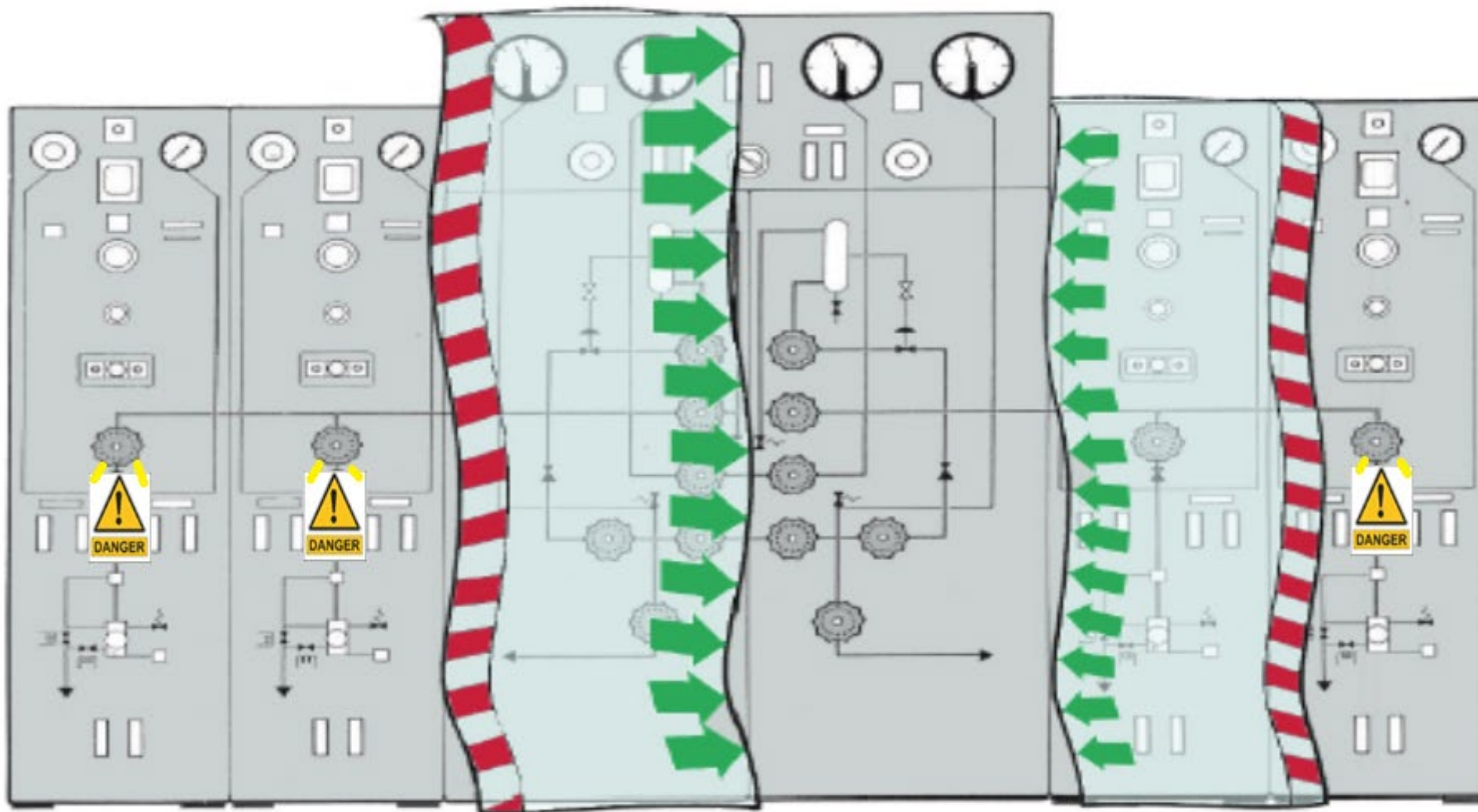

B7b – Mechanical Equipment Rear view of panel

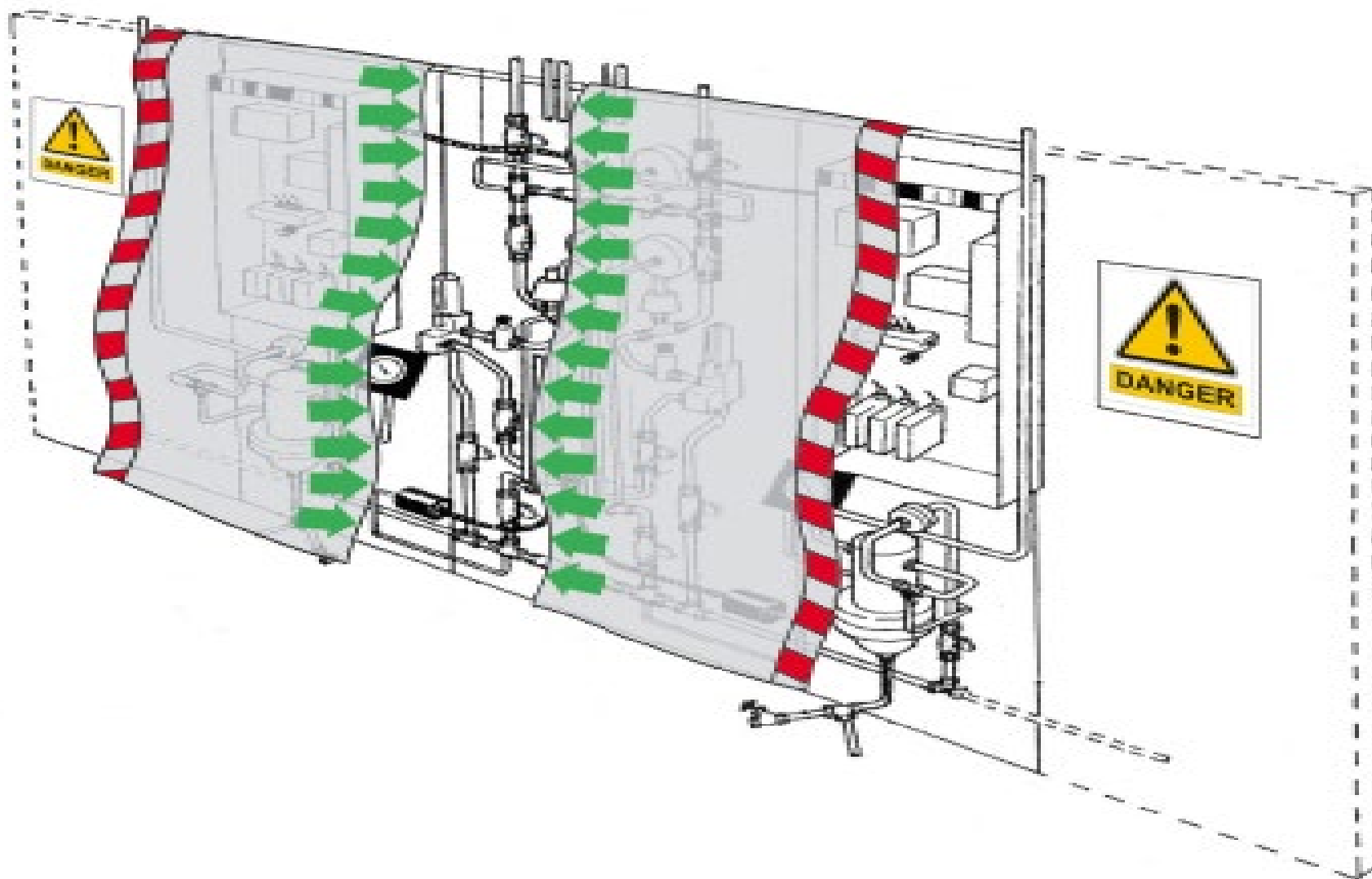

Appendix C1a – Example of Demarcation for a General Hazard Zone

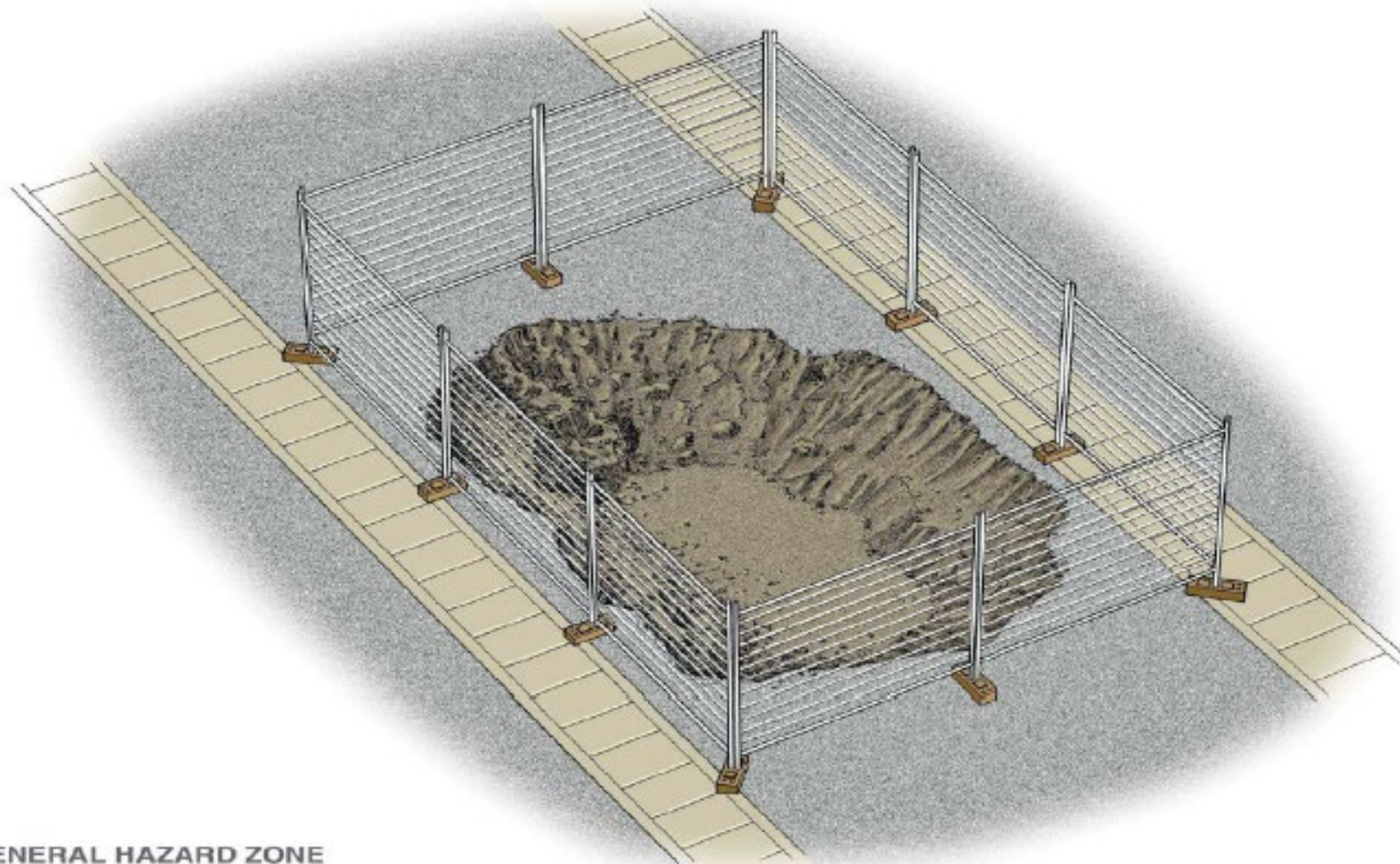

GENERAL HAZARD ZONE

These drawings are for demarcation illustrative purposes only
and are not drawn to scale.

Appendix C1b – Example of Demarcation for a General Hazard Zone

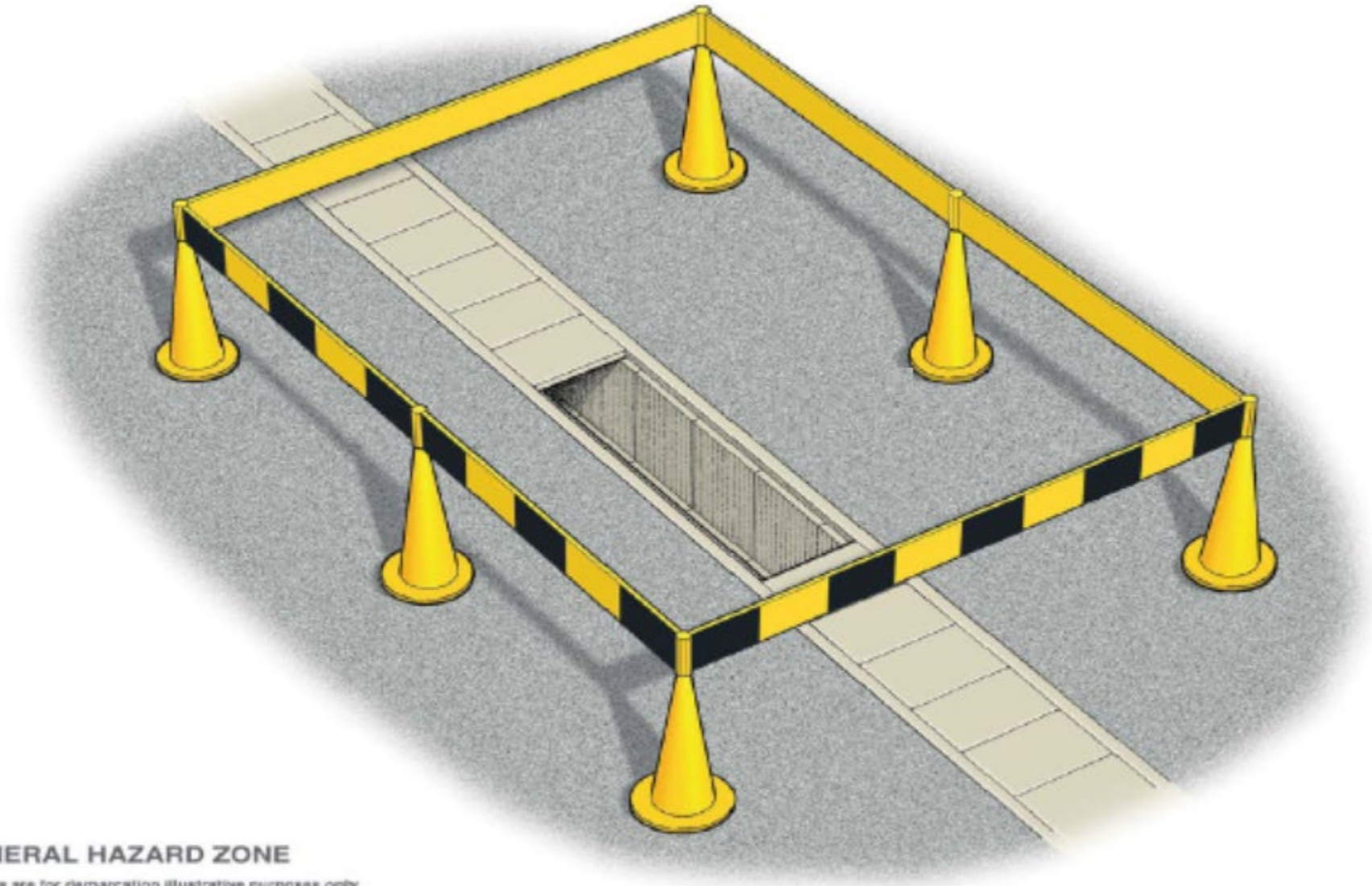



GENERAL HAZARD ZONE

These drawings are for demarcation illustrative purposes only
and are not drawn to scale.

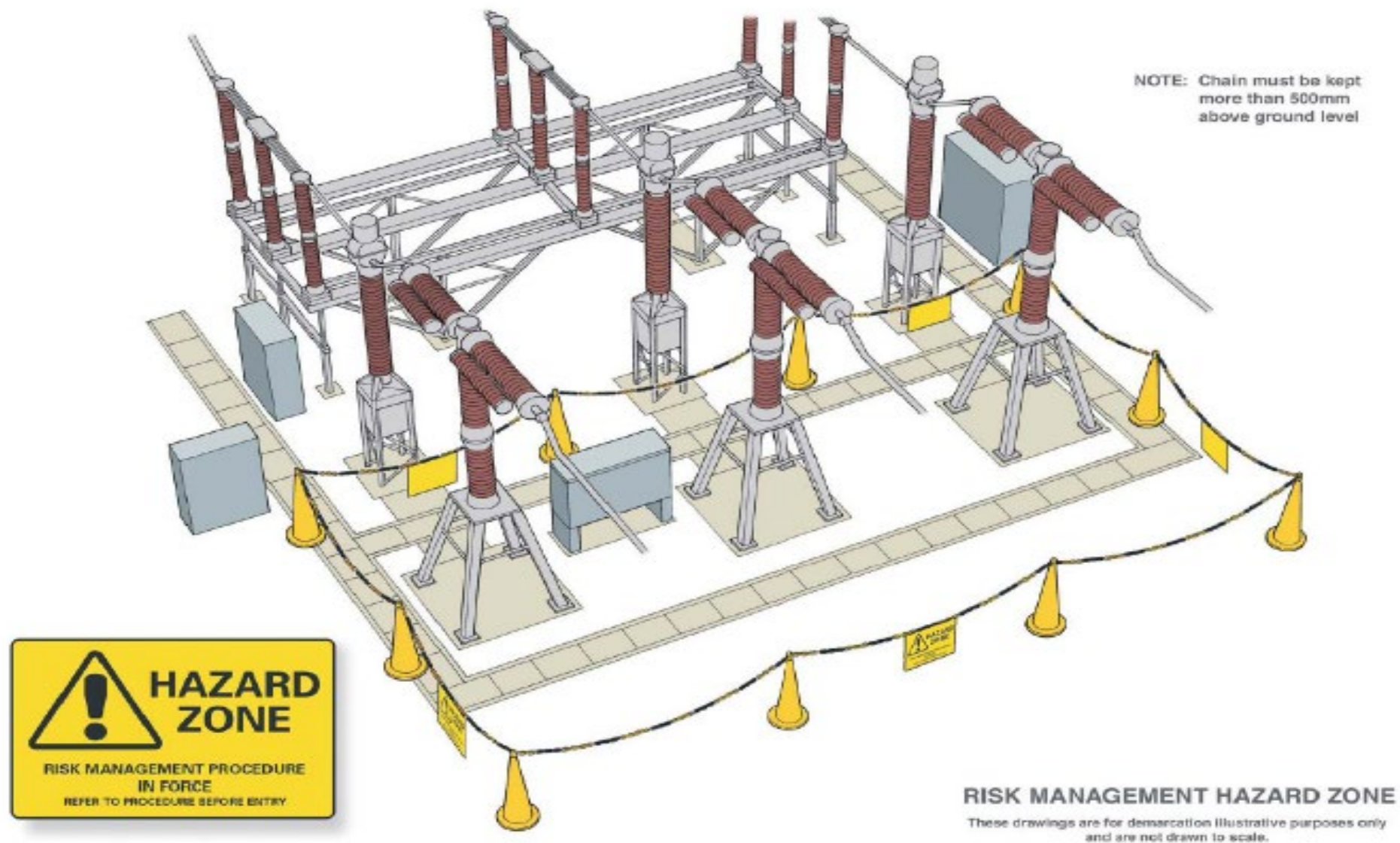
Appendix C2 – Example of Demarcation for a Risk Management Hazard Zone

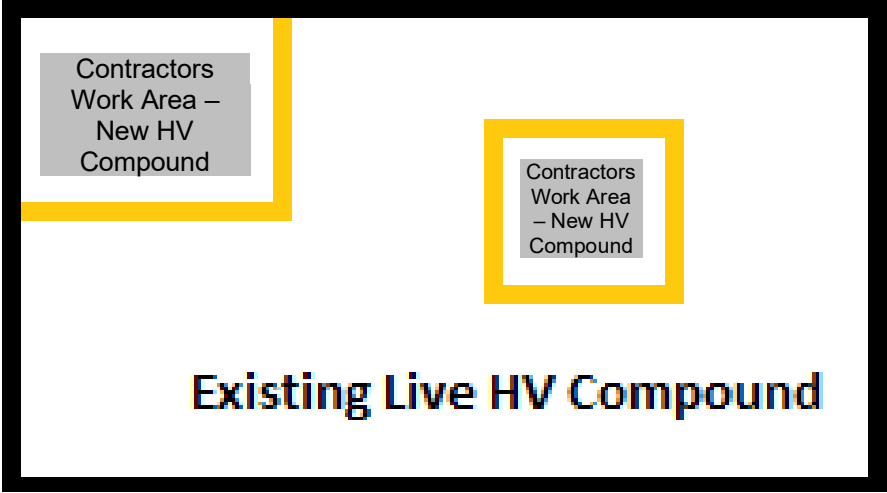
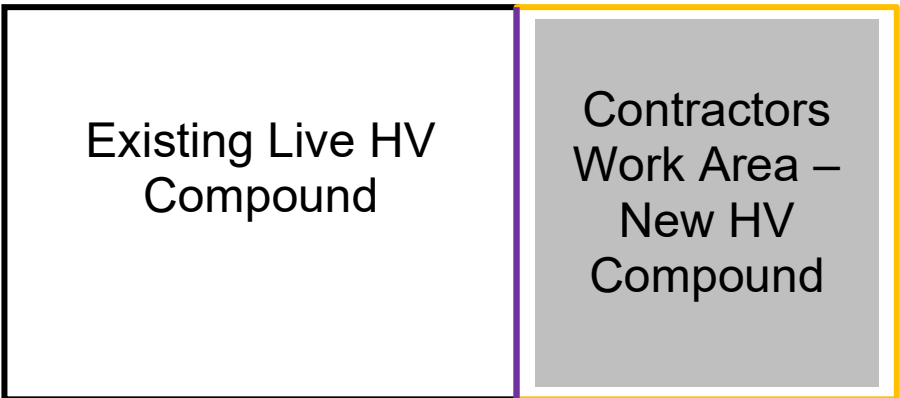

Appendix D – Examples of Contractors Work Areas
D1 – Contractors Work Area – ‘Off Safety Rules’

 <p style="text-align: center; font-weight: bold; color: blue;">Existing Live HV Compound</p> <p>Should an Off Safety Rules Contractor’s Work Area, that is delineated in line with the CDM Regulations, be required within a Live HV Compound, its position and type shall be recorded and agreed by a Senior Authorised Person.</p>	 <p>Where a Contractor’s Work area is Off Safety Rules, the delineation of that area shall be in line with the CDM Regulations. It shall be appropriately stable and secure based on a Risk assessment and agreed by the Senior Authorised Person. If and when the internal fence line (purple line) between the two compounds needs to be removed, then adequate temporary delineation will be added, that may include Safety Rule work area Demarcation should National Grid Safety Document(s) be required.</p>
<p><u>All</u> ‘Contractors Work Area’s’ shall be delineated with:</p> <ul style="list-style-type: none"> • Freestanding, stable and secure equipment • A Controlled Access Point with displayed CDM / Site information • Suitable pedestrian / vehicle access points • Suitable signage displayed at intervals around the area • Clearly distinguishable (from Safety Rules Demarcation) equipment – unless the Contractor’s and Safety Rules work areas are the same size. 	<p>Examples of acceptable Contractor Work Area delineation equipment (not exhaustive)</p> 

D2 – Contractors Work Area – ‘Where Contractors Work Area and Safety Rules Demarcation Area are the same size’

Example 1 – Acceptable demarcation.

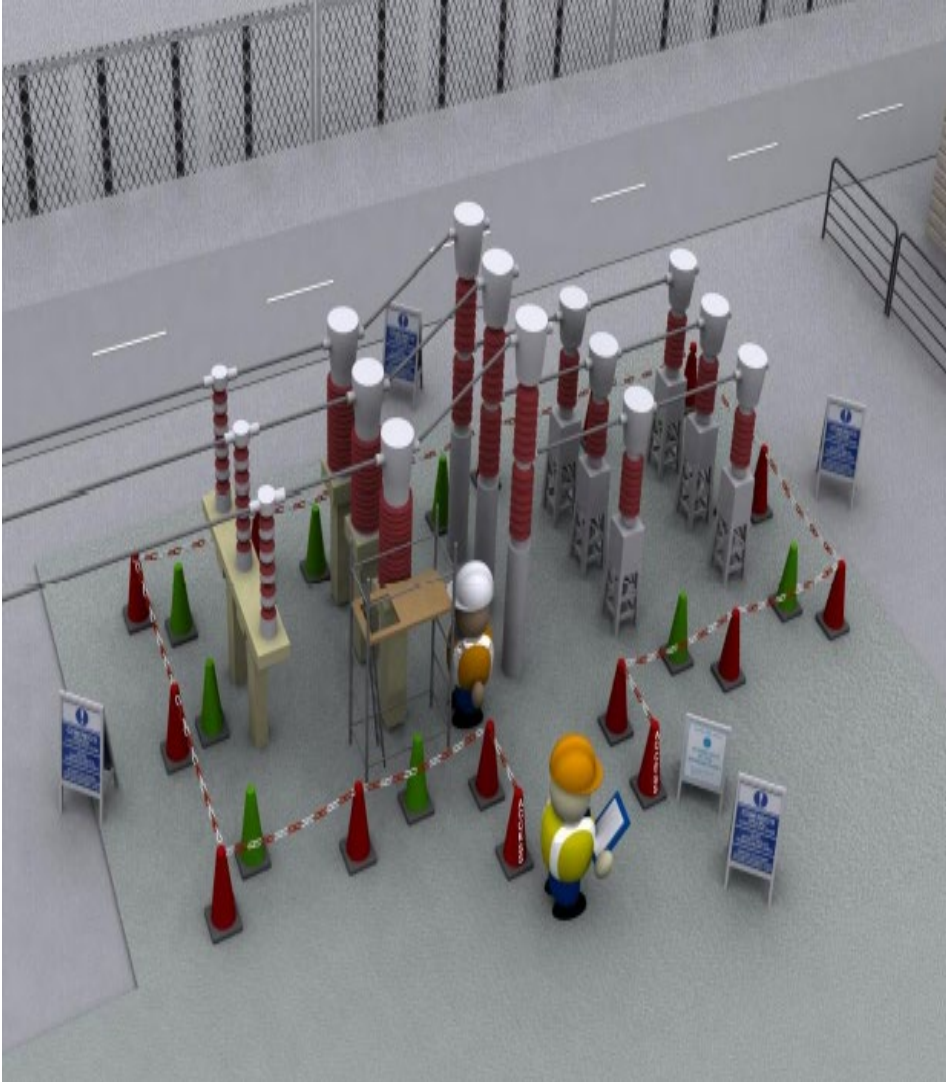

Example 2 – Contractors demarcation (temporary fencing).



D3 – Contractors Work Area – ‘Where a Safety Rules Demarcation Area is inside a Contractor’s Work Area’



Appendix E – Safety Notices

SAFETY NOTICES



ACCESS PROHIBITION NOTICE
WRAP ROUND
OR NOTICE



ELECTRICAL
DANGER NOTICE
WRAP ROUND
OR NOTICE



MECHANICAL
DANGER NOTICE
WRAP ROUND
OR NOTICE

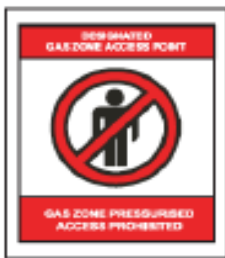

DESIGNATED
GAS ZONE ACCESS POINT NOTICE
(DISPLAYING GAS ZONE
PRESSURISED
ACCESS PROHIBITED)



VENTED GAS ZONE
ACCESS POINT NOTICE
(DISPLAYING GAS ZONE VENTED
ACCESS PERMISSIBLE)



TESTING AREA
NO ENTRY



RISK MANAGEMENT HAZARD ZONE
NOTICE



KEEP CLEAR OVERHEAD
LIVE EQUIPMENT NOTICE



ACCESS POINT NOTICE

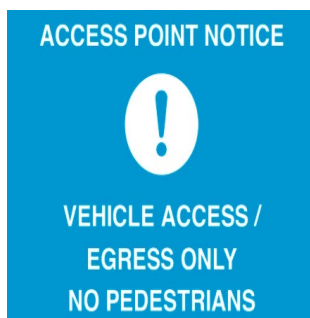

Vehicle Access Point Notice

Appendix F - Authorisation Matrix for Contractors Personnel

Contractors appointment under this NSI shall be limited to the following sections.

Contractor Personnel	Person	Competent Person	Authorised Person	Senior Authorised Person
Sections		All Sections		